

DX3

SINGLE AXIS SERVO DRIVE
 Conventional Version

USER MANUAL

About this Manual

Purpose

This manual provides the information required for the Selection, Wiring, Connection, Settings, Trial Operation, Tuning and Functions of the DX3 Series AC Servo Drive with pulse references (referred to as **DX3**).

Read and understand this manual to ensure correct usage of the product.

Terms and Abbreviations

Terms that may be used in this manual are defined as follows.

Term	Meaning
Motor	The Rotary Servo Motor
Drive	A Servo Drive, which is used for controlling the Rotary Servo Motor
Servo System	A Servo Control System consisting of a master controller, drive, motor and peripheral devices
Servo ON	Supplying power to the Motor
Servo OFF	Not supplying power to the Motor
ESView	The software tool for setting up and adjusting the drive, which is installed in the PC

Abbreviations that may be used in describing EtherCAT or CANopen as well as their meanings are defined as follows.

Abbreviation	Meaning
APRD	Auto-increment Physical Read
APWR	Auto-increment Physical Write
APRW	Auto-increment Physical Read/Write
ARMW	Auto-increment Physical Read/Multiple Write
BRD	Broadcast Read
BRW	Broadcast Read/Write
BWR	Broadcast Write
CiA	CAN in Automation
CoE	CAN application protocol over EtherCAT
DC	Distributed Clocks
EEPROM	Electrically Erasable Programmable Read Only Memory
ESC	EtherCAT Slave Controller





Abbreviation	Meaning
ESI	EtherCAT Slave Information
ESM	EtherCAT State Machine
FMMU	Fieldbus Memory Management Unit
FPRD	Configured Address Physical Read
FPWR	Configured Address Physical Write
FPRW	Configured Address Physical Read/Write
FRMW	Configured Address Physical Read Multiple Write
LRD	Logical memory Read
LWR	Logical memory Write
LRW	Logical memory Read/Write
OD	Object Dictionary
OP	Operational state of EtherCAT state machine
PDO	Process Data Object
PREOP	Pre-Operational state of EtherCAT state machine
RxPDO	Receive PDO, i.e. the process data that the ESC will receive
SAFEOP	Safe-Operational state of EtherCAT state machine
SDO	Service Data Object
SyncManager	Synchronization Manager
TxPDO	Transmit PDO, i.e. the process data to be sent by the ESC

Data types and scopes that may be used in this manual are defined as follows.

Abbreviation	Data type	Scope
INT8	Signed 8 bit	- 128 ~ + 127
INT16	Signed 16 bit	- 32768 ~ + 32767
INT32	Signed 32 bit	- 2147483648 ~ + 2147483627
UINT8	Unsigned 8 bit	0 ~ 255
UINT16	Unsigned 16 bit	0 ~ 65535
UINT32	Unsigned 32 bit	0 ~ 4294967295
STRING	String value	-

Symbols

The symbols that may be found in this document are defined as follows.

Symbol	Description
 DANGER	Indicates a hazard with a high level of risk that, if not avoided, will result in death or serious injury.
 WARNING	Indicates a hazard with a medium or low level of risk which, if not avoided, could result in minor or moderate injury.
 CAUTION	Indicates a potentially hazardous situation that, if not avoided, could cause equipment damage, data loss, and performance degradation, or unexpected results.
 IMPORTANT	Indicates precautions or restrictions that must be observed. Also indicates alarm displays and other precautions that will not result in machine damage.
 NOTE	Provides additional information to emphasize or supplement important points of the main text.

The names of reverse signals (ones that are taken effect when low) are written with a forward slash (/) before the signal abbreviation. For example:

$$\overline{\text{S-ON}} = /\text{S-ON} \qquad \overline{\text{P-CON}} = /\text{P-CON}$$

Parameters are referenced as PnXXX where XXX refers to a unique number. Some parameters have multiple functions encoded within a single parameter. For these parameters, sub-indices are used to reference the multiple functions.

For example:

- Pn112 Speed Feedforward - is a single value without any sub-indices
- Pn000 Basic Function Selection 0 - is made up of 4 sub-indexes describing different functions
 - Pn000.0 Servo ON
 - Pn000.1 Forward Drive Prohibit Input (P-OT)
 - Pn000.2 Reverse Drive Prohibit Input (N-OT)
 - Pn000.3 Reserved parameter (Do not change)

Safety Precautions

General Precautions



- Never remove covers, cables, connectors, or optional devices while power is being supplied to the Drive.
- Never connect a three-phase power supply to the terminals U, V, and W of the driver.
- Wait for five minutes after turning the power supply OFF and then make sure that the CHARGE indicator is not lit before starting wiring or inspection work.

Never touch the power supply terminals after turning OFF the power supply while the CHARGE lamp is lit, because high voltages may still be present in the Drive.



- Use a power supply that is appropriate for the product, check number of phases, voltage, frequency, and AC/DC type.
 - Connect the ground terminals on the Drive and Motor to ground poles according to local electrical codes.
 - Never damage, pull on, apply excessive force to, place heavy objects on, or pinch cables.
 - Never attempt to disassemble, repair, or modify the product.
 - Make sure that the device in an emergency stop state at any time when the product has been connected to the machine and ready for the operation.
 - Never touch inside the Drive.
-



- The Drive heat sinks, regenerative resistors, Motor, and other components can be very hot while power is ON or soon after the power is turned OFF. Implement safety measures, such as installing covers, so that hands and parts such as cables do not come into contact with hot components.
 - For the control power supply, use a power supply device with double insulation or reinforced insulation.
 - Never use the product in an environment that is subject to water, corrosive gases, or flammable gases, or near flammable materials.
 - Never attempt to use a Drive or Motor that is damaged or that has missing parts.
 - Install external emergency stop circuits that shut OFF the power supply and stops operation immediately when an error occurs.
 - In locations with poor power supply conditions, install the necessary protective devices (such as AC reactors) to ensure that the input power is supplied within the specified voltage range.
 - Always use a Noise Filter to minimize the effects of electromagnetic interference.
 - Always use a Motor and Drive in one of the specified combinations.
 - Never touch a Drive or Motor with wet hands.
-

Storage Precautions



- Follow all instructions on the packages, and never place an excessive load on the product during storage.
 - Never install or store the product in any of the following locations:
 - locations that are subject to direct sunlight.
 - locations that are subject to ambient temperatures exceed product specifications.
 - locations that are subject to relative humidity exceed product specifications.
 - locations that are subject to corrosive or flammable gases.
 - locations that are subject to dust, salts, or iron powder.
 - locations that are subject to water, oil, or chemicals.
 - locations that are subject to vibration or shock exceeds product specifications.
 - locations that are subject to radiation.
-

Installation Precautions



- Install the Drive in a control cabinet that provides fire and electrical protection.
 - Install the Drive and Motor in a way that will support their mass.
 - Never install or store the product in any of the following locations:
 - locations that are subject to direct sunlight.
 - locations that are subject to ambient temperatures exceed product specifications.
 - locations that are subject to relative humidity exceed product specifications.
 - locations that are subject to corrosive or flammable gases.
 - locations that are subject to dust, salts, or iron powder.
 - locations that are subject to water, oil, or chemicals.
 - locations that are subject to vibration or shock exceeds product specifications.
 - locations that are subject to radiation.
 - Never allow any foreign matter to enter a Drive or a Motor with a Cooling Fan.
 - Never cover the outlet from cooling fan of Drive or Motor.
 - Never step on or place a heavy object on the product.
 - Install the Drive in the specified orientation.
 - Provide the specified clearances between the Drive and the control cabinet as well as with other devices.
-

Wiring Precautions



- Never bypass the electromagnetic contactor in the wiring between the Drive and the Motor.
- Firmly connect the power terminal to the Motor terminal.
- Provide an adequate air gap around the Drive installation.
- Use shielded twisted-pair cables or screened unshielded multi-twisted-pair cables for I/O Signal Cables and Encoder Cables.
- The wiring length of the encoder is up to 20 meters.
- Minimize the frequency that the power supply is turned ON and OFF.

Operation Precautions



- In order to prevent accidents, please test the Motor with no load (not connected to the Drive shaft).
- When starting to operate on the supporting machine, set the user parameters that match the machine in advance.
- Note that the signals for the Forward Drive Prohibit (P-OT) and the Reverse Drive Prohibit (N-OT) are disabled during JOG operation.
- When overtravel occurs, the power supply to the Motor is turned OFF and the brake is released. If the Motor is used to drive a vertical load, set the Motor to enter a 'zero-clamped' state after the Motor stops. Also, install safety devices (such as an external brake or counterweight) to prevent the moving parts of the machine from falling.
- If not using auto-tuning, make sure that an appropriate moment of inertia ratio is setup to avoid vibration.
- If an alarm occurs, reset it after troubleshooting the cause and ensuring safety.
- Never use the brake of the Motor for normal braking.

Maintenance Precautions



- Wiring and inspections must be performed only by qualified engineers.
- Disconnect all connections to the Drive when testing the insulation resistance of the Drive.
- Never use gasoline, thinner, alcohol, acid or alkaline detergent to avoid discoloration or damage to the casing.
- When replacing the Drive, transfer the user parameters from the replaced Drive to new Drive.
- Never change the wiring while the power is on.
- Never disassemble the Motor without permission.

Disposal Precautions



When disposing of the product, treat it as ordinary industrial waste. However, local ordinances and national laws must be observed. Implement all labeling and warnings as required.

Contents

About this Manual	i
Purpose.....	i
Terms and Abbreviations.....	i
Symbols.....	iii
Safety Precautions	iv
General Precautions.....	iv
Storage Precautions	v
Installation Precautions.....	v
Wiring Precautions.....	vi
Operation Precautions	vi
Maintenance Precautions	vi
Disposal Precautions	vii
Contents.....	viii
Chapter 1 DX3 Servo Drive	1-1
1.1 Product Features	1-1
1.2 Interpreting the Nameplate	1-2
1.3 Model Designations.....	1-2
1.4 Part Names	1-3
1.5 Ratings and Specifications	1-9
1.6 External Dimensions	1-12
1.7 System Configuration	1-15
Chapter 2 Installation	2-1
2.1 Installation Precautions	2-1
2.2 Mounting Types and Orientation	2-1
2.3 Mounting Hole Dimensions	2-2
2.4 Mounting Interval.....	2-3
Chapter 3 Wiring and Connecting	3-1
3.1 Precautions for Wiring	3-1
3.2 Basic Wiring Diagrams	3-7
3.3 Terminals Arrangements.....	3-10
3.4 Wiring the Power Supply to Drive.....	3-15
3.5 Wiring the Encoder.....	3-38
3.6 I/O Signal Connections	3-45
3.7 USB Communication Cable.....	3-50
Chapter 4 Basic Settings	4-51
4.1 Panel Operator.....	4-51
4.2 ESView V4.....	4-66
Chapter 5 Application Functions	5-1
5.1 Power Supply	5-1
5.2 Motor Rotation Direction	5-2
5.3 Overtravel Limit	5-2
5.4 Motor Stopping Methods.....	5-4
5.5 Holding Brake	5-6

5.6 Encoder Settings.....	5-10
5.7 IO Signal Allocation.....	5-13
5.8 Control Mode Selection.....	5-17
5.9 Speed Control.....	5-19
5.10 Position Control.....	5-25
5.11 Torque Control.....	5-36
5.12 Internally Set Speed Control.....	5-42
5.13 PCP Control.....	5-46
5.14 Selection of Control Mode Combinations.....	5-53
5.15 Torque Limit.....	5-56
5.16 Homing.....	5-60
5.17 Other Output Signals.....	5-66
Chapter 6 CANopen Communication.....	6-1
6.1 Wiring and Connection.....	6-1
6.2 CANopen Overview.....	6-3
6.3 Unit Conversion.....	6-19
6.4 Position Control Function.....	6-24
6.5 Device Control.....	6-28
6.6 Control Mode.....	6-35
6.7 HOMING MODE.....	6-36
6.8 PROFILE VELOCITY MODE.....	6-48
6.9 PROFILE TORQUE MODE.....	6-53
6.10 PROFILE POSITION MODE.....	6-56
6.10.1 Flow Chart of PROFILE POSITION MODE.....	6-56
6.11 INTERPLATION POSITION MODE.....	6-63
6.11.1 Flow Chart of INTERPLATION POSITION MODE.....	6-63
6.12 Torque Limit Function.....	6-68
6.13 DIGITAL INPUT /OUTPUT.....	6-69
6.14 Functions of TouchProbe.....	6-70
6.15 Soft Limit Function.....	6-75
Chapter 7 Trial Operation.....	7-1
7.1 Preparations for Trail Operation.....	7-1
7.2 Inspections and Confirmations.....	7-1
7.3 Motor Operation without a Load.....	7-1
7.4 Motor Operation with a Load.....	7-5
7.5 Program Jogging.....	7-6
Chapter 8 Tuning.....	8-1
8.1 Overview.....	8-1
8.2 Tuning Modes.....	8-4
8.3 Tuning Tools.....	8-10
8.4 Feedback Speed Selection.....	8-29
8.5 Additional Adjustment Functions.....	8-30
8.6 Vibration Suppression.....	8-38
8.7 Diagnostic Tools.....	8-43
Chapter 9 MODBUSCommunications.....	9-1
9.1 Communication Wiring.....	9-1
9.2 Setting Communication Parameters.....	9-1
9.3 MODBUS Communication Protocol.....	9-2

Chapter 10 Alarm Displays	10-1
10.1 Alarm Classifications.....	10-1
10.2 Alarm Detailed.....	10-2
Chapter 11 Parameters	11-22
11.1 Interpreting the Parameter Lists	11-22
11.2 Parameters Detailed.....	11-23
Chapter 12 Object Dictionary	12-1
Revision History	12-1

Chapter 1 DX3 Servo Drive

1.1 Product Features

As a new single-axis AC servo product from Trio, DX3 is designed with its excellent performance and practical control functions to create a complete set of solutions with the best cost performance for customers.

Matching with the MX servo motors, compatible with mainstream controllers, it offers high-speed, high-precision, and high-performance machine solutions.

DX3 has the following outstanding features.

- CANopen supported
- Compact size
- Zero stacking gap installation
- 200 V ac from 50 W to 2 kW
- 400 V ac from 1.0kW to 7.5kW
- Compatible with MX servo motors

Optional 17-bit incremental encoder/17-bit absolute encoder (magnetic) and 20-bit incremental/23-bit absolute encoder (photoelectric)

- Comprehensive tuning technology including Auto-tuning function, adaptive vibration suppression, friction compensation

1.2 Interpreting the Nameplate

ESTUN **SERVODRIVE**
MODEL ED3L-04AMA

	AC-INPUT	AC-OUTPUT
Phase	1PH	3PH
Voltage	200-240V	0-240V
Freq	50/60Hz	0-500Hz
F.L.C(1PH)	3.3A	2.9A
Power		0.4KW

S/N: 123456789ABCDE

Estun Automation Co., Ltd.
MADE IN CHINA

请务必熟读使用说明书，并按其规定进行操作。
 Read manual carefully and follow the direction.

危险
 WARNING 切断电源 5 分钟内，请勿触摸驱动器端子和配线！有触电的危险。
 Disconnect all power and wait 5 min. before servicing. May cause electric shock.
 Débranchez toute l'alimentation et attendez 5min. avant l'entretien. peut provoquer un choc électrique.

注意
 CAUTION 请勿触摸散热片！有烫伤危险。
 Do not touch heatsink. May cause burn. ne touchez pas le radiateur. peut cayer des brûlures.

接地端子必须接地。
 Use proper grounding techniques. techniques de mise à la terre appropriées.

1.3 Model Designations

ED3L - 02 A M A

Summa ED3L Serial Servodrive

Sign	Spec.
A5	0.05 kW
01	0.1 kW
02	0.2 kW
04	0.4 kW
08	0.75 kW
10	1 kW
15	1.5 kW
20	2 kW
30	3 kW
50	5 kW
75	7.5 kW

Sign	Spec.
E	EtherCAT
M	Pulse, CANopen
P	Profinet

Sign	Spec.
A	200 V
D	400 V

Sign	Spec.
A	Serial encoder
C	Linear encoders

1.4 Part Names

200VAC Rated power from 50W to 400W

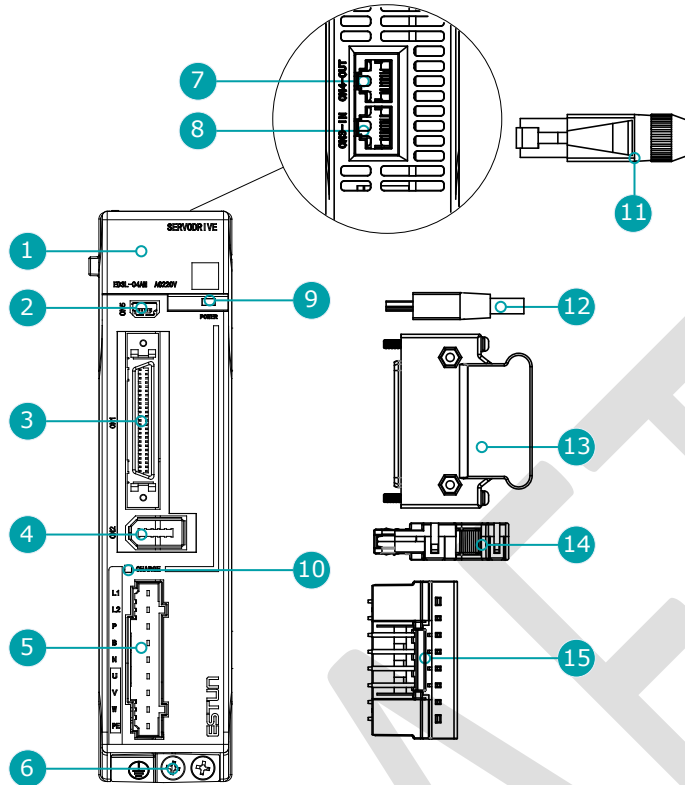

No.	Name	Description
1	Panel Operator	A module for Servo status displays and parameter settings
2	USB Connector	Connects a computer for ESView V4
3	IO Signal Connector	Connects to sequence I/O signals
4	Encoder Connector	Connects to the encoder in the Motor
5	Main Circuit and Motor Connector	L1, L2: main power input terminals P, N: common DC bus terminals P, B: external regenerative resistor terminals U, V, W: motor power terminals PE: ground terminal
6	Grounding Terminal	Connects to the ground terminal of the Motor main circuit cable
7	External communication output indicators	Output connector of the external communication cable Note: A dust plug has been mounted at the factory.
8	External communication input indicators	Input connector of the external communication cable Note: A dust plug has been mounted at the factory.
9	POWER Indicator Lamp	Lit while the control circuit power is being supplied

No.	Name	Description
10	CHARGE Indicator Lamp	Lit while the main circuit power is being supplied Note: Even if you turn OFF the main circuit power supply, this indicator will be lit as long as the internal capacitor remains charged. Never touch the main circuit or Motor terminals while this indicator is lit, in case the electric shock.
11	External communication Terminals	Standard RJ-45 terminal
12	USB Terminals	Standard Mini USB Type-B
13	IO Signal Terminals	Connection terminals for sequence IO signals
14	Encoder Terminals	Connection terminals for the encoder cable in the Motor
15	Main Circuit and Motor Terminals	Connection terminals for power input and motor power

200VAC Rated power from 750W to 2kW

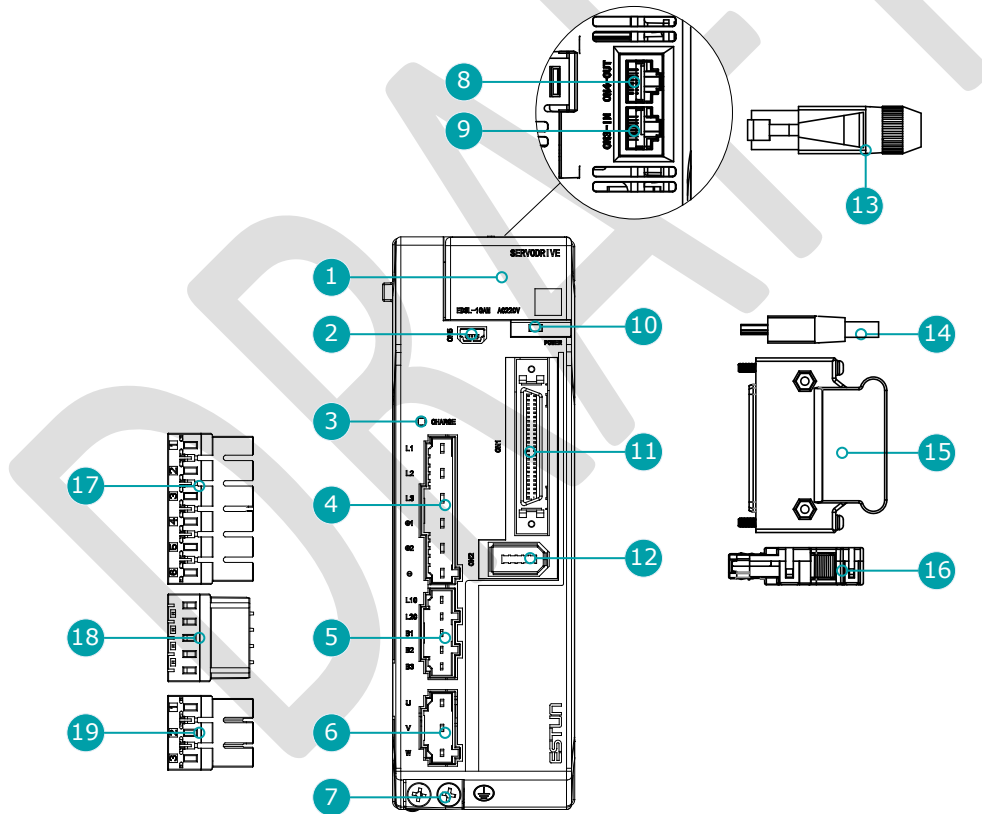

 NOTE

The figure above shows that the rated power from 750W to 1kW. The appearance and components of the product rated at 1.5kW to 2kW are the similar.

No.	Name	Description
1	Panel Operator	A module for Servo status displays and parameter settings
2	USB Connector	Connects a computer for ESView V4

No.	Name	Description
3	CHARGE Indicator Lamp	Lit while the main circuit power is being supplied Note: Even if you turn OFF the main circuit power supply, this indicator will be lit as long as the internal capacitor remains charged. Never touch the main circuit or Motor terminals while this indicator is lit, in case the electric shock.
4	Main Circuit Connector	<ul style="list-style-type: none"> • L1, L2, L3: main power input terminals • ⊕1, ⊕2, ⊖: DC terminals
5	Control Circuit Connector	<ul style="list-style-type: none"> • L1C, L2C: control power input terminals • B1, B2, B3: external regenerative resistor terminals
6	Motor Connector	Connects to a Motor main circuit cable
7	Grounding Terminal	Connects to the ground terminal of the Motor main circuit cable
8	External communication output indicators	Output connector of the external communication cable Note: A dust plug has been mounted at the factory.
9	External communication input indicators	Input connector of the external communication cable Note: A dust plug has been mounted at the factory.
10	POWER Indicator Lamp	Lit while the control circuit power is being supplied
11	IO Signal Connector	Connects to sequence I/O signals
12	Encoder Connector	Connects to the encoder in the Motor
13	External communication Terminals	Standard RJ-45 terminal
14	USB Terminals	Standard Mini USB Type-B
15	IO Signal Terminals	Connection terminals for sequence IO signals
16	Encoder Terminals	Connection terminals for the encoder cable in the Motor
17	Main Circuit Terminals	The connection terminals for the main circuit power supply
18	Control Circuit Terminals	The connection terminals for the control power supply
19	Motor Terminals	The connection terminals for the Motor main circuit cable

400VAC , rated power from 1kW to 5kW

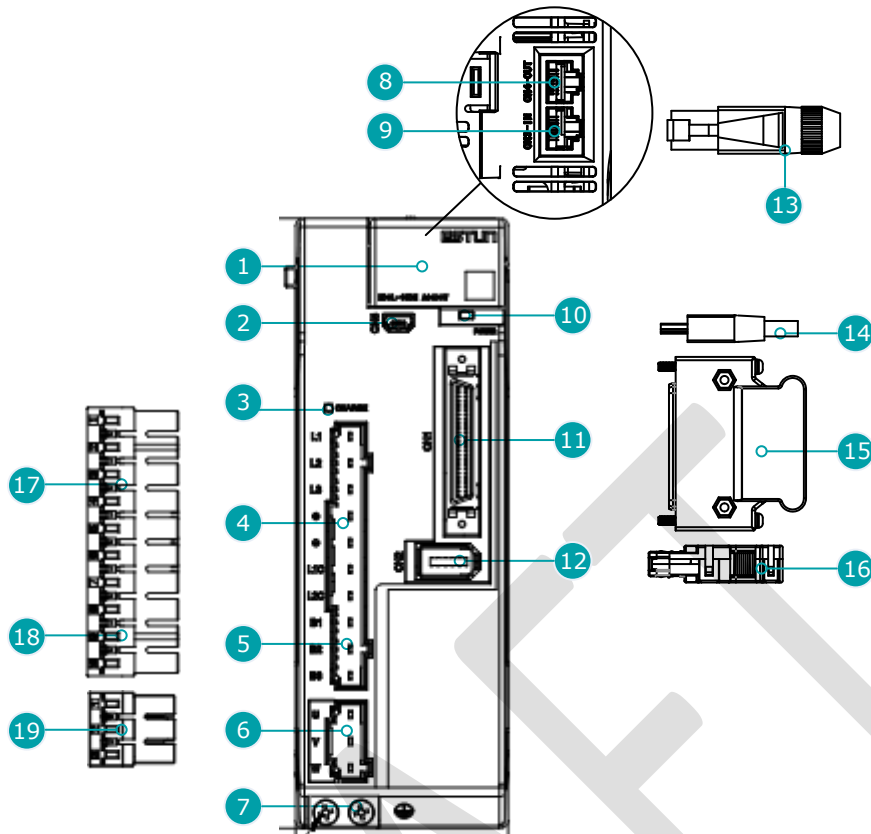

 NOTE

The figure above shows an example of a product with a rated power of 1kW to 1.5kW. Products with a rated power of 2kW~3kW are similar in appearance and have the same components.

No.	Name	Description
1	Panel Operator	A module for Servo status displays and parameter settings.
2	USB Connector	Socket for USB communication cable when using ESView V4 on PC.
3	CHARGE Indicator Lamp	Lights up when the main circuit is powered on. Note: If voltage remains in the capacitors inside the drive after the main circuit has been switched off, and the indicator lamp will be ON, do not touch the main circuit and motor terminals at this time to avoid electric shock.
4	Main Circuit Port	<ul style="list-style-type: none"> • L1, L2, L3: main power input terminals • ⊕1, ⊕2, ⊖: DC connectors
5	Control Circuit Port	<ul style="list-style-type: none"> • L1C, L2C: control power input terminals • B1, B2, B3: external regenerative resistor connectors
6	Motor Power Connection Port	Socket for motor power cable.
7	Grounding Terminal	Connected to the earth terminal of the motor power cable.
8	External Communication Output Connection Port	Socket for output signal connection of external communication cable.

No.	Name	Description
9	External Communication Input Connection Port	Socket for input signal connection of external communication cable.
10	POWER Indicator Lamp	Light up when the control circuit is powered on.
11	IO Signal Connection Port	Socket for IO signal connectors.
12	Encoder Connection Port	Socket for the encoder connectors of the motor.
13	External Communication Connector	Standard RJ-45 terminal.
14	USB Connector	Standard Mini USB Type-B.
15	IO Signal Connector	Connector for IO signal cables.
16	Encoder Connector	Connector for motor encoder cables.
17	Main Circuit Connector	Connector for the drive's main circuit cables.
18	Control Circuit Connector	Connector for the drive control circuit cables.
19	Motor Power Cable Connector	Connector for the motor power cables.

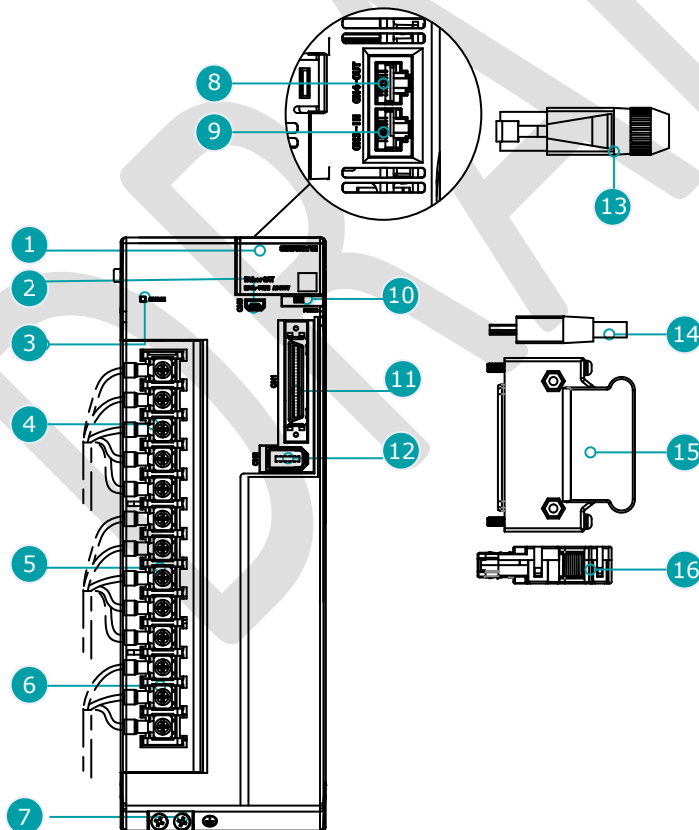
400VAC , rated power from: 5kW~7.5kW



No.	Name	Description
1	Panel Operator	A module for Servo status displays and parameter settings.

No.	Name	Description
2	USB Connector	Socket for USB communication cable when using ESView V4 on PC.
3	CHARGE Indicator Lamp	Lights up when the main circuit is powered on. Note: If voltage remains in the capacitors inside the drive after the main circuit has been switched off, and the indicator lamp will be ON, do not touch the main circuit and motor terminals at this time to avoid electric shock.
4	Main Circuit Port	<ul style="list-style-type: none"> • L1, L2, L3: main power input terminals • ⊕1, ⊕2, ⊖: DC connectors
5	Control Circuit Port	<ul style="list-style-type: none"> • L1C, L2C: control power input terminals • B1, B2, B3: external regenerative resistor connectors
6	Motor Power Connection Port	Socket for motor power cable.
7	Grounding Terminal	Connected to the earth terminal of the motor power cable.
8	External Communication Output Connection Port	Socket for output signal connection of external communication cable.
9	External Communication Input Connection Port	Socket for input signal connection of external communication cable.
10	POWER Indicator Lamp	Light up when the control circuit is powered on.
11	IO Signal Connection Port	Socket for IO signal connectors.
12	Encoder Connection Port	Socket for the encoder connectors of the motor.
13	External Communication Connector	Standard RJ-45 terminal.
14	USB Connector	Standard Mini USB Type-B.
15	IO Signal Connector	Connector for IO signal cables.
16	Encoder Connector	Connector for motor encoder cables.

1.5 Ratings and Specifications

Drive Model: DX3-		1A5A	101A	102A	104A	108A	110A	115A	120A
Continuous Output Current [Arms]		0.9	1.1	1.5	2.9	5.1	6.9	8.2	11.3
Instantaneous Maximum Output Current [Arms]		3.3	4.0	5.8	11.5	19.5	21.0	24.6	33.9
Power Supply Capacity [kVA]	Single-phase	0.2	0.3	0.6	1.2	1.9	2.6	4.0 (注)	-
	Three-phase	-	-	-	-	1.6	2.0	3.0	3.5

400VAC							
Drive Model: DX3-		110D	115D	120D	130D	150D	175D
Continuous Output Current [Arms]		3.6	5.0	7.1	12.0	17.0	27.3
Max Output Current [Arms]		10.9	17.7	24.7	37.8	53.0	70.7
Mains Power Equipment Capacity [kVA] (3-phase)		1.8	2.8	3.5	5.0	8.2	12.0

Input Power	200VAC		<ul style="list-style-type: none"> Single-phase AC 200V~240V, -15%~+10%, 50Hz/60Hz 3-phase AC200V~240V, -15%~+10%, 50Hz/60Hz (rated power \geq 0.75kW)
	400VAC		3-phase AC380V~440V, -15%~+10%, 50Hz/60Hz
Control Power	200VAC		Single-phase AC 200V~240V, -15%~+10%, 50Hz/60Hz
	400VAC		Single-phase AC 200V~440V, -15%~+10%, 50Hz/60Hz
Control Method			SVPWM
Feedback			Serial encoder: <ul style="list-style-type: none"> 17 bits incremental magnetoelectric encoders 17 bits absolute magnetoelectric encoders 20bitsIncremental encoder 23bitsAbsolute encoder
Environmental Conditions	Operation	Temperature	<ul style="list-style-type: none"> -5°C to 55°C (-5°C to 40°C for zero stacking gap installation)
		Humidity	5% to 95% (with no condensation)
	Storage	Temperature	-20°C to +85°C
		Humidity	5% to 95% (with no condensation)
	Protection Class		All terminals are installed in place to meet IP20
	Altitude		1,000 m or less
	Vibration Resistance		4.9m/s ²

	Shock Resistance	19.6m/s ²	
	Power System	TN System	
Mounting		Base-mounted	
Performance	Speed Control Range	1:5000	
	Coefficient of Speed Fluctuation	±0.01% of rated speed max. (For a load fluctuation of 0% to 100%)	
		0% of rated speed max. (For a load fluctuation of ±10%)	
		±0.1% of rated speed max. (For a temperature fluctuation of 25°C±25°C)	
Soft Start Time Setting	0s to 10s (Can be set separately for acceleration and deceleration.)		
Torque Control	Analog reference	Reference Voltage	±10VDC at rated torque (Variable setting range:±0 to 10VDC) Max. input voltage: ±12V
		Input Impedance	About 10MΩ or above
		Circuit Time Constant	10μs
	Torque selection	Inner setting	4 torque selections
Speed control	Analog reference	Reference Voltage	±10VDC at rated speed (Variable setting range:±0 to 10VDC) Max. input voltage: ±12V
		Input Impedance	About 10MΩ or above
		Circuit Time Constant	10μs
	Speed selection	Rotation Direction Selection	With /P-CON signal
		Inner setting	7 speed selections
Position Control	Pulse reference	Type	<ul style="list-style-type: none"> • Sign + pulse train • CCW + CW pulse train • 90° phase difference 2-phase (phase A + phase B)
		Form	Non-insulated linde driver (about + 5V), open collector
		Frequency	×1 multiplier: 4Mpps ×2 multiplier: 2Mpps ×4 multiplier: 1Mpps Open collector: 200Kpps Frequency will begin to decline when the duty ratio error occurs..
	PCP	Inner setting	32 position contacts
I/O Signals	Encoder Divided Pulse Output	Phase A, phase B, phase C: Line-driver output. Number of divided output pulses: Any setting is allowed.	

	Input Signals	Allowable voltage range: 24 VDC \pm 20% Number of input points: 10 (2 of them are high-speed optocoupler inputs, fixed as Touch Probe)
		Input Signals are S-ON (Servo ON), P-CON (Proportional Control), ALM-RST (Alarm Reset), CLR (Position Error Clear), P-OT (Forward Drive Prohibit), N-OT (Reverse Drive Prohibit), P-CL (Forward External Torque Limit), N-CL (Reverse External Torque Limit). Except TP1 and TP2, a signal can be allocated and the positive and negative logic can be changed.
	Output Signals	Allowable voltage range: 5 VDC to 30 VDC Number of output points: 4 (1 of them fixed for Servo Alarm)
		Output Signals are TGON (Rotation Detection), ALM (Servo Alarm), SRDY (Servo Ready), COIN (Positioning Completion), PAO (Encoder Divided Pulse, Phase A), PBO (Encoder Divided Pulse, Phase B), PCO (Encoder Divided Pulse, Phase C). Except ALM, a signal can be allocated and the positive and negative logic can be changed.
USB Communications	Interface	Personal computer (with ESView V4)
	Communications Standard	Conforms to USB2.0 standard (12 Mbps)
External communication (RJ45)		Serial communication standard, Modbus protocol
Display		Five 7-segment LEDs
Indicator Lamps		CHARGE, POWER
Panel Operator		4 Buttons
Regenerative Processing		<ul style="list-style-type: none"> Rated power from 50W to 400W must connect an external regenerative resistor. Rated power from 750W to 2kW are built-in.
Protective Functions		Overcurrent, Overvoltage, Undervoltage, Overload, Regeneration Error, Overspeed, etc.
Utility Functions		Alarm history, Jogging, Mechanical analysis, Load inertia identification, Auto-Tuning, etc.

NOTE: when using single-phase AC power for DX3-115A* drivers, reduce the load factor rating to 80%.

1.6 External Dimensions

Rated power from 50W to 400W

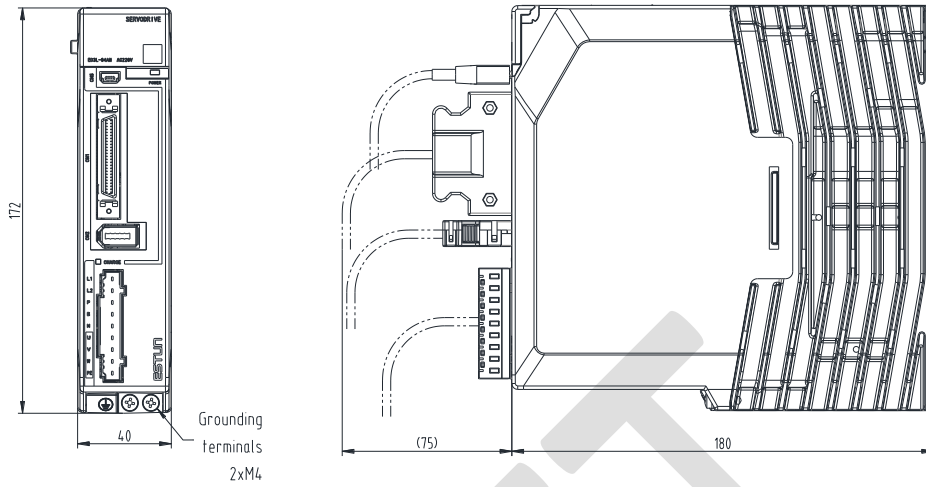

Rated power at 750W and 1kW

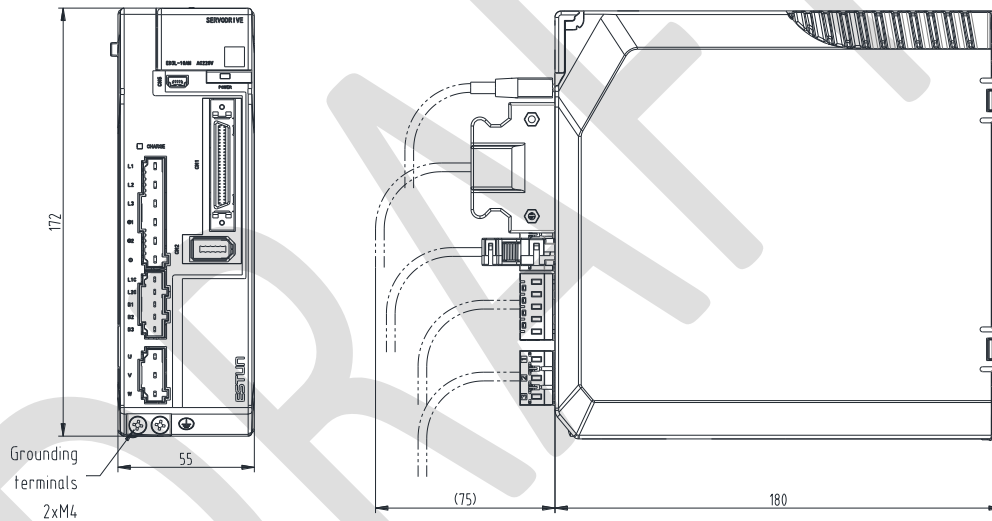

Rated power at 1.5kW and 2kW

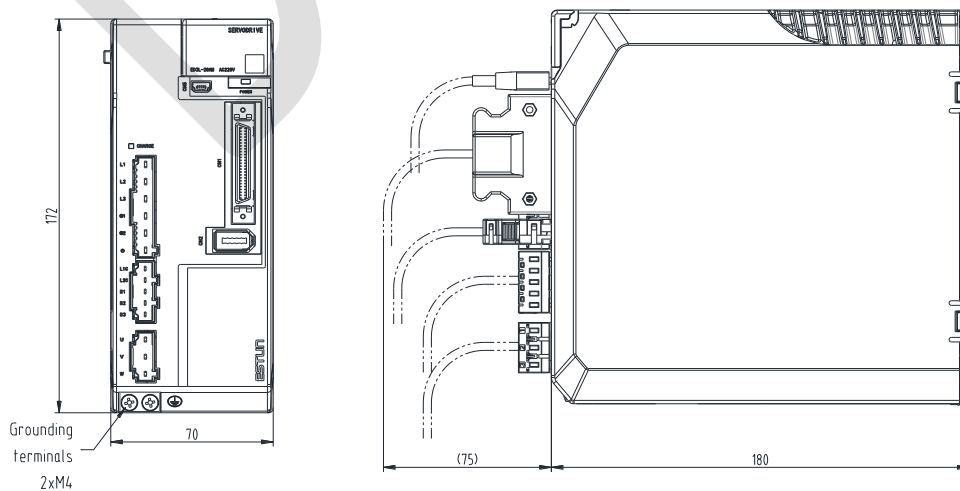

400VAC, rated power from 1kW to 1.5kW

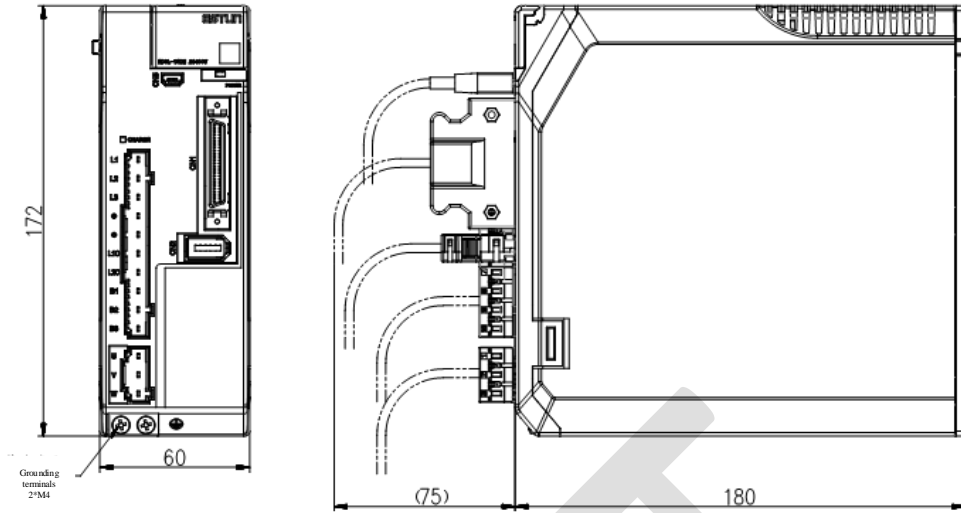

400VAC, rated power from 2kW to 3kW

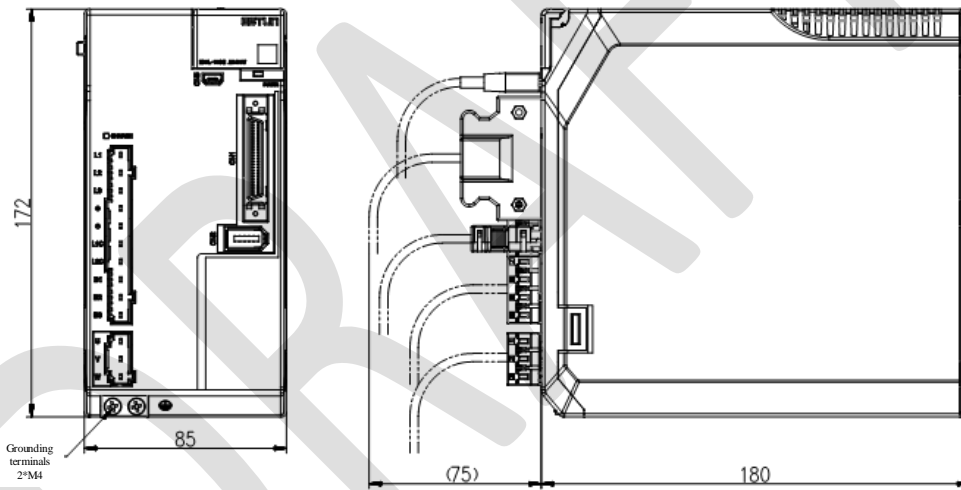

400VAC, rated power from 5kW to 7.5kW

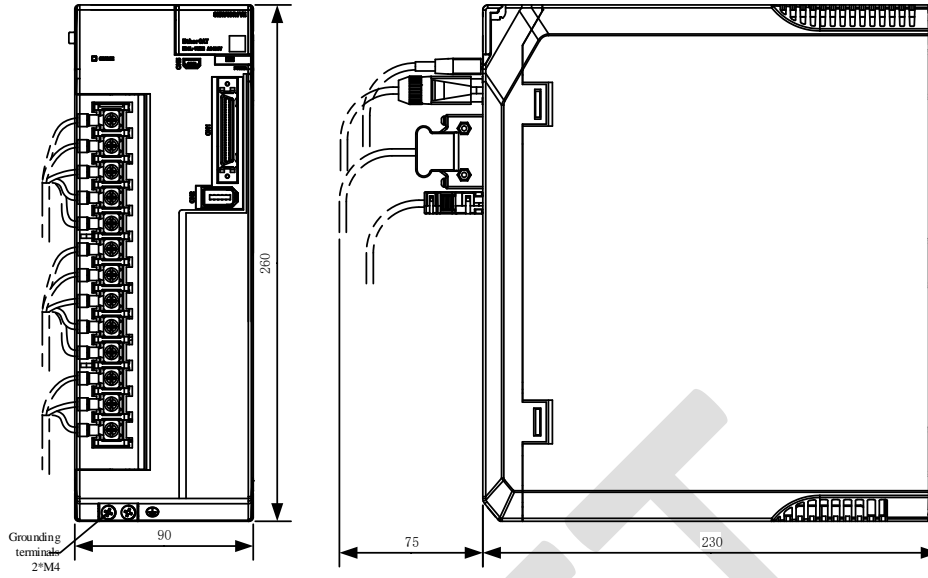

1.7 System Configuration

200VAC Rated power from 50W to 400W

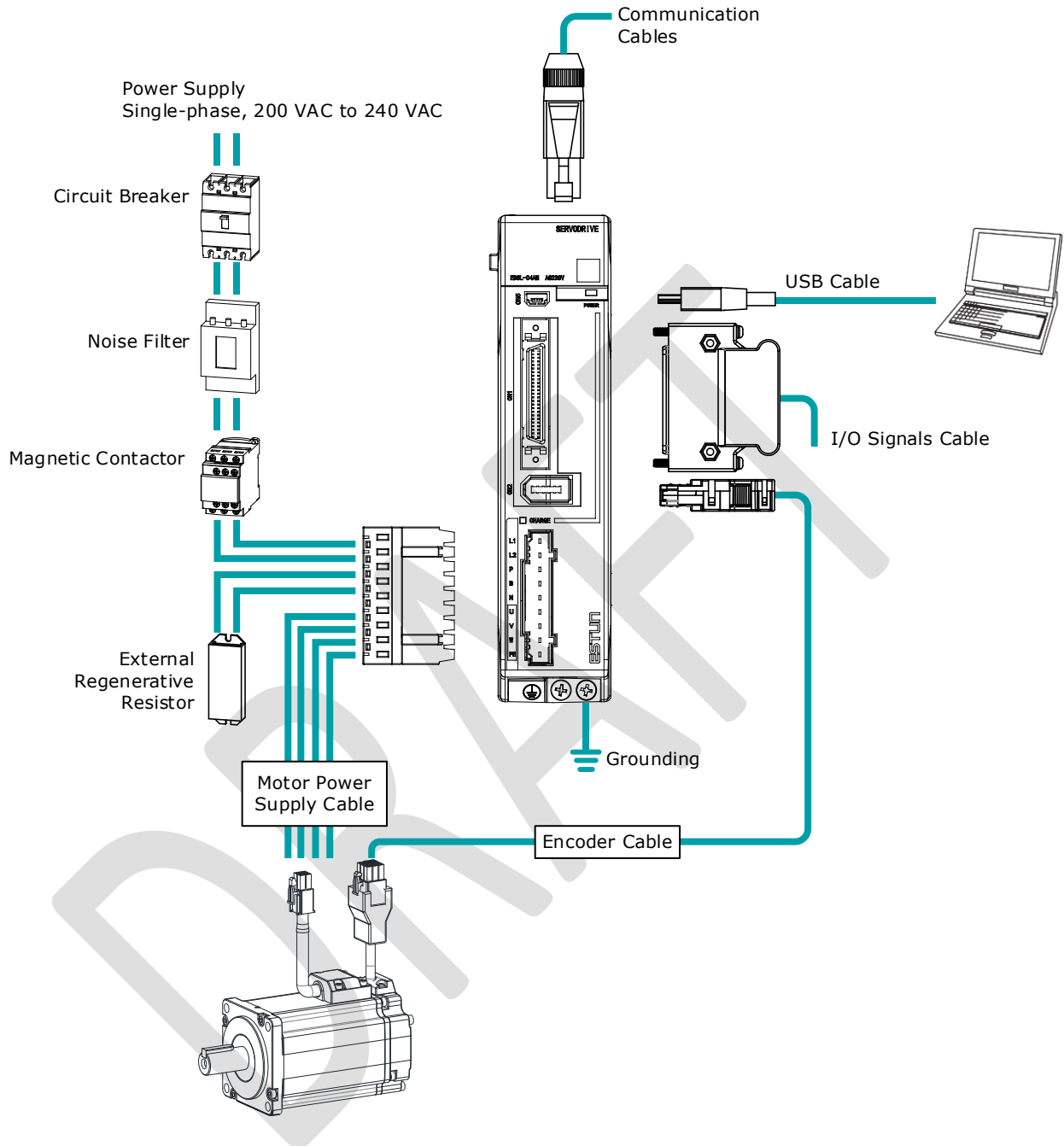

200VAC Rated power from 750W to 2kW

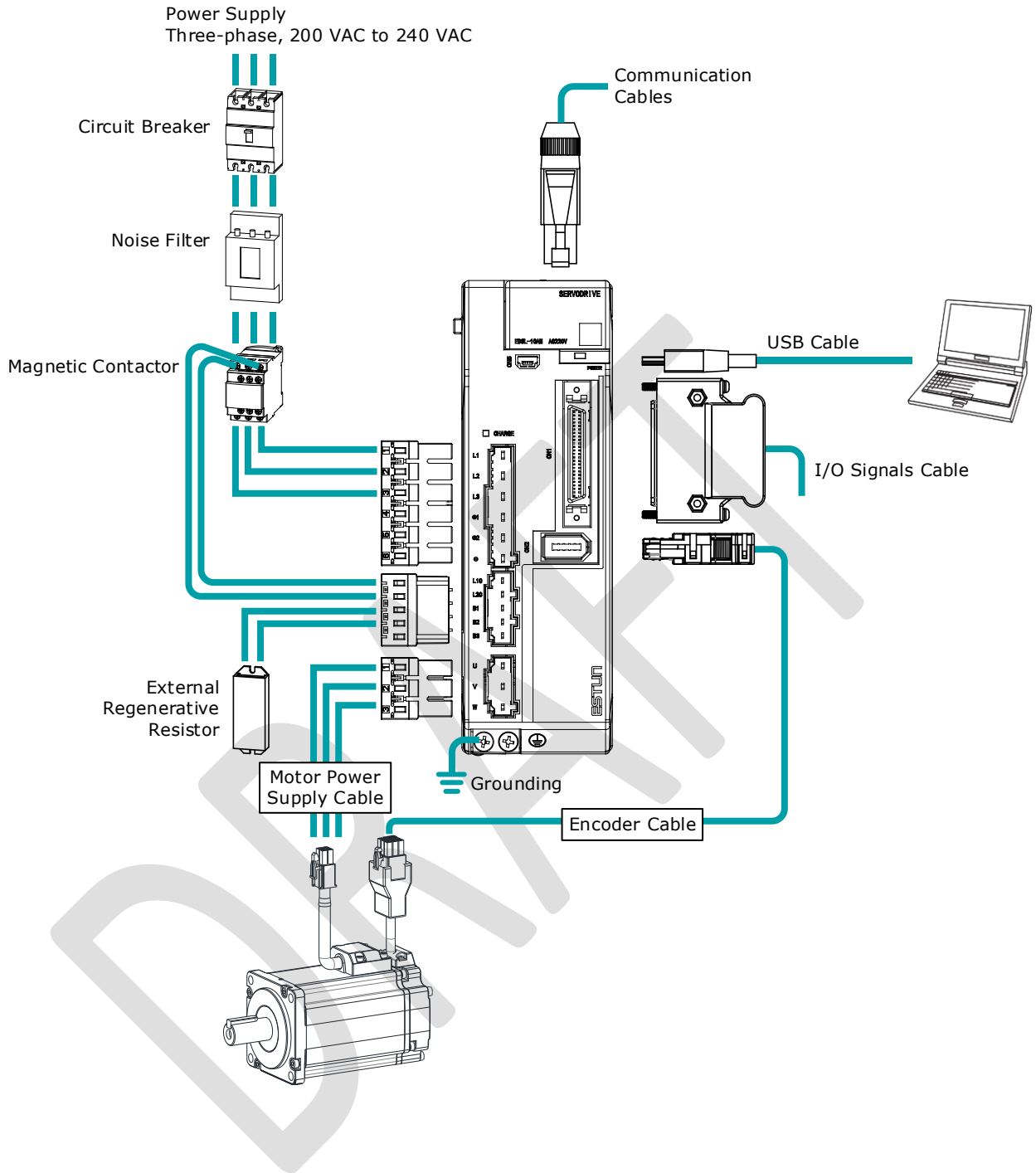

400VAC , Rated power from: 1kW~7.5kW

Take the 1kW drive as an example:

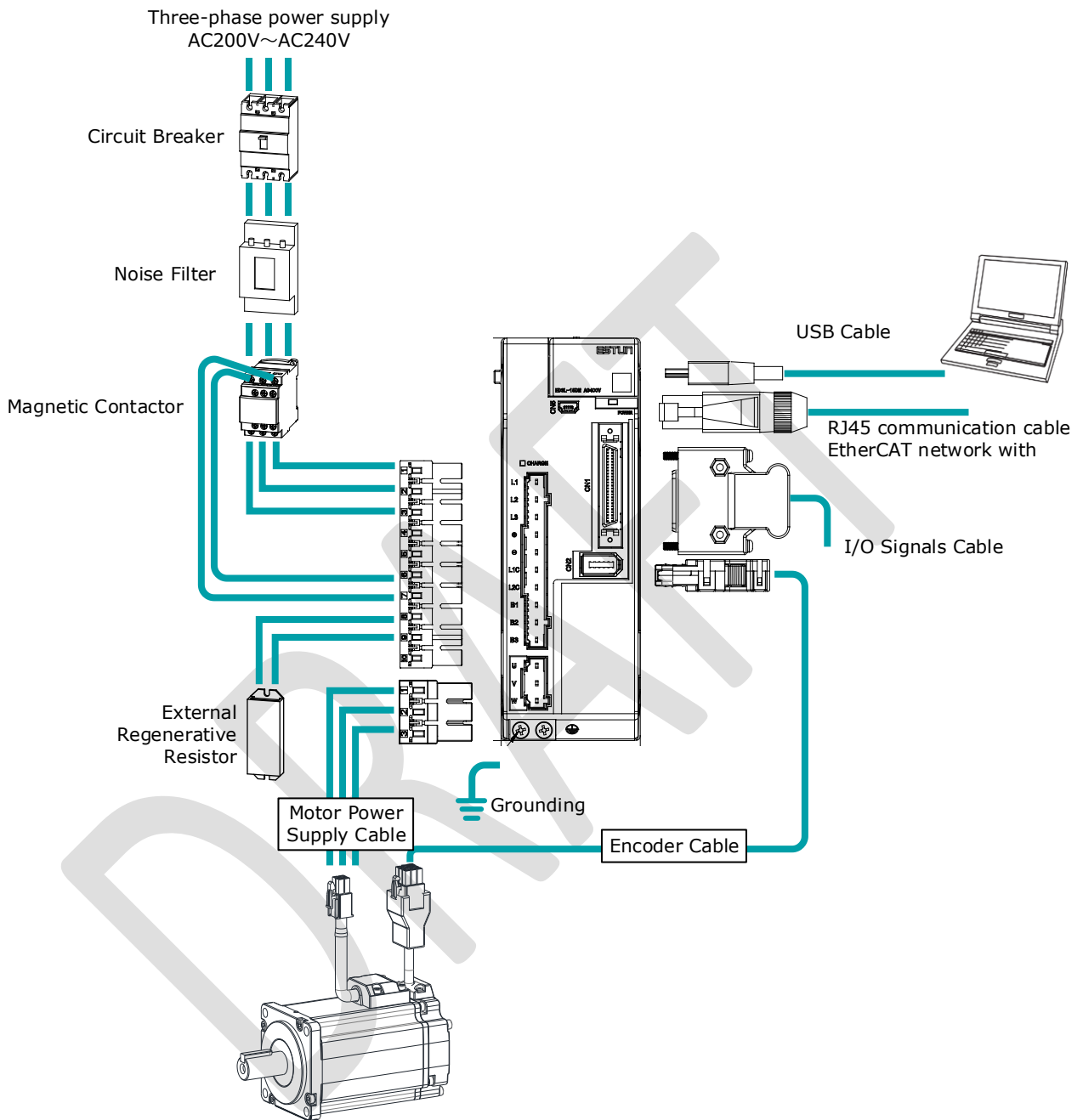

Minimum System Configuration

The minimum system configuration includes at least the following components.

Component Name	Description
Power Supply	Control power supply: (L1C,L2C) Single-phase AC 200V to 240V, -15% to +10%, 50Hz/60Hz Note: Single-phase power supply is used for 400W drive.
	Mains power supply (L1,L2,L3): three-phase AC 200V to 240V, -15% to +10%, 50Hz/60Hz
Circuit Breaker	Please use a Type C MCB to protect the power cord and to cut the circuit in the event of overcurrent. The minimum current rating of the circuit breaker varies with the drive model.
Noise Filter	Protection against external noise interference from the power cable, with the current rated at 10A or 20A.
Magnetic Contactor	On/off control of the input circuit.
External Regenerative Resistor	The minimum resistance value of the external regenerative resistor varies with the drive model.
Drive	DX3 Series Servo Drives.
Motor	Suitable for use with EM3A servo motors or EMG (at rated power \geq 1kW) servo motors.
Controller	The device provided for servo applications, mechanical motion programming.
PC software	ESView V4 software for PC.
Cables	Encoder cables, motor power cables, external communication cables, IO cables, etc.

Minimum system configuration of 400VAC

The minimum system configuration consists of at least the following components.

Component	Specification
Power supply	Control power supply: (L1C,L2C) Single-phase AC AC 220V~440V, -15%~+10%, 50Hz/60Hz
	Mains power supply (L1,L2,L3): three-phase 380V~440V, -15% ~+10%, 50Hz/60Hz
Circuit breaker	Please use a Type C MCB to protect the power cord and to cut the circuit in the event of overcurrent. The minimum current rating of the circuit breaker varies with the drive model.
Noise filter	Protection against external noise interference from the power cable, with the current rated at 10A or 20A.
Electromagnetic contactor	ON/OFF control of the input circuit.
External regenerative resistor	The minimum resistance value of the external regenerative resistor varies with the drive model.
Drive	DX3 Series Servo Drives.
Motor	Suitable for use with EM3A servo motors or EM3G (at rated power \geq 0.9kW) servo motors.
Controller	The device provided for servo applications, mechanical motion programming.
PC debugging tool	ESView V4 software for PC.
Cables	Encoder cables, motor power cables, external communication cables, IO cables, etc.

Specifications of the Basic Peripherals

Model	Main circuit voltage	Spec. of built-in regenerative resistor	Min. value of external regeneration resistor	Min. rated current of the circuit breaker
DX3-1A5AMA	Single-phase AC 200V~240V	–	45 Ω	4A(single-phase)
DX3-101AMA	Single-phase AC 200V~240V	–	45 Ω	4A(single-phase)
DX3-102AMA	Single-phase AC 200V~240V	–	45 Ω	4A(single-phase)
DX3-104AMA	Single-phase AC 200V~240V	–	45 Ω	4A(single-phase)
DX3-108AMA	Single-phase / 3-phase AC 200V~240V	50 Ω / 60W	25 Ω	10A(single-phase)/6A(3-phase)
DX3-110AMA	Single-phase / 3-phase AC 200V~240V	50 Ω / 60W	25 Ω	10A(single-phase)/6A(3-phase)

Model	Main circuit voltage	Spec. of built-in regenerative resistor	Min. value of external regeneration resistor	Min. rated current of the circuit breaker
DX3-115AMA	Single-phase / 3-phase AC 200V~240V	40Ω / 80W	25Ω	20A(single-phase) / 16A(3-phase)
DX3-120AMA	3-phase AC 200V~240V	40Ω / 80W	25Ω	16A(3-phase)
DX3-110DMA	3-phase AC 380V~440V	100Ω / 80W	65Ω	4A(3-phase)
DX3-115DMA	3-phase AC 380V~440V	100Ω / 80W	65Ω	6A(3-phase)
DX3-120DMA	3-phase AC 380V~440V	50Ω / 80W	40Ω	10A(3-phase)
DX3-130DMA	3-phase AC 380V~440V	50Ω / 80W	40Ω	16A(3-phase)
DX3-150DMA	3-phase AC 380V~440V	35Ω / 80W	20Ω	20A(3-phase)
DX3-175DMA	3-phase AC 380V~440V	35Ω / 80W	20Ω	25A(3-phase)

Drive model	power	Motor model	Encoder cable	Power cable
DX3-1A5A	50W	EM3A-A5A	EC3S-I1724-□□ (Incremental, IP65) EC3S-A1724-□□ (Absolute, IP65) EC3S-I1124-□□ (Incremental) EC3S-A1124-□□ (Absolute)	EC3P-N9118-□□ (No brakes) EC3P-B9118-□□ (With brake) EC3P-N9718-□□ (No brakes, IP65) EC3P-B9718-□□ (With brake, IP65)
DX3-101A	100W	EM3A-01A		
DX3-102A	200W	EM3A-02A		
DX3-104A	400W	EM3A-04A EM3J-04A		
DX3-108A	750W	EM3A-08A EM3J-08A	EC3P-N8118-□□ (No brakes) EC3P-B8118-□□ (With brake) EC3P-N8718-□□ (No brakes, IP65) EC3P-B8718-□□ (With brake, IP65)	
DX3-110A	1kW	EM3A-10A		
		EMG-10A	EC3S-I1324-□□ (Incremental) EC3S-A1324-□□ (Absolute)	
		EM3G-09A	EC3S-I1924-□□ (Incremental) EC3S-A1924-□□ (Absolute)	
DX3-115A	1.5kW	EMG-15A	EC3S-I1324-□□ (Incremental) EC3S-A1324-□□ (Absolute)	EC3P-N9314-□□ (No brakes) EC3P-B9314-□□ (With brake)
		EM3G-13A	EC3S-I1924-□□ (Incremental) EC3S-A1924-□□ (Absolute)	
		EM3A-15A	EC3S-I1924-□□ (Incremental) EC3S-A1924-□□ (Absolute)	
DX3-120A	2kW	EMG-20A	EC3S-I1324-□□ (Incremental) EC3S-A1324-□□ (Absolute)	
		EM3A-20A	EC3S-I1924-□□ (Incremental) EC3S-A1924-□□ (Absolute)	

Drive model	power	Motor model	Encoder cable	Power cable
DX3-110D	1kW	EM3G-09D□A224	EC3S-A1924-□□(Absolute)	EC3P-N9314-□□(No brakes) EC3P-B9314-□□(With brake)
DX3-115D	1.5kW	EM3A-15D□B224 EM3G-13D□A224	EC3S-A1924-□□(Absolute)	EC3P-N9314-□□(No brakes) EC3P-B9314-□□(With brake)
DX3-120D	2kW	EM3A-20D□B224 EM3G-18D□A224	EC3S-A1924-□□(Absolute)	EC3P-N9314-□□(No brakes) EC3P-B9314-□□(With brake)
DX3-130D	3kW	EM3A-30DLA224 EM3G-29DLA244	EC3S-A1924-□□(Absolute)	EC3P-N8313-□□(No brakes) EC3P-B8313-□□(With brake) EC3P-N8212-□□(No brakes) EC3P-B8212-□□(With brake)
DX3-150D	5kW	EM3A-40DLA224 EM3A-50DLA224 EM3G-44DLA224	EC3S-A1924-□□(Absolute)	EC3P-N9313-□□(No brakes) EC3P-B9313-□□(With brake) EC3P-N9319-□□(No brakes) EC3P-B9319-□□(With brake) EC3P-N9219-□□(No brakes) EC3P-B9219-□□(With brake)
DX3-175D	7.5kW	EM3G-55DLA224 EM3G-75DLA224	EC3S-A1924-□□(Absolute)	EC3P-N9219-□□(No brakes) EC3P-B9219-□□(With brake) EC3P-N9211-□□(No brakes) EC3P-B9211-□□(With brake)

□□: The last two digits of the cable indicate the length (as: 1M5、03、05、08、10、12、15、20), The unit is m.
Flexible cables are also provided, marked "-RX".

Chapter 2 Installation

2.1 Installation Precautions

- Installation Near Sources of Heat

Implement measures to prevent temperature increases caused by external heat sources so that the ambient temperature of the Drive is within the specified limits.

- Installation Near Sources of Vibration

Install a vibration absorber on the installation surface of the Drive so that the Drive will not be subjected to vibration.

- Other Precautions

Never install the Drive in a location subject to high temperatures, high humidity, water drops, cutting oil, excessive dust, excessive dirt, excessive iron powder, corrosive gasses, or radioactivity.

2.2 Mounting Types and Orientation

The Drives are based mounted and should be fitted to a non-painted metal surface. Mount the Drive vertically, as is shown in Figure 2-1.

Mount the Drives so that the Display Panel is facing toward the operator. Prepare two or three mounting holes for the Drive and mount it securely in the mounting holes (The number of mounting holes depends on the size of the Drive).

Figure 2-1 Base-mounted diagram

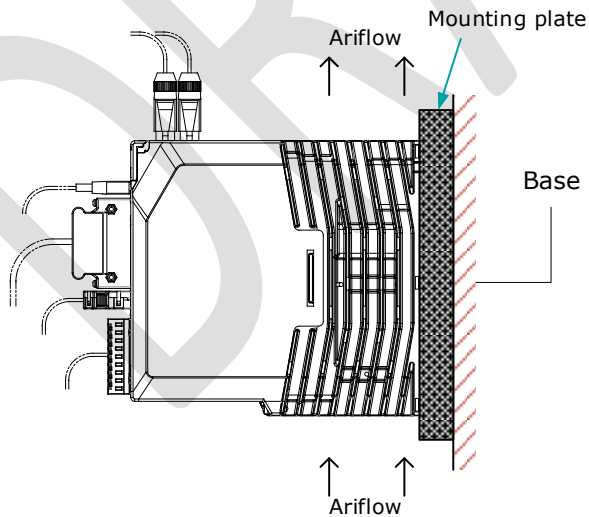

2.3 Mounting Hole Dimensions

Use all mounting holes to securely mount the Drive to the mounting surface.

To mount the Drive, use a screwdriver that is longer than the depth of the Drive.

Wiring diagram for mounting holes at 200VAC

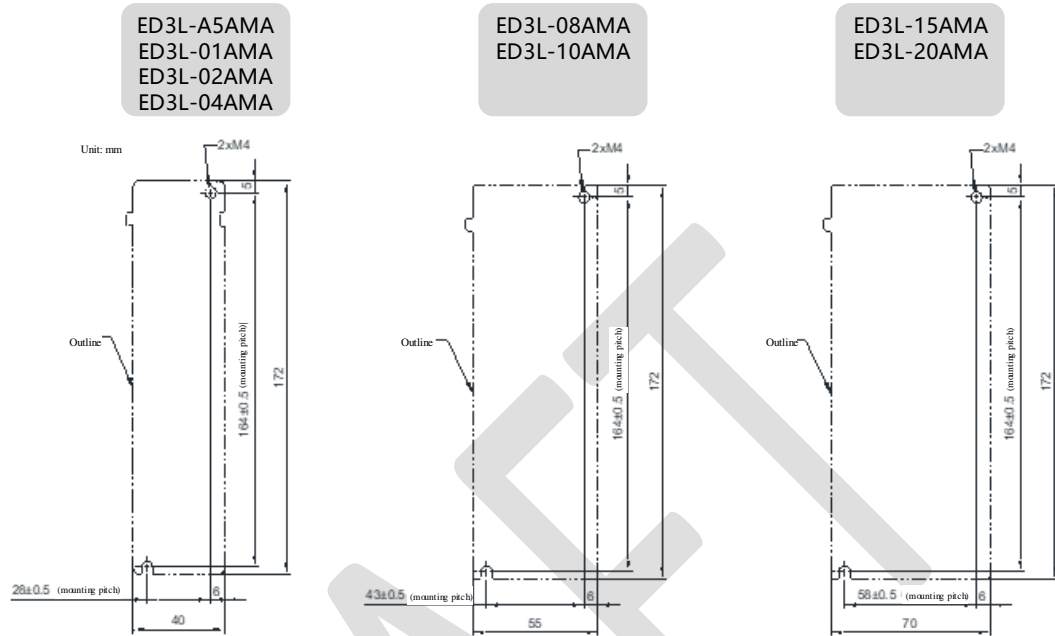

Wiring diagram for mounting holes at 400VAC

2.4 Mounting Interval

Installing One Drive in a Control Cabinet

When installing a single Drive use Figure 2-2 as a reference for free space around the installation.

Figure 2-2 Installing a single Drive in a control cabinet

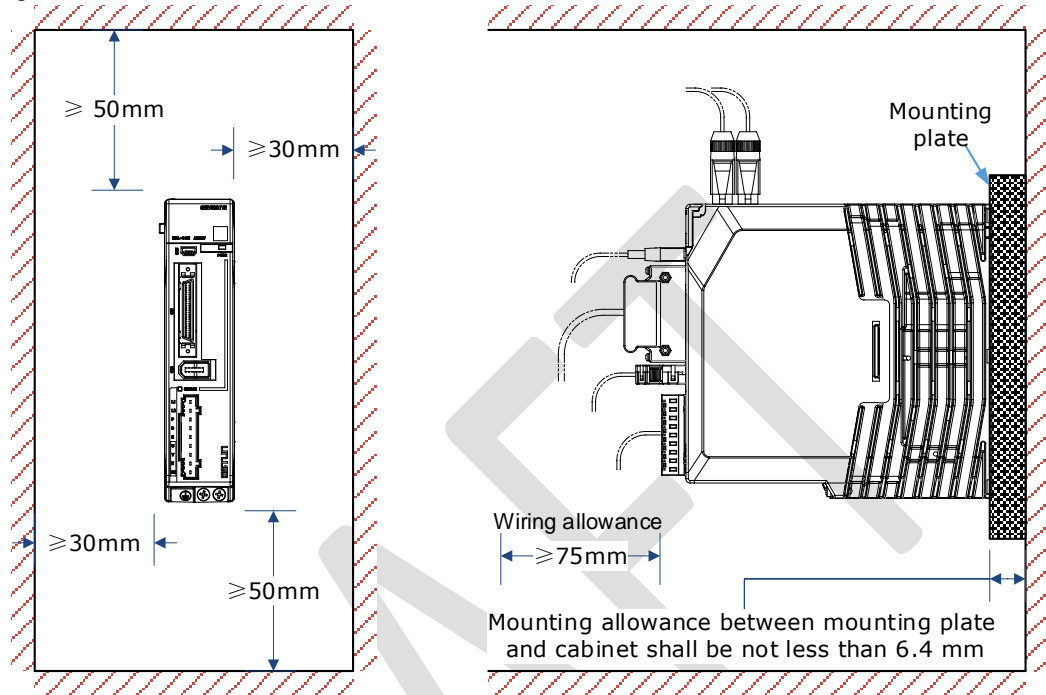

Installing multiple Drives in a Control Cabinet

When installing a multiple Drives use Figure 2-3 as a reference for free space around the installation.

Figure 2-3 Installing multiple Drives in a control cabinet

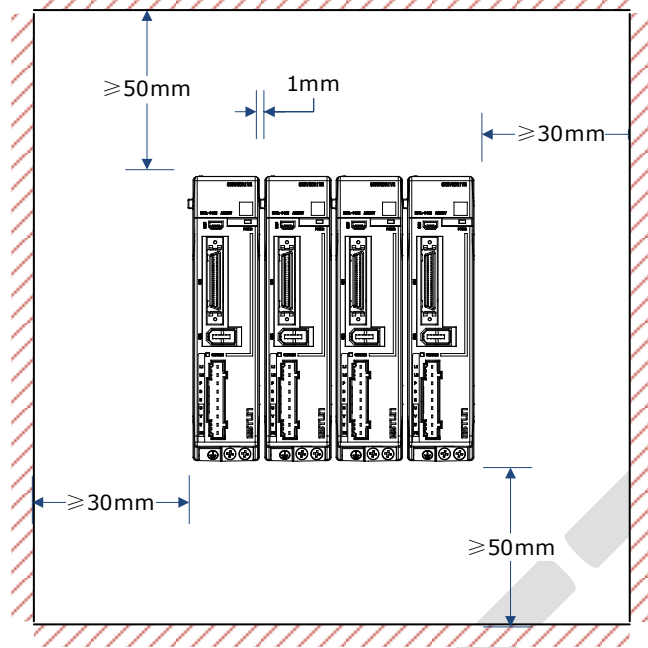

 NOTE

The DX3 allows close mounting with a distance of 1mm between two adjacent drives. The DX3 50D and 75D drives do not allow close mounting due to wiring, and the distance between drives is to be confirmed upon assembly of the cable, for which 80mm is the recommended

Chapter 3 Wiring and Connecting

3.1 Precautions for Wiring

3.1.1 General Precautions



Never change any wiring while power is being supplied, in case a risk of electric shock or injury.



- Wiring and inspections must be performed only by qualified engineers.
- Check all wiring and power supplies carefully. Incorrect wiring or incorrect voltage application to the output circuits may cause short-circuit failures. If a short-circuit failure occurs as a result of any of these causes, the holding brake will not work. This could damage the machine or cause an accident that may result in death or injury.
- Connect the AC and DC power supplies to the specified Drive terminals.



- Wait for at least five minutes after turning OFF the power supply and then make sure that the CHARGE indicator is not lit before starting wiring or inspection work. Never touch the power supply terminals while the CHARGE lamp is lit after turning OFF the power supply because high voltage may still remain in the Drive.
- Observe the precautions and instructions for wiring and trial operation precisely as described in this document.
- Check the wiring to be sure it has been performed correctly. Connectors and pin layouts are sometimes different for different models. Always confirm the pin layouts in technical documents for your model before operation.
- Use shielded twisted-pair cables or screened unshielded multi-twisted-pair cables for I/O Signal Cables and Encoder Cables.
- The main circuit cable of the Drive must be guaranteed to work normally at 75 °C.
- Observe the following precautions when wiring the Drive's main circuit terminals.
 - Turn ON the power supply to the Drive only after all wiring, including the main circuit terminals, has been completed.
 - If a connector is used for the main circuit terminals, remove the main circuit connector from the Drive before you wire it.
 - Insert only one wire per insertion hole in the main circuit terminals.
 - When you insert a wire, make sure that the conductor wire (e.g. whiskers) does not come into contact with adjacent wires.
- Install molded-case circuit breakers and other safety measures to provide protection against short circuits in external wiring.

**IMPORTANT**

- Use a molded-case circuit breaker or fuse to protect the main circuit. The Drive connects directly to a commercial power supply; it is not isolated through a transformer or other device. Always use a molded-case circuit breaker or fuse to protect the Servo System from accidents involving different power system voltages or other accidents.
- Install an earth leakage breaker. The Drive does not have a built-in ground fault protective circuit. To configure a safer system, install a ground fault detector against overloads and short-circuiting, or install a ground fault detector combined with a molded-case circuit breaker.
- Never turn the power supply ON and OFF more than necessary. Use the Drive for applications that require the power supply to turn ON and OFF frequently. Such applications will cause elements in the Drive to deteriorate.
- After you have started actual operation, allow at least one hour between turning the power supply ON and OFF (as a guideline).

3.1.2 Countermeasures against Noise

**IMPORTANT**

The Drive is designed as an industrial device. It therefore provides no measures to prevent radio interference. The Drive uses high-speed switching elements in the main circuit. Therefore, peripheral devices may be affected by switching noise.

If the equipment is to be used near private houses or if radio interference is a problem, take countermeasures against noise.

Since the Drive uses microprocessors, it may be affected by switching noise from peripheral devices.

To prevent the noise from the Drive or the peripheral devices from causing malfunctions of any devices, take the following countermeasures against noise as required.

- Install the input reference device and Noise Filter as close to the Drive as possible.
- Always install a Surge Absorber for relays, solenoids, and Magnetic Contactor coils.
- Never place the following cables in the same duct or bundle them together. Also, separate the cables from each other by at least 30 cm.
- Never share the power supply with an electric welder or electrical discharge machine. If the Drive is placed near a high-frequency generator, install Noise Filters on the input side on the Main Circuit Power Supply Cable and Control Power Supply Cable even if the same power supply is not shared with the high-frequency generator. Refer to the section **Noise Filters** for information on connecting Noise Filters.
- Implement suitable grounding measures. Refer to the section **Error! Reference source not found. Grounding** for information on grounding measures.

Noise Filters

You must attach Noise Filters in appropriate places to protect the Drive from the adverse effects of noise. 0 is an example of wiring for countermeasures against noise.

Wiring example for countermeasures against noise

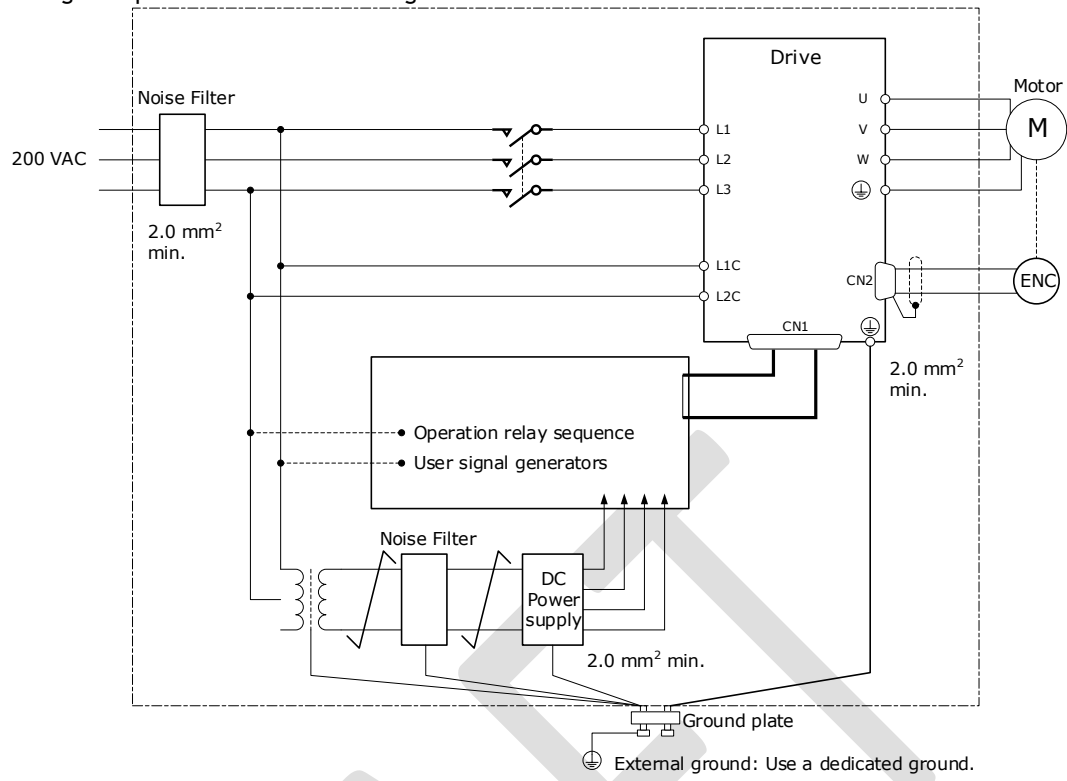

- For the ground wire, use a wire with a thickness of at least 2.0 mm² (preferably, flat braided copper wire).
- Whenever possible, use twisted-pair wires to wire all connections marked with $\overline{\text{L}}$

Noise Filter Wiring and Connection Precautions

Always observe the following precautions when wiring or connecting Noise Filters.

- Separate input lines from output lines. Do not place input lines and output lines in the same duct or bundle them together.

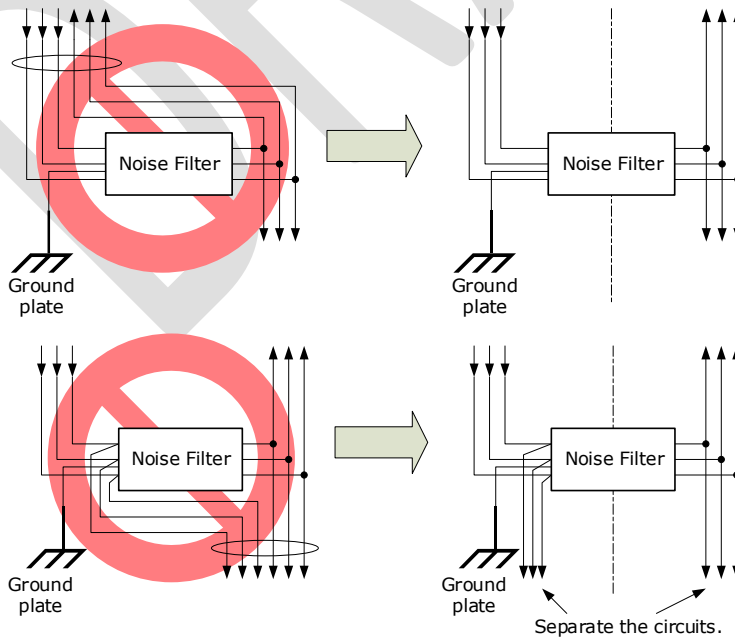

- Separate the Noise Filter ground wire from the output lines. Do not place the Noise Filter ground wire, output lines, and other signal lines in the same duct or bundle them together.

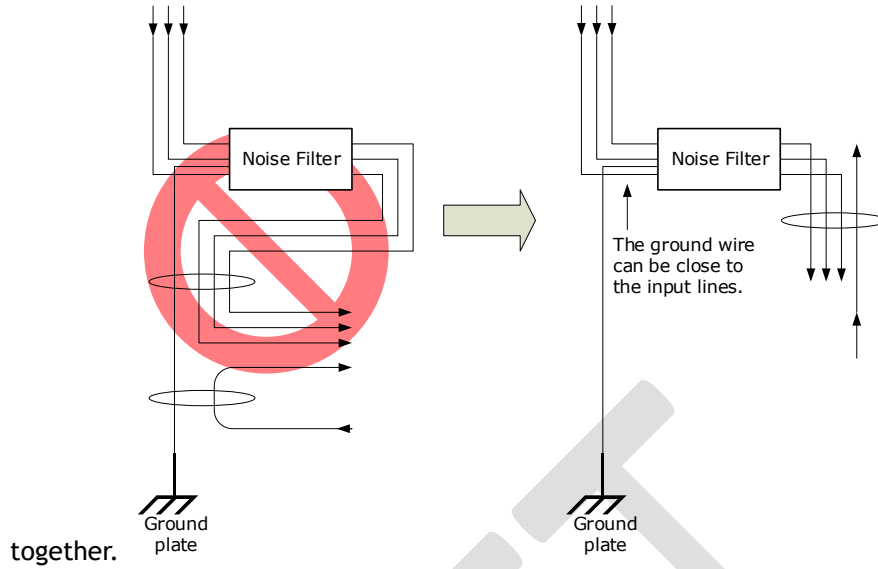

- Connect the Noise Filter ground wire directly to the grounding plate. Do not connect the Noise Filter ground wire to other ground wires.

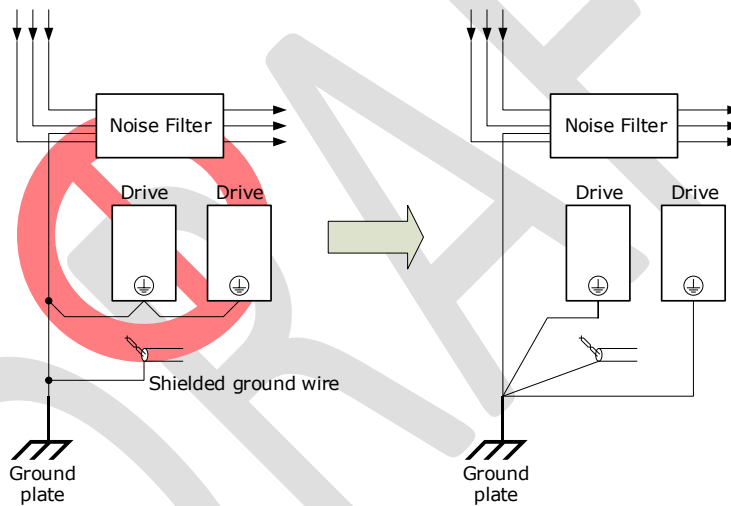

- If a Noise Filter is located inside a control panel, first connect the Noise Filter ground wire and the ground wires from other devices inside the control panel to the grounding plate for the control panel, then ground the plate.

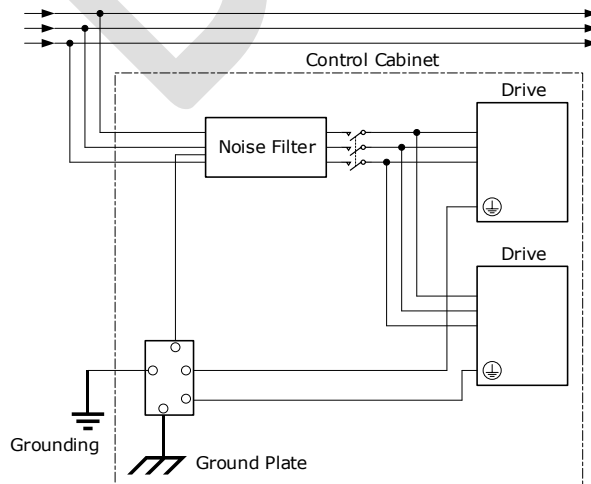

3.1.3 Recommended EMC Filters

To comply with the limits based on IEC/EN 61800-3 second environment (C2) the Drive and Motor must be installed with an EMC/RFI filter. Recommended filters are:

Drive voltage	DX3 Power Range	EMC C2
200VAC	50W to 1.5kW	Schaffner FN3270H-10-44
	2kW	Schaffner FN3270H-20-44
400VAC	1kW-2 kW	Schaffner FN 3025HP-10-71
	3kW-5 kW	Schaffner FN 3025HP-10-71
	7.5kW	Shanghai Aerodev DNF51-3PH-3 × 20A

NOTE

These filters have been tested with cable lengths of 3m and 20m.

3.1.4 Grounding

Implement grounding measures as described in this section. Implementing suitable grounding measures will also help prevent malfunctions, which can be caused by noise. Always use an unpainted backplane for electrical cabinets.

- Ground the Drive to a resistance of 100 mΩ or less.
- Be sure to ground at one point only.

Ground the Motor directly if the Motor is insulated from the machine.

Motor Frame Ground or Motor Ground

If the Motor is grounded through the machine, the switching noise current can flow from the main circuit of the Drive through the stray capacitance of the Motor. To prevent this always connect the Motor frame terminal (FG) or ground terminal (FG) of the Motor to the ground terminal \oplus on the Drive. Also, be sure to ground the ground terminal \oplus .

Noise on I/O Signal Cables

To prevent noise entering the I/O Signal Cable connect the shield of the I/O Signal Cable to the connector shell and ensure the shell is connected to ground.

If placing cables in metal conduits, ensure the conduit is connected to ground.

For all grounding, use a single grounding point.

Cable Fixing

It is recommended that all cable shields are secured with a conductive metal clamp to the ground plate.

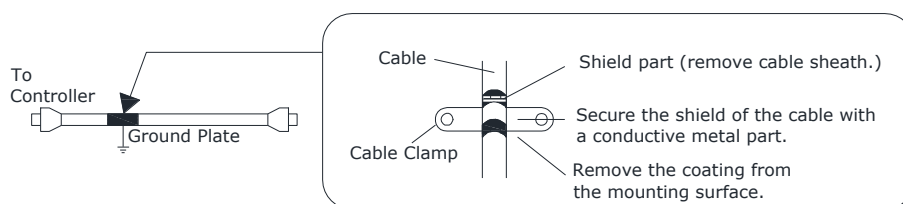

Ferrite Coils

While ferrite coils can be used to solve application specific EMC issues, they should not be necessary for applications.

DRAFT

3.2 Basic Wiring Diagrams

Rated power from 50W to 400W

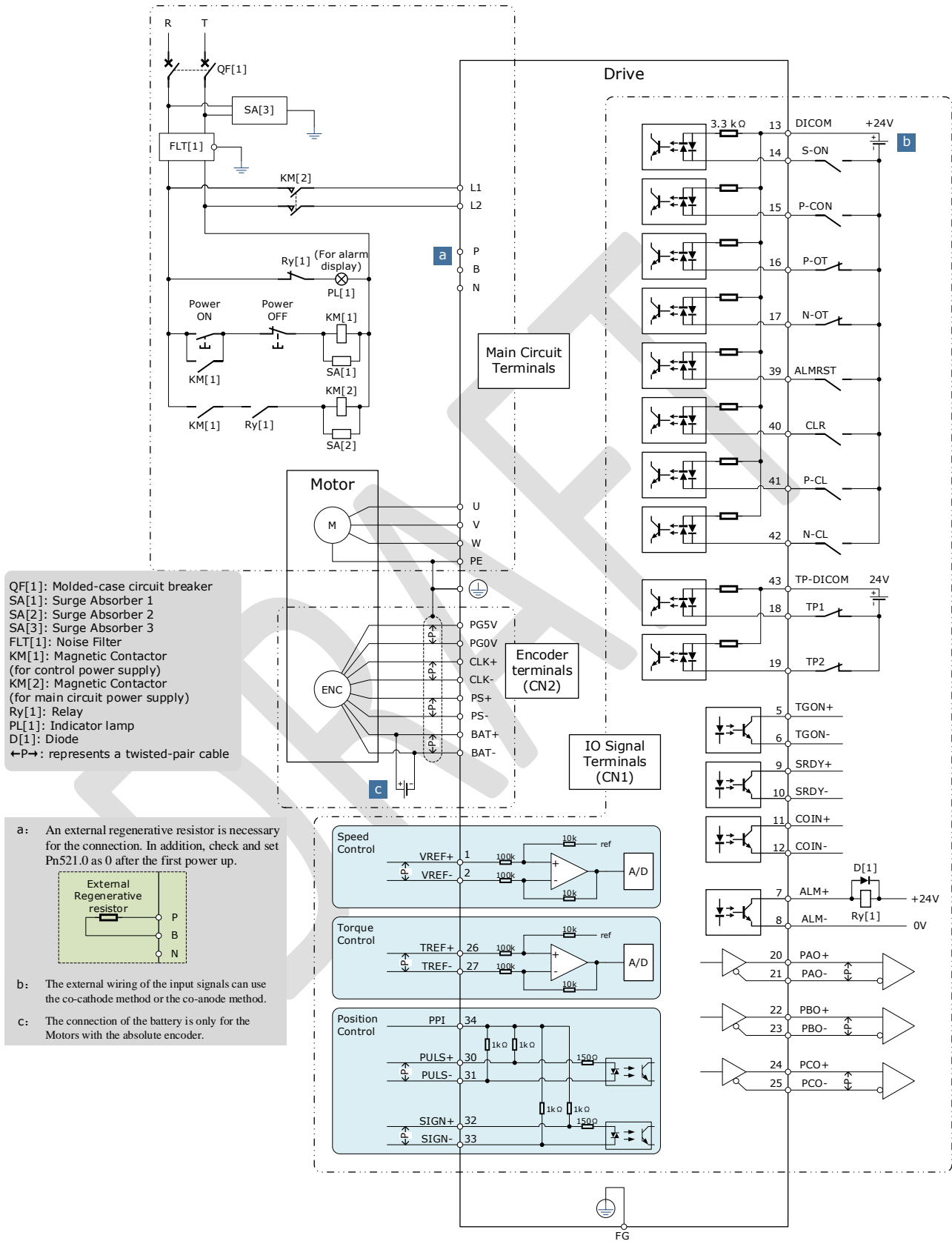

Rated power from 750W to 2kW

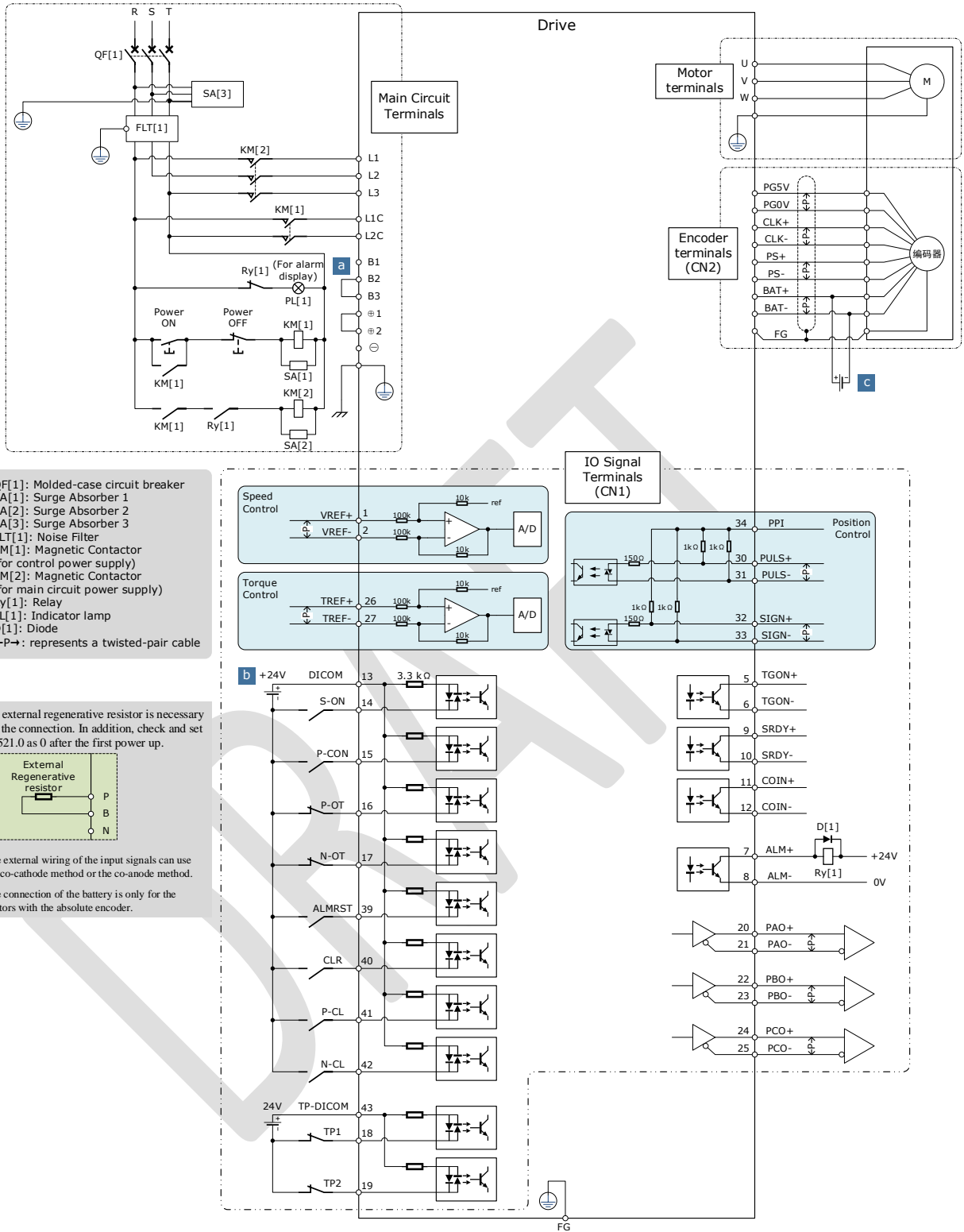

400VAC, rated power from 1kW to 7.5kW

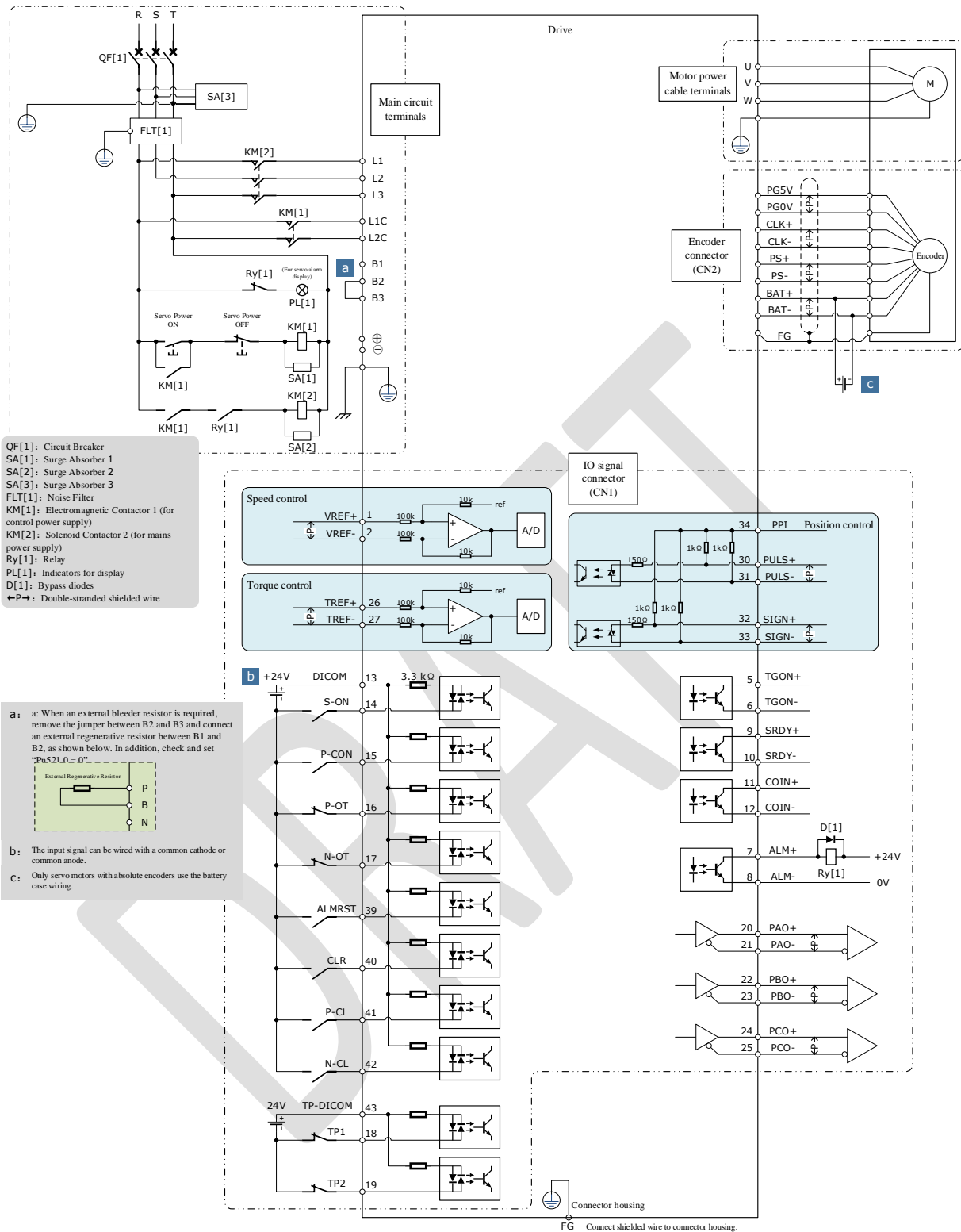

3.3 Terminals Arrangements

Rated power from 50W to 400W

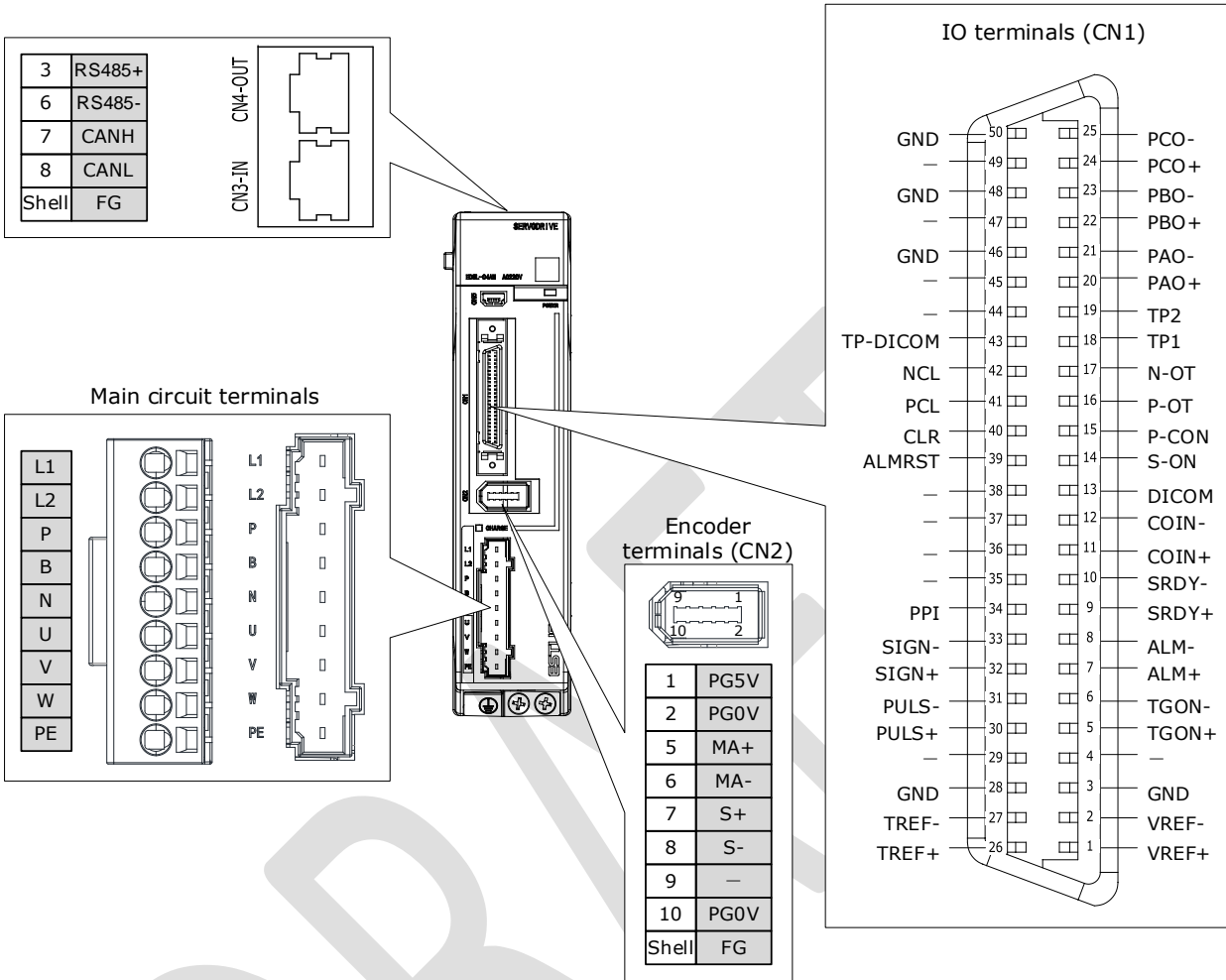

200VAC, rated power from 750W to 2kW

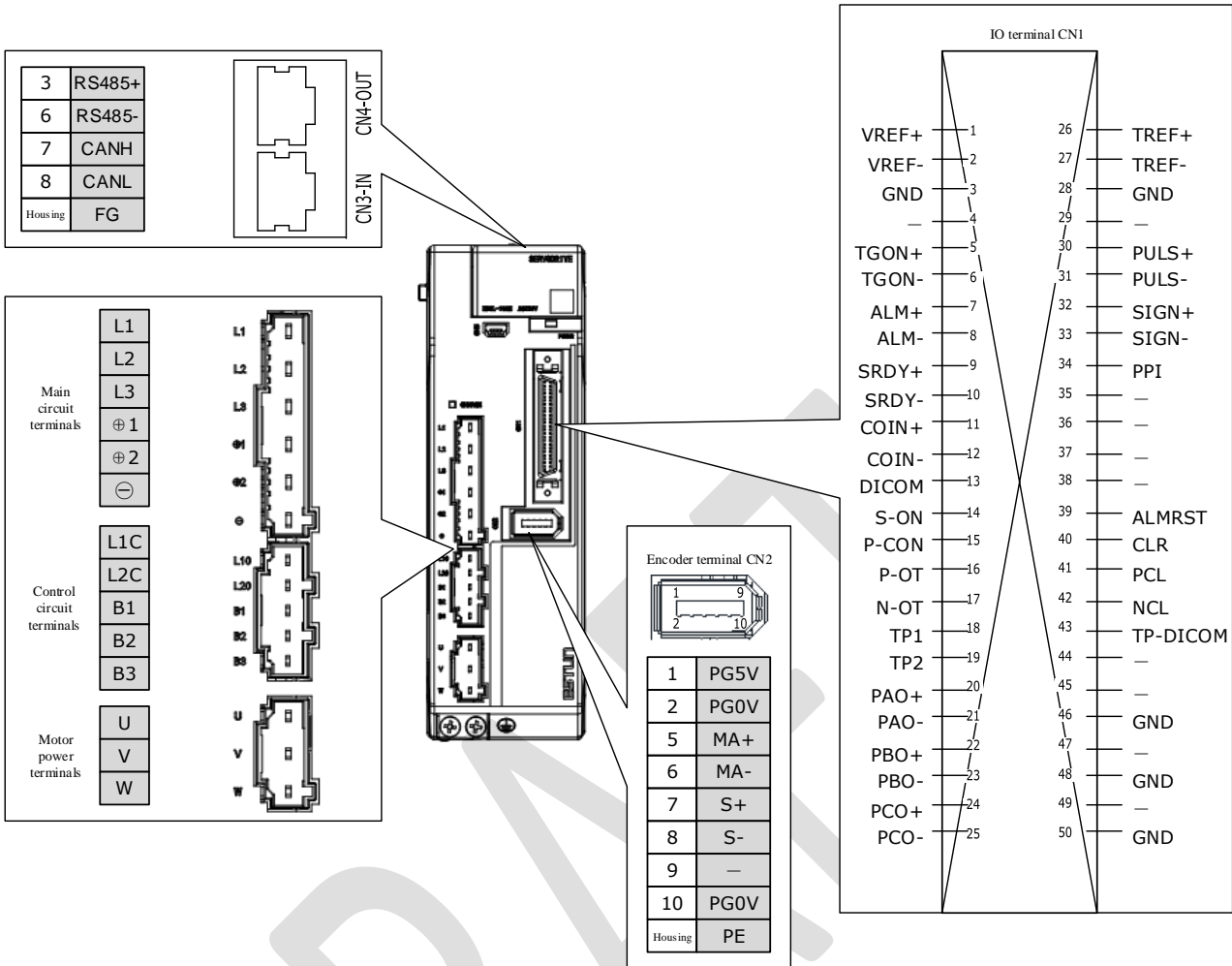

400VAC, rated power from 1kW to 1.5kW

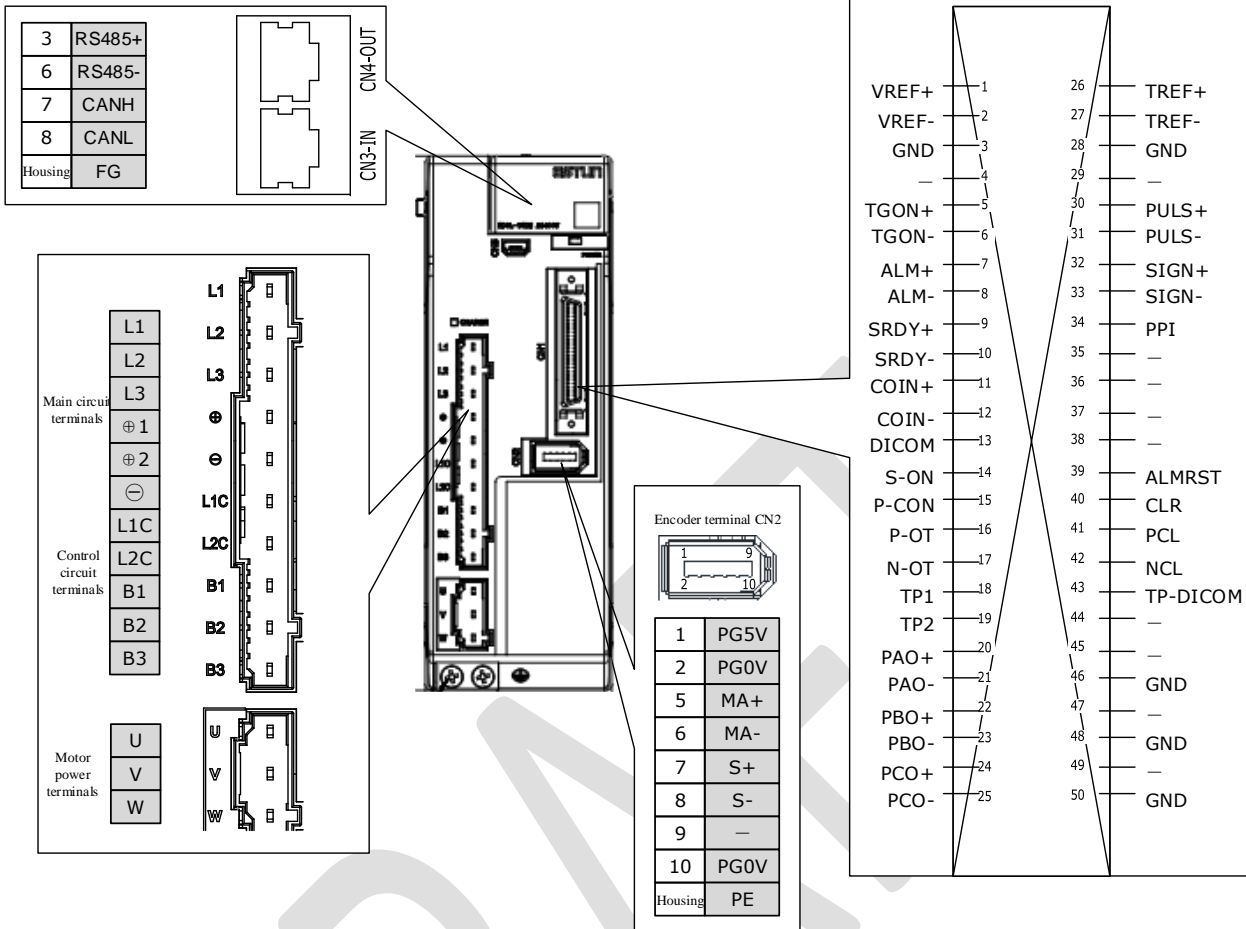

400VAC , rated power from 2kW to 3kW

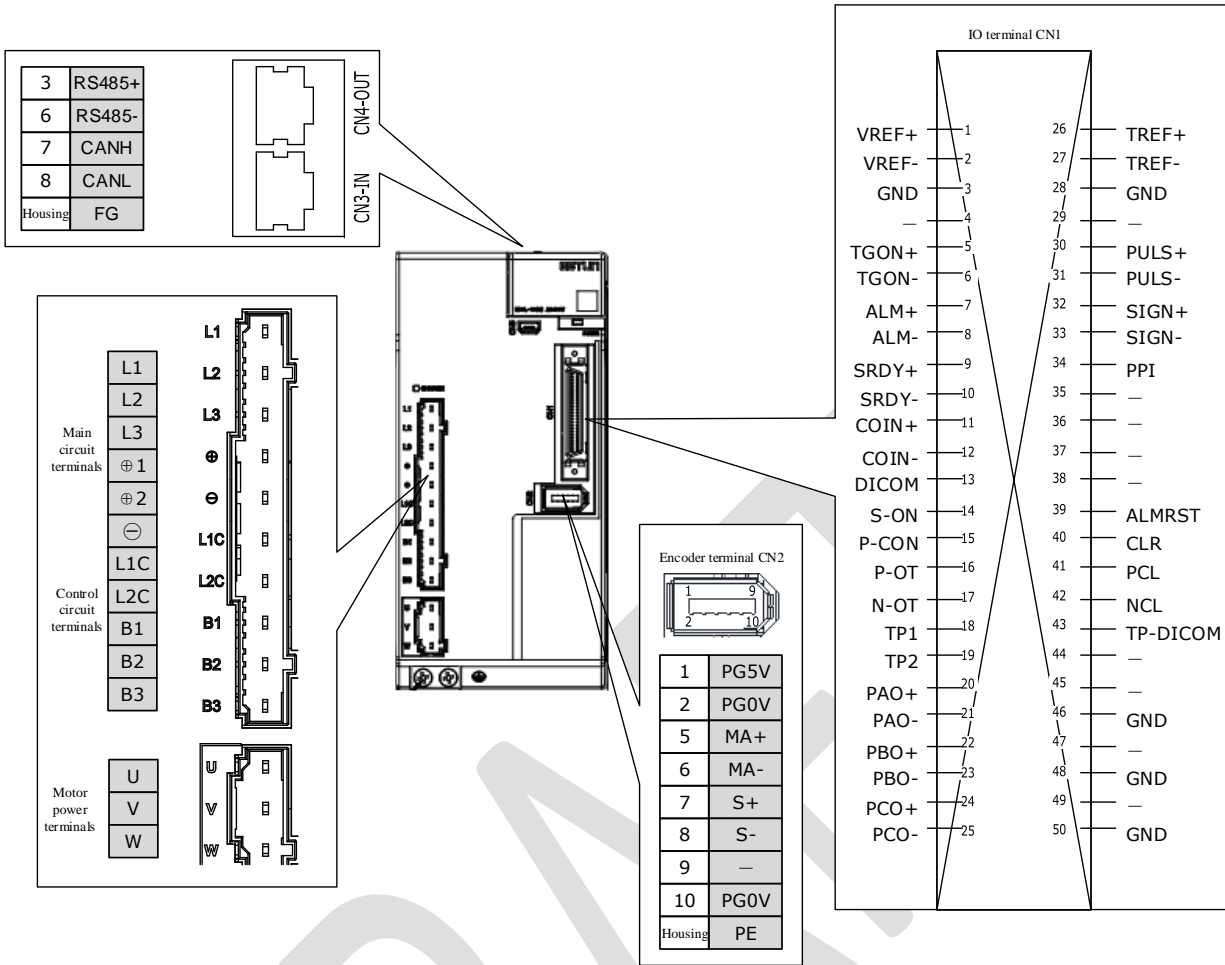

400VAC, rated power from 5kW to 7.5kW

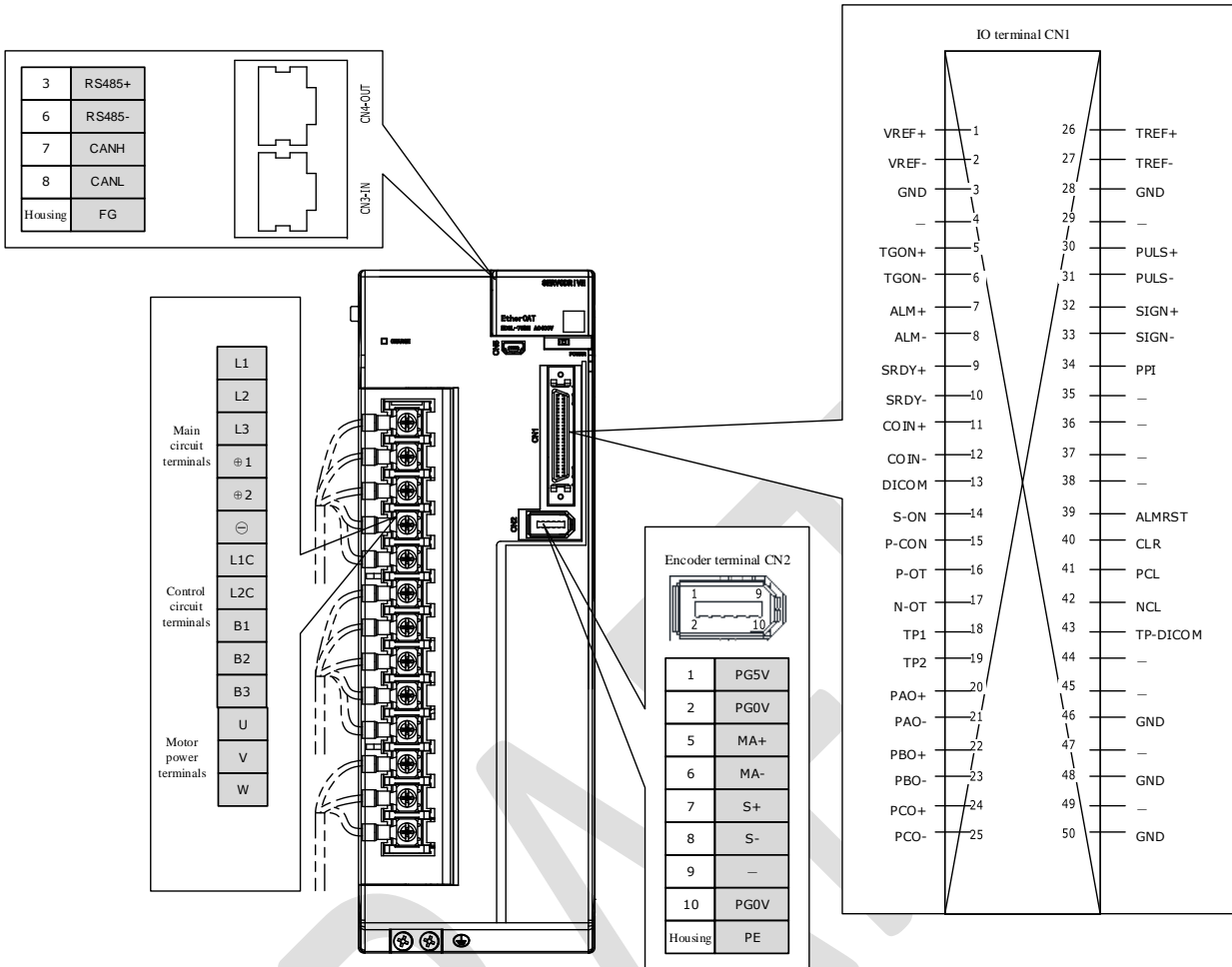

3.4 Wiring the Power Supply to Drive

3.4.1 Terminals Arrangement

Rated power from 50W to 400W

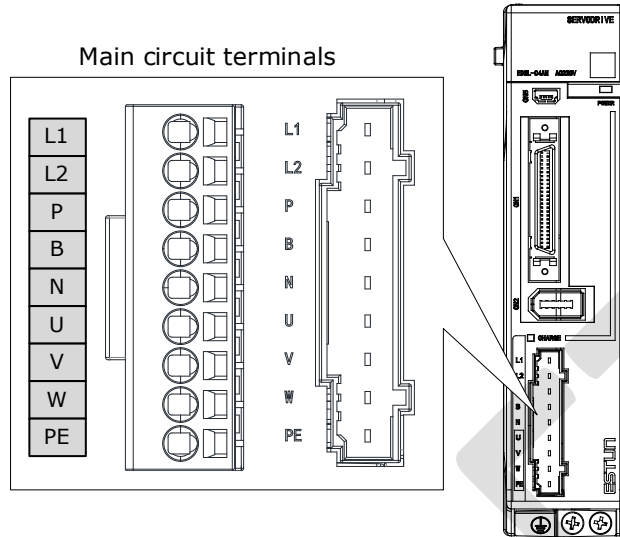

Symbols	Name	Specifications and Reference
L1、L2	Main circuit power supply input terminals	Single-phase, 200 VAC to 240 VAC, -15% to +10%, 50Hz or 60Hz
P、B	Regenerative Resistor terminal	Connects a regenerative resistor with a minimum resistance value of 45 ohm
P、N	DC terminals	For the common DC bus, connect all P of Drive to the positive pole, and N to the negative pole.
U、V、W	Motor terminals	Connects the U-phase, V-phase and W-phase of Motor
PE	Ground terminal	Always connect this terminal to prevent electric shock.

Rated power from 750W to 2kW

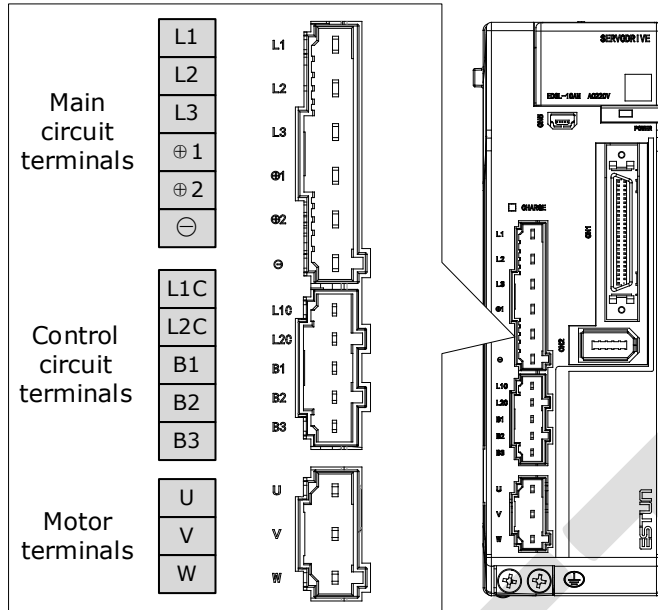

Symbols	Name	Specifications and Reference
L1、L2、L3	Main circuit power supply input terminals	Three-phase, 200 VAC to 240 VAC, -15% to +10%, 50Hz or 60Hz
⊕1、⊕2	DC reactor terminals	For using a DC reactor, remove the short wiring, and connect a DC reactor between ⊕1 and ⊕2.
⊕2、⊖	DC terminals	For the common DC bus, connect all ⊕2 of Drive to the positive pole, and ⊖ to the negative pole.
L1C、L2C	Control circuit terminals	Single-phase, 200 VAC to 240 VAC, -15% to +10%, 50Hz or 60Hz
B1、B2、B3	Regenerative Resistor terminal	There is a short wiring between B2 and B3 at the factory. <ul style="list-style-type: none"> When the busbar capacitance is insufficient, remove the short wiring, and connect an external regenerative resistor between B1 and B2.
U、V、W	Motor terminals	Connects the U-phase, V-phase and W-phase of Motor
⊕	Ground terminal	Always connect this terminal to prevent electric shock.

400VAC, rated power from 1kW to 3kW

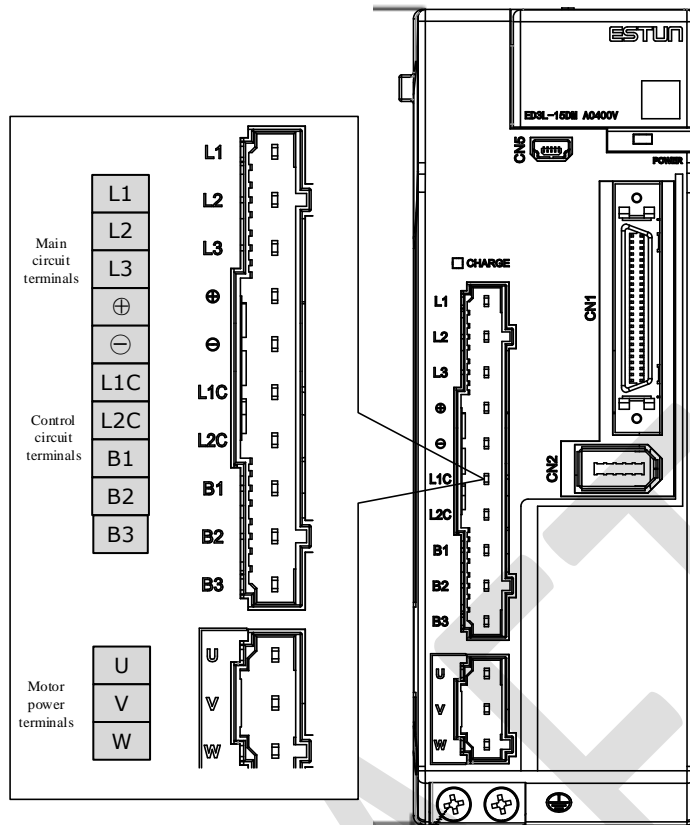

Take for example a product with a power rating of 1kW~1.5kW. Products with power rating from 1.5kW to 3kW are similar in appearance and have the same components

Symbol	Name	Specifications
L1, L2, L3	Power supply input terminals	3-phase AC 380V~440V, -15%~+10%, 50Hz/60Hz
⊕	DC reactor connectors	Prior to delivery, the connection between ⊕1 and ⊕2 is in a shorted state. When using a DC reactor, a DC reactor is connected between ⊕1 and ⊕2.
⊖	DC busbar connectors	When multiple servo drives are used in a common DC bus configuration, ⊕2 and ⊖ of all drives are connected in series, respectively.
L1C, L2C	Control power terminals	Single phase AC 200V-240V, -15%~ +10%, 50Hz/60Hz
B1, B2, B3	Regenerative resistor connectors	<ul style="list-style-type: none"> When using the built-in regenerative resistor: Keep the connection between B2 and B3 shorted. When using an external regenerative resistor: Please remove the jumper between B2 and B3 and connect the external regenerative resistor between B1 and B2.
U, V, W	Motor power connectors	Connect the U, V and W phases of the motor.

Symbol	Name	Specifications
⊖	Grounding terminals	Connect the power supply earth terminal for earthing.

400VAC, rated power from 5kW to 7.5kW

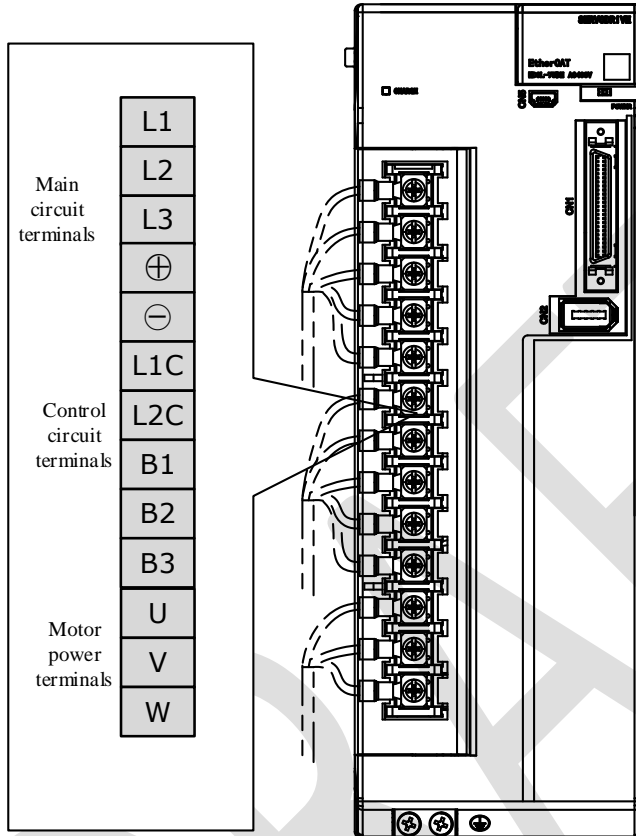

Symbols	Name	Specifications
L1, L2, L3	Power supply input terminals	3-phase 380V~440V, -15%~+10%, 50Hz/60Hz
⊖	DC busbar connectors	When multiple servo drives are used in a common DC bus configuration, ⊕ and ⊖ of all drives are connected in series, respectively.
L1C, L2C	Control power terminals	Single phase AC 380V~440V, -15%~ +10%, 50Hz/60Hz
B1, B2, B3	Regenerative resistor connectors	<ul style="list-style-type: none"> • When using the built-in regenerative resistor: Keep the connection between B2 and B3 shorted. • When using an external regenerative resistor: Please remove the jumper between B2 and B3 and connect the external regenerative resistor between B1 and B2.
U, V, W	Motor power connectors	Connect the U, V and W phases of the motor.

Symbols	Name	Specifications
⊕	Grounding terminals	Connect the power supply earth terminal for earthing.
L1, L2, L3	Power supply input terminals	3-phase 380V~440V, -15%~+10%, 50Hz/60Hz

DRAFT

3.4.2 Wiring a Regenerative Resistor

Diver model	Rted power	minimum value	Connection terminals
DX3-1A5A	50W	45Ω	P、B
DX3-101A	100W		
DX3-102A	200W		
DX3-104A	400W		
DX3-108A	750W	25Ω	B1、B2
DX3-110A	1kW	10Ω	B1、B2C
DX3-115A	1.5kW		
DX3-120A	2kW	65Ω	B1、B2
DX3-110DEA	1kW		
DX3-115DEA	1.5kW	40Ω	B1、B2
DX3-120DEA	2.0kW		
DX3-130DEA	3.0kW	20Ω	B1、B2
DX3-150DEA	5.0kW		
DX3-175DEA	7.5kW		

Figure 3-1 is an example of connecting an external regenerative resistor for the drives rated power from 50W to 400W.

Figure 3-1 Wires a regenerative resistor

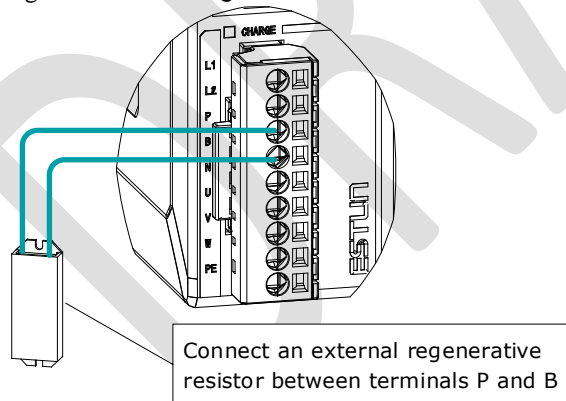



Connect the external regenerative resistor as following to avoid damaging the drive or malfunction.

- It is necessary to connect an external regenerative resistor for the drives rated power from 50W to 400W. The minimum resistance value of the external regenerative resistor is 45 ohms.
Never connect the external regenerative resistor between terminals P and N.
 - In the case of the drives rated power from 750W to 1kW, confirms whether the bus capacitance is insufficient. If necessary, connect an external regeneration resistor between terminals B1 and B2. The minimum resistance value of the external regenerative resistor is 25 ohms.
Never connect the external regenerative resistor between terminals B1 and B3.
 - When an external regenerative resistor is connected, check and set Pn521.0 as 0 after the power up.
 - Please check and confirm that the external regenerative resistor is mounted on non-combustible materials.
-

DRAFT

3.4.3 Wiring Procedure

Prepare the following items before preparing the wiring for the Main Circuit Terminals and Control Circuit Terminals.

Required Item	Description
Flat-blade screwdriver or Terminal removal tool	<ul style="list-style-type: none"> Flat-blade screwdriver: commercially available screwdriver with tip width of 3.0 mm to 3.5 mm Terminal removal tool: an accessory of the Drive
Cold pressed terminals	Sleeve type ferrule with cross-section from 1.5 mm ² to 2.5 mm ²
Wiring plier	Commercially available plier with crimping and stripping functions

Follow the procedure below to wire the Main Circuit Terminals and Control Circuit Terminals.

Step 1 Remove the Main Circuit Terminals and Control Circuit Terminals from the Drive.

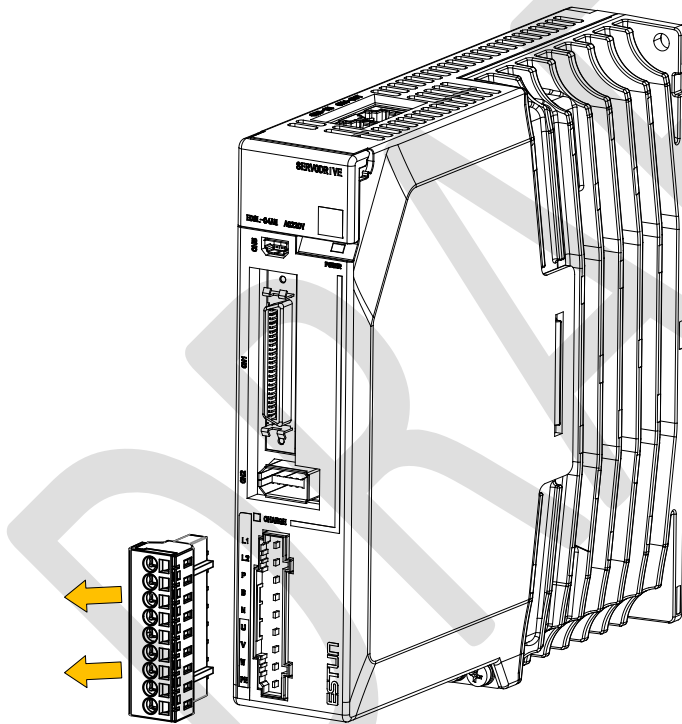

Step 2 Peel off the sheath so that the conductor portion of the cable will protrude from the tip of the ferrule.

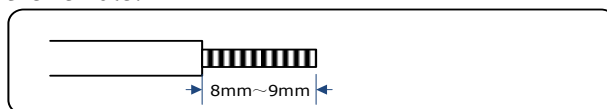

Step 3 Insert the cable into the ferrule (It should protrude 1 mm or more from the ferrule).

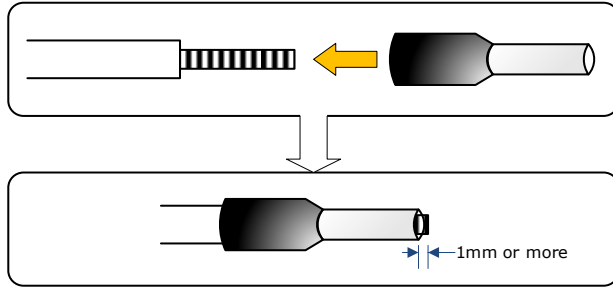

Step 4 Crimp the cable that has been inserted into the ferrule, and cut off the cable conductor portion protruding from the ferrule (The allowable protruding length after cutting should not be more than 0.5 mm).

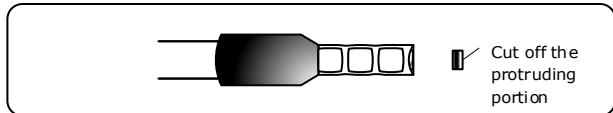

Step 5 Use the flat-blade screwdriver or the terminal removal tool to press down the spring button corresponding to the terminal, and then insert the cable.

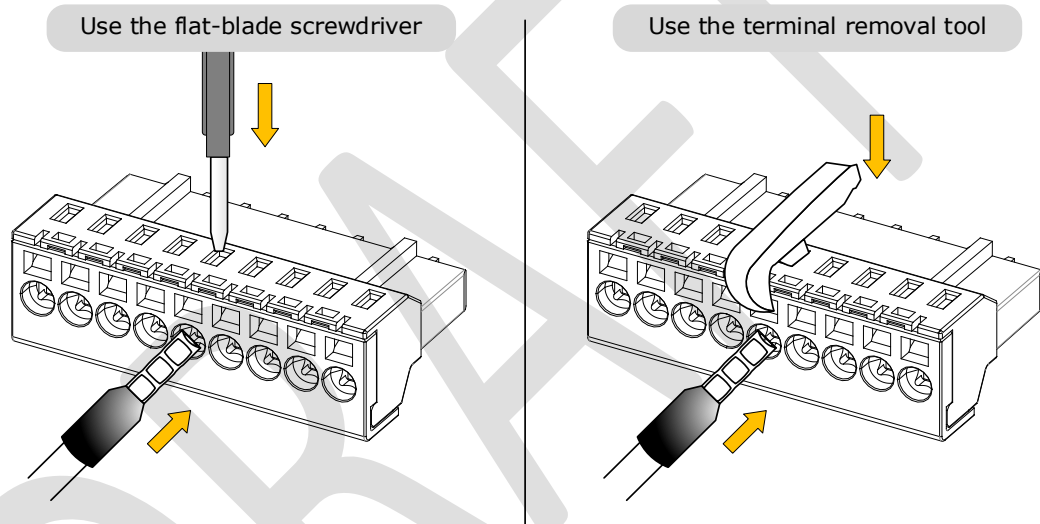

Step 6 Insert the crimped cable into the connection terminals, and then pull out the tool.

Step 7 Make all other connections in the same way.

Step 8 To change the wiring, pull the cable out of the connection terminals.
Use the flat-blade screwdriver to press down the spring button corresponding to the terminal, and then gently pull out the cable.

Step 9 When you have completed wiring, attach connection terminals to the Drive.

 NOTE

The above wiring procedure is also applicable to the Motor Terminals.

----End

3.4.4 Motor Connection Diagram

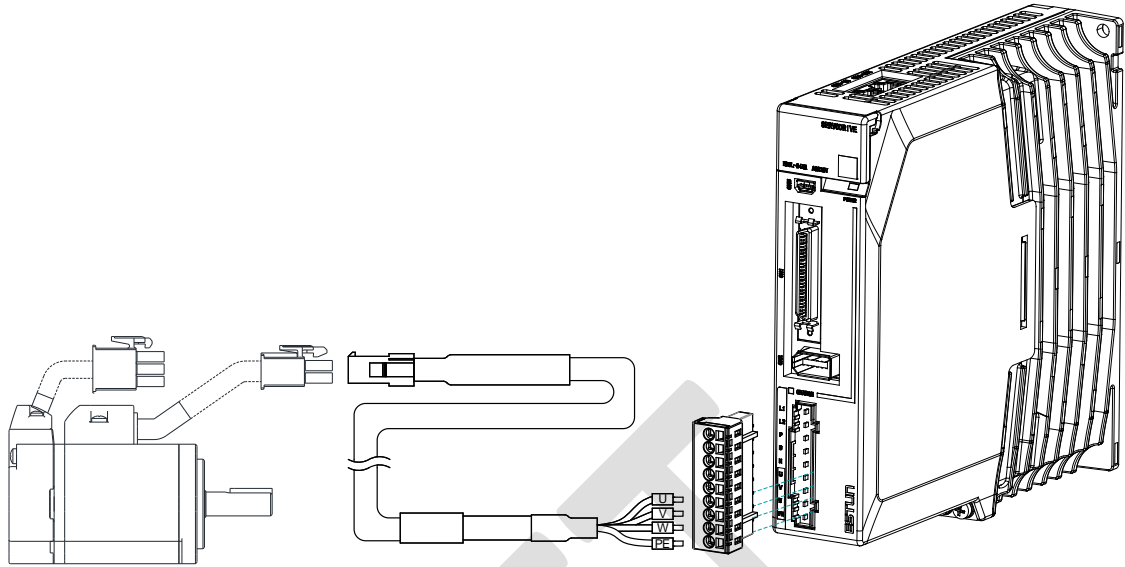

3.4.5 Motor Power Cable Description

The Motor power cable depends on the Motor model. The common models are shown in the table below.

Motor model	Brake	IP65 Plug	Wire diameter	Motor power cable		
				length is 3.0m	length is 5.0m	length is 10.0m
EM3A-A5A EM3A-01A	No	No	2.0mm ²	EC3P-N9118-03	EC3P-N9118-05	EC3P-N9118-10
EM3A-02A EM3A-04A	No	Yes		EC3P-B9118-03	EC3P-B9118-05	EC3P-B9118-10
EM3A-08A EM3A-10A	Yes	No		EC3P-N9718-03	EC3P-N9718-05	EC3P-N9718-10
EM3J-04A EM3J-08A	Yes	Yes		EC3P-B9718-03	EC3P-B9718-05	EC3P-B9718-10
EM3A-15A EM3A-20A	Not provided	Yes		EC3P-N9314-03	EC3P-N9314-05	EC3P-N9314-10
EM3A-15D EM3A-20D	Provided	Yes		EC3P-B9314-03	EC3P-B9314-05	EC3P-B9314-10
EM3A-30D	Not provided	Yes		EC3P-N8718-03	EC3P-N8718-05	EC3P-N8718-10
EM3G-09A EM3G-13A						
EMG-10A EMG-15A EMG-20A	Provided	Yes		EC3P-B8718-03	EC3P-B8718-05	EC3P-B8718-10
EM3A-30D	Not provided	Yes		EC3P-N8214-03	EC3P-N8214-05	EC3P-N8214-10
	Provided	Yes	EC3P-B8214-03			
EM3A-40D	Not provided	Yes	3.5mm ²	EC3P-N9319-03	EC3P-N9319-05	EC3P-N9319-10
	Provided	Yes				
EM3A-50D	Not provided	Yes		EC3P-N9319-03	EC3P-N9319-05	EC3P-N9319-10

Motor model	Brake	IP65 Plug	Wire diameter	Motor power cable			
				length is 3.0m	length is 5.0m	length is 10.0m	
	Provided	Yes		EC3P-B9319-03	EC3P-B9319-05	EC3P-B9319-10	
EM3G-29D	Not provided	Yes	4.0mm ²	EC3P-N8212-03	EC3P-N8212-05	EC3P-N8212-10	
	Provided	Yes		EC3P-N8212-03	EC3P-N8212-05	EC3P-N8212-10	
EM3G-44D	Not provided	Yes		EC3P-N9212-03	EC3P-N9212-05	EC3P-N9212-10	
	Provided	Yes		EC3P-B9212-03	EC3P-B9212-05	EC3P-B9212-10	
EM3G-55D	Not provided	Yes		EC3P-N9212-03	EC3P-N9212-05	EC3P-N9212-10	
	Provided	Yes		EC3P-B9212-03	EC3P-B9212-05	EC3P-B9212-10	
EM3G-75D	Not provided	Yes		5.0mm ²	EC3P-N9211-03	EC3P-N9211-05	EC3P-N9211-10
	Provided	Yes			EC3P-B9211-03	EC3P-B9211-05	EC3P-B9211-10

The following shows the diagram and wiring description of each Motor power cable.

Cable Model	Brake	IP65
EC3P-N9118-□□	Not provided	No

Motor side
Drive side

Pin No.	Signal	Color
1	U	Brown
2	V	Grey
3	W	Black
4	FG	Yellow/green

Pin No.	Signal	Color
1	U	Brown
2	V	Grey
3	W	Black
4	FG	Yellow/green

Recommended wire diameter for U, V, W and FG:1mm²

Cable Model	Brake	IP65
EC3P-B9118-□□	Provided	No

Motor side
Drive side

Pin No.	Signal	Color
1	U	Brown
2	V	Grey
3	W	Black
4	FG	Yellow/green
5	B1	White
6	B2	Green

Pin No.	Signal	Color
1	U	Brown
2	V	Grey
3	W	Black
4	FG	Yellow/green
5	B1	White
6	B2	Green

Recommended wire diameter for U, V, W and FG:1mm²

Recommended wire diameter for B1 and B2: 0.5mm²

Cable Model	Brake	IP65
EC3P-N9718-□□	Not provided	Yes

Motor side
Drive side

Pin No.	Signal	Color
1	U	Brown
2	V	Grey
3	W	Black
4	FG	Yellow/green

Pin No.	Signal	Color
1	U	Brown
2	V	Grey
3	W	Black
4	FG	Yellow/green

Recommended wire diameter for U, V, W and FG:1mm²

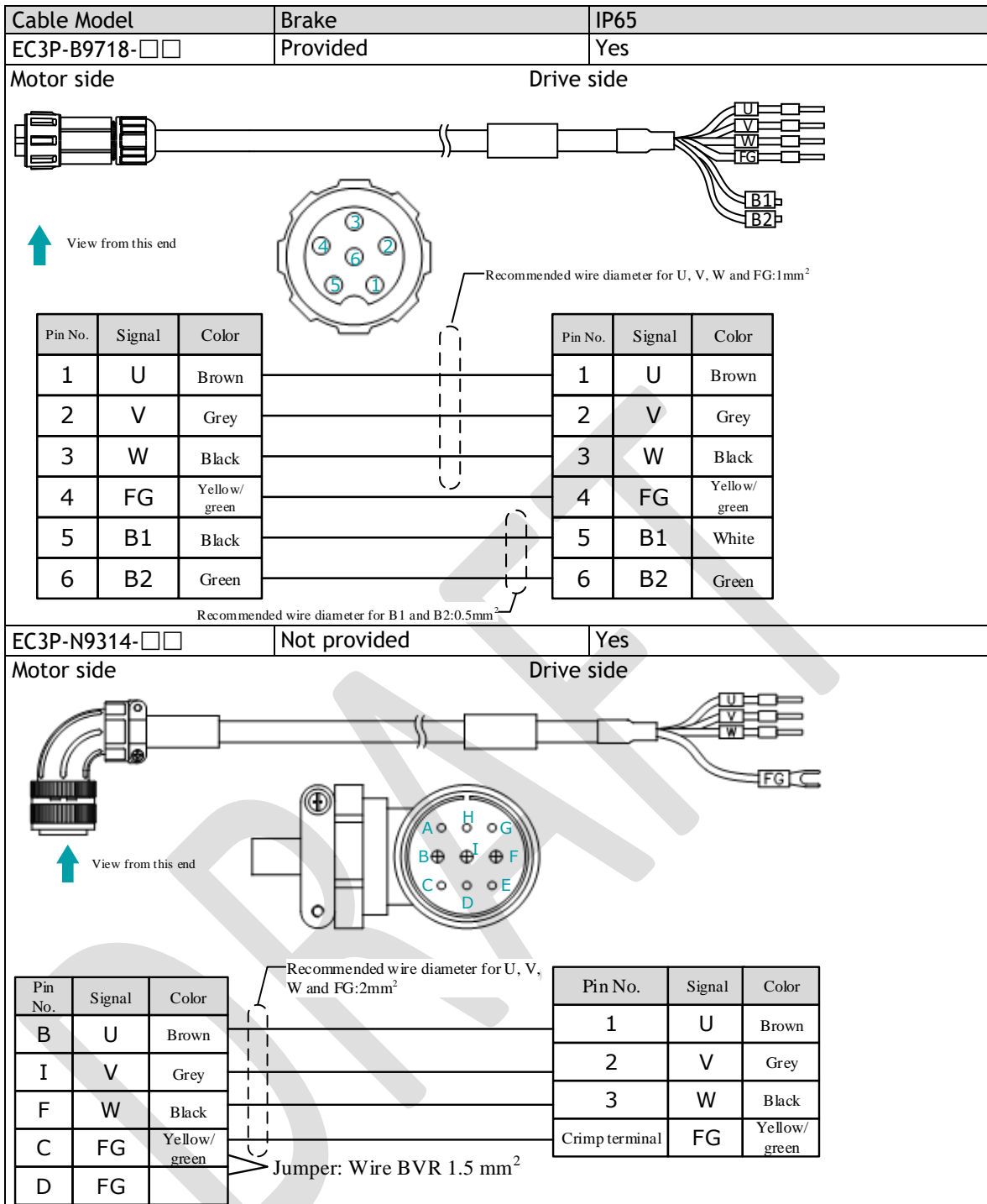

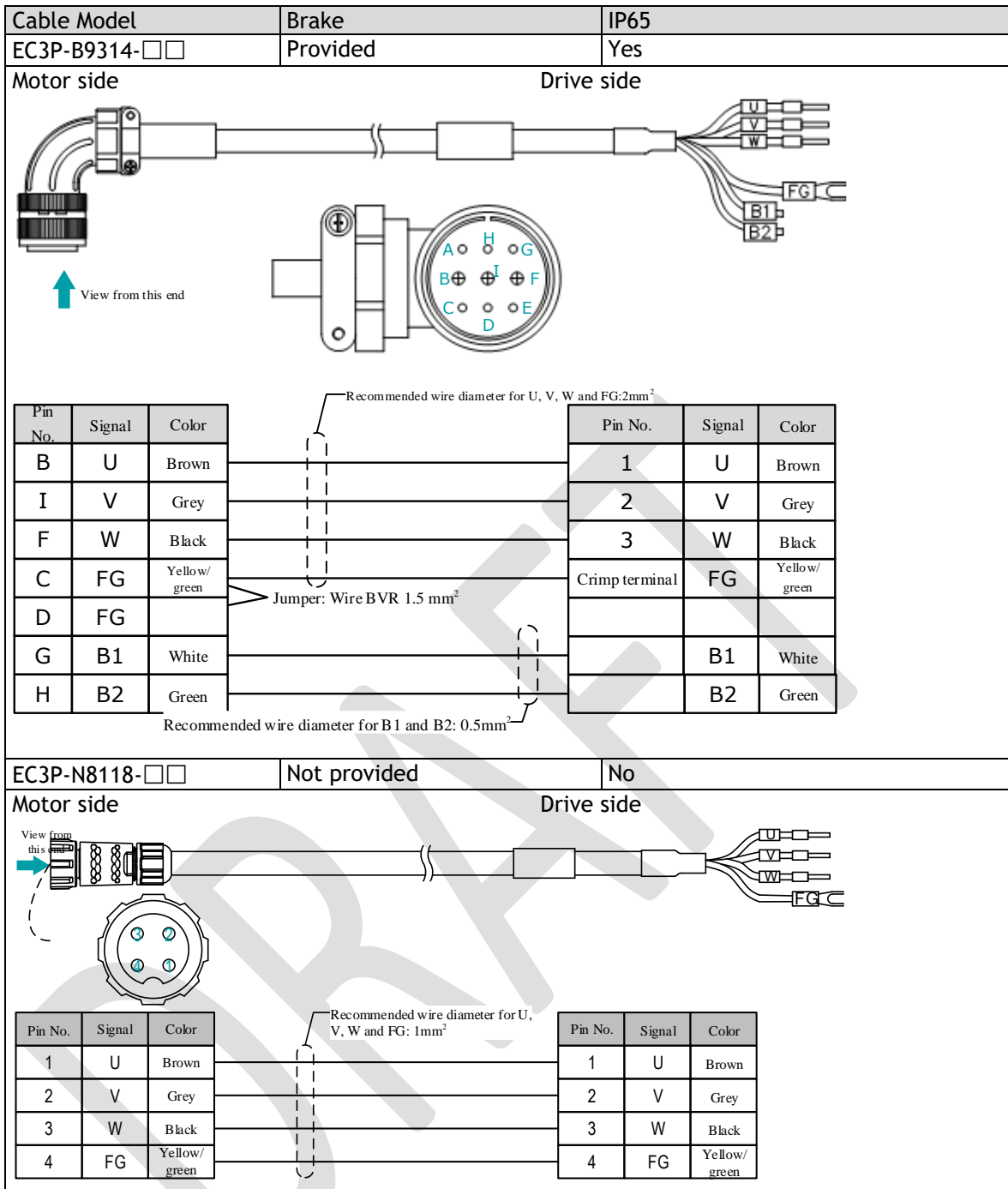

Motor side
Drive side

Pin No.	Signal	Color
1	U	Brown
2	V	Grey
3	W	Black
4	FG	Yellow/green

Recommended wire diameter for U, V, W and FG: 1mm²

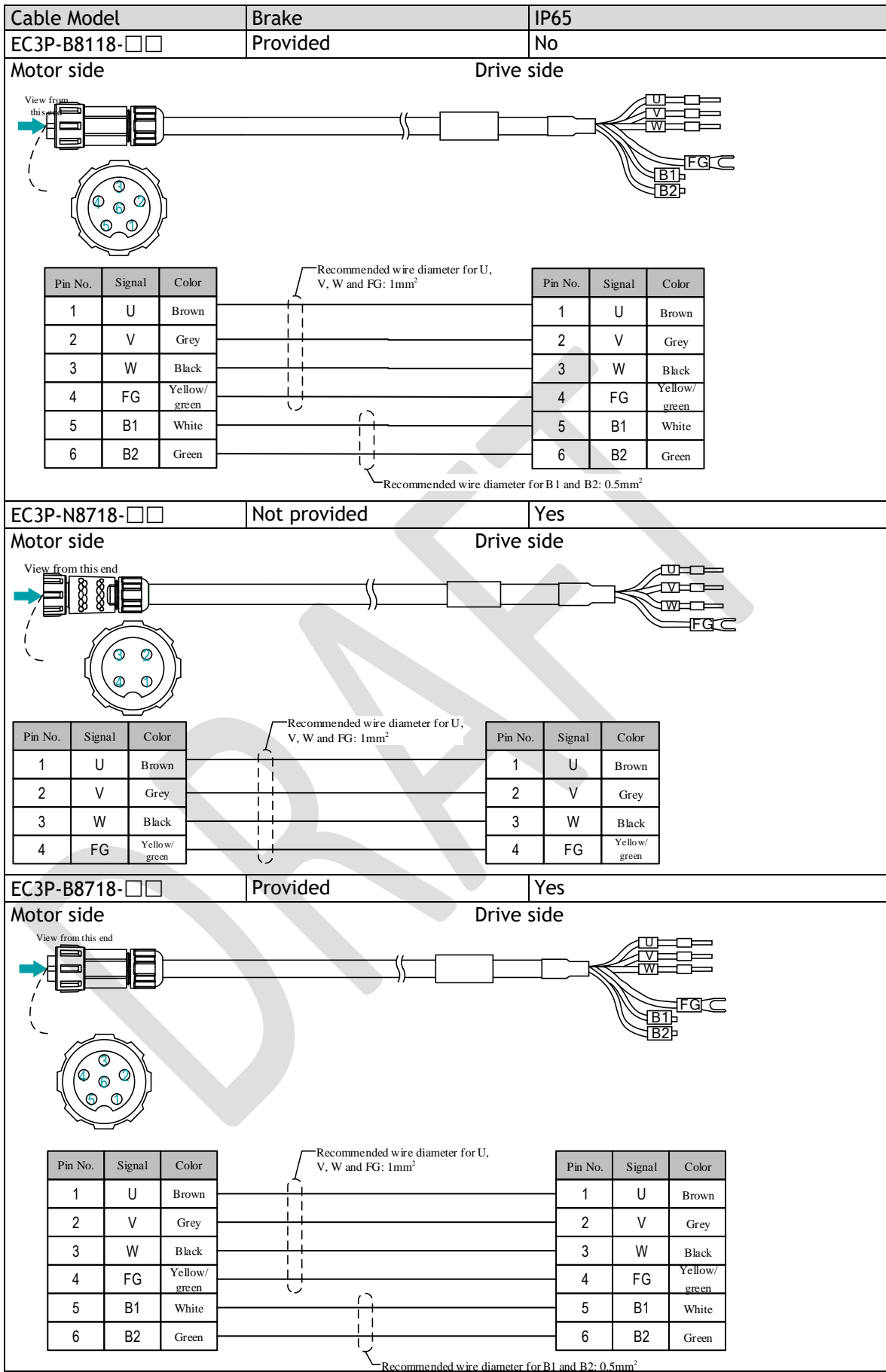
Pin No.	Signal	Color
1	U	Brown
2	V	Grey
3	W	Black
4	FG	Yellow/green

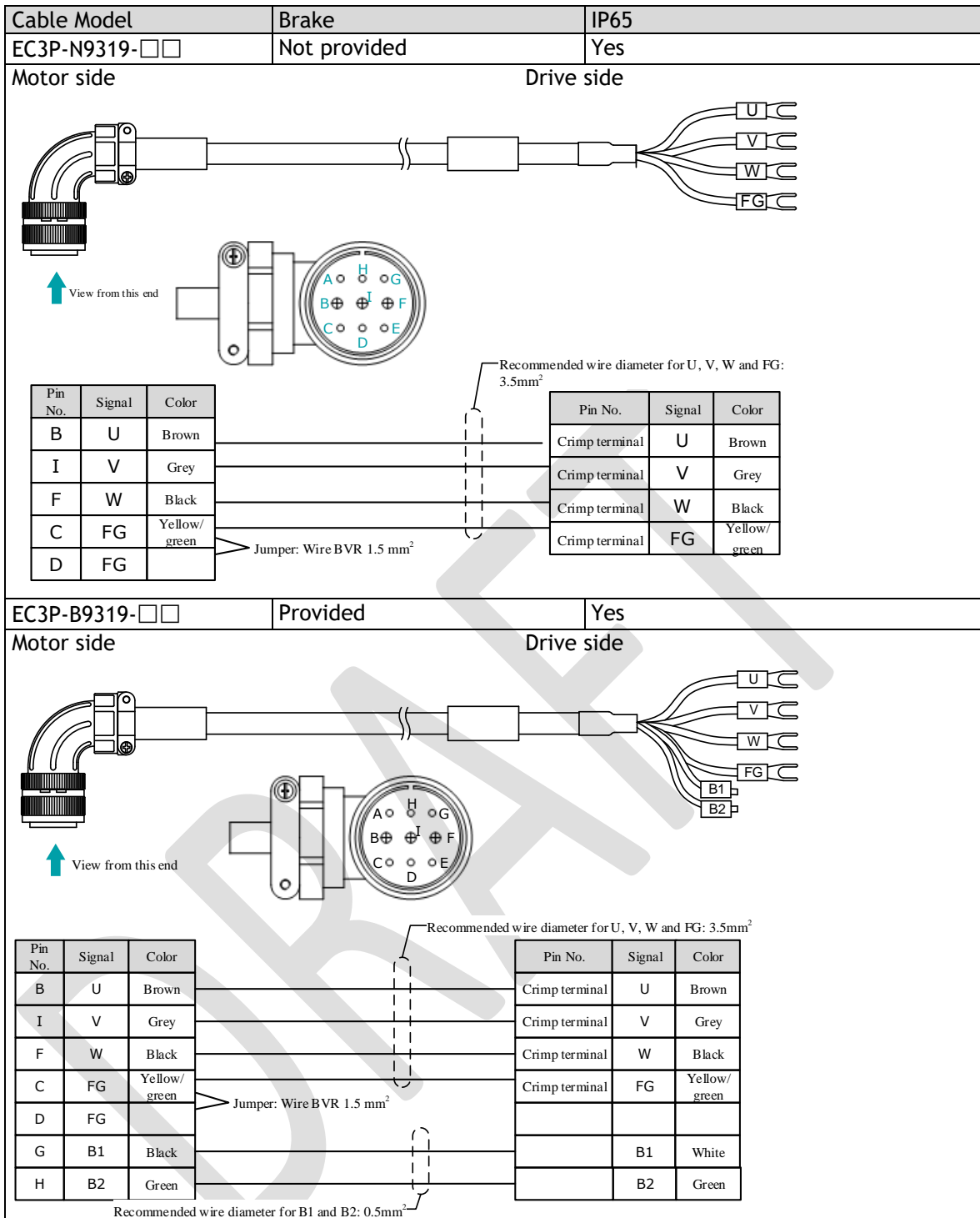

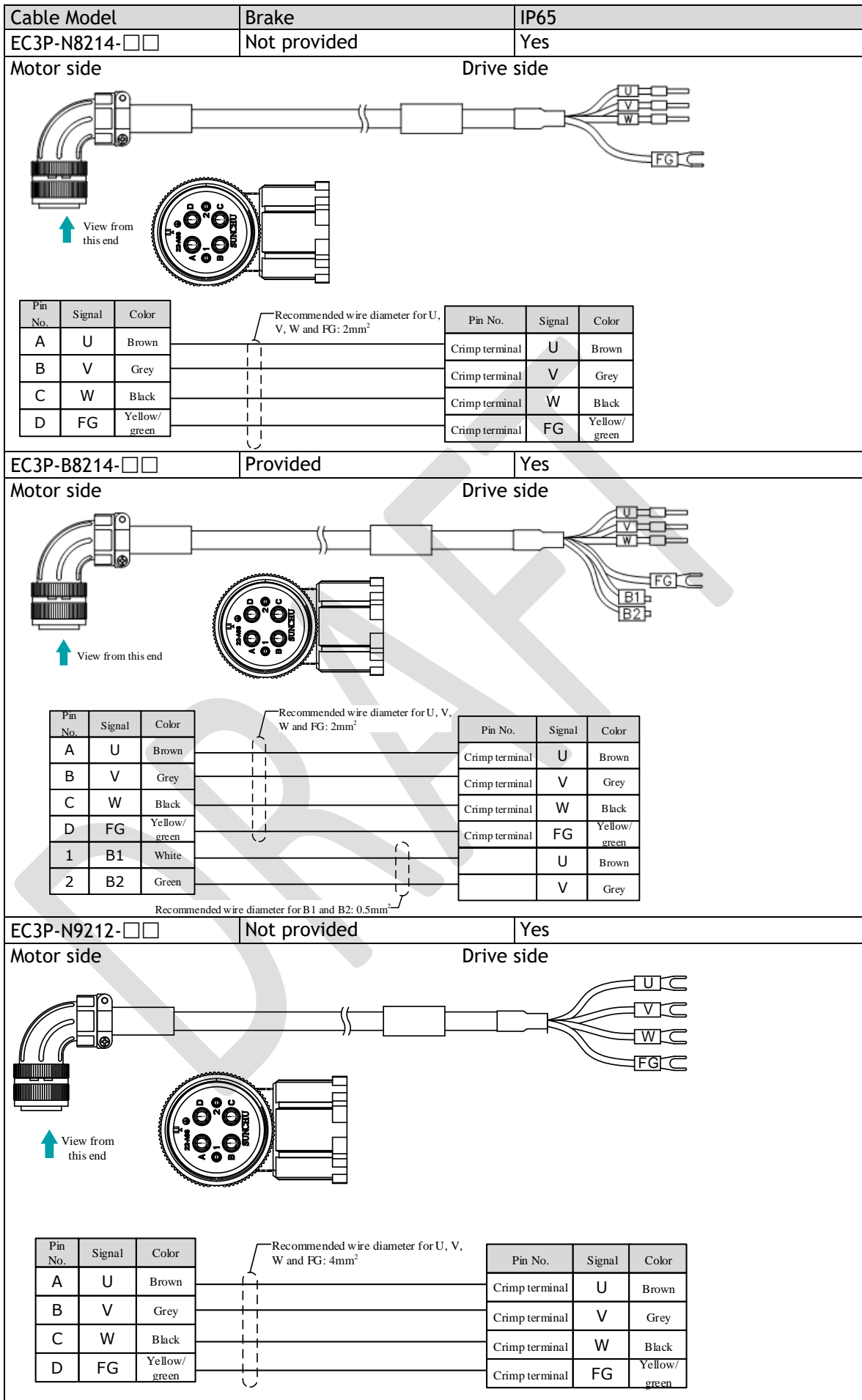

Motor side
Drive side

Pin No.	Signal	Color
A	U	Brown
B	V	Grey
C	W	Black
D	FG	Yellow/green
1	B1	White
2	B2	Green

Recommended wire diameter for U, V, W and FG: 2mm²

Pin No.	Signal	Color
Crimp terminal	U	Brown
Crimp terminal	V	Grey
Crimp terminal	W	Black
Crimp terminal	FG	Yellow/green
	U	Brown
	V	Grey

Motor side
Drive side

Pin No.	Signal	Color
A	U	Brown
B	V	Grey
C	W	Black
D	FG	Yellow/green

Recommended wire diameter for U, V, W and FG: 4mm²

Pin No.	Signal	Color
Crimp terminal	U	Brown
Crimp terminal	V	Grey
Crimp terminal	W	Black
Crimp terminal	FG	Yellow/green

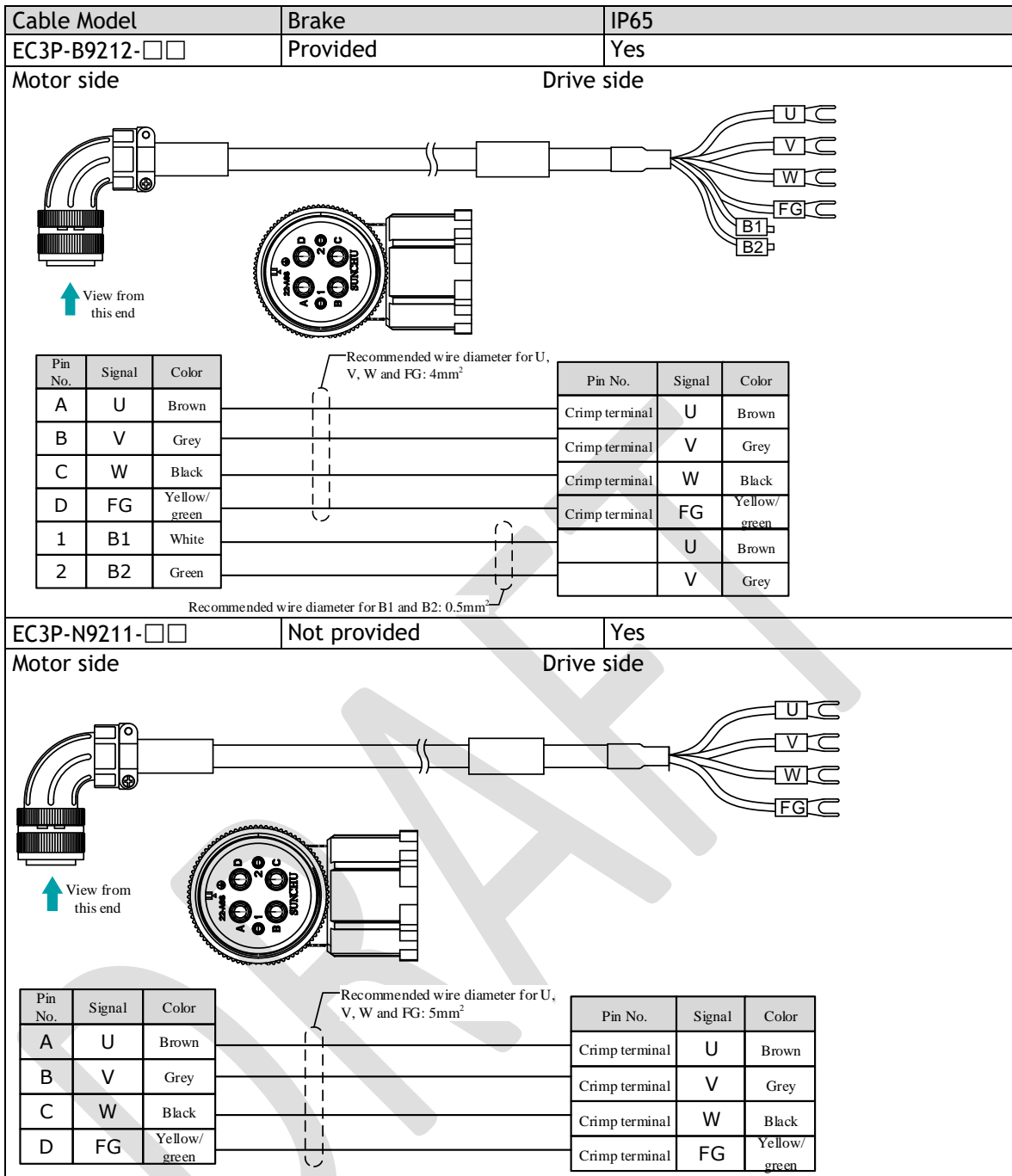

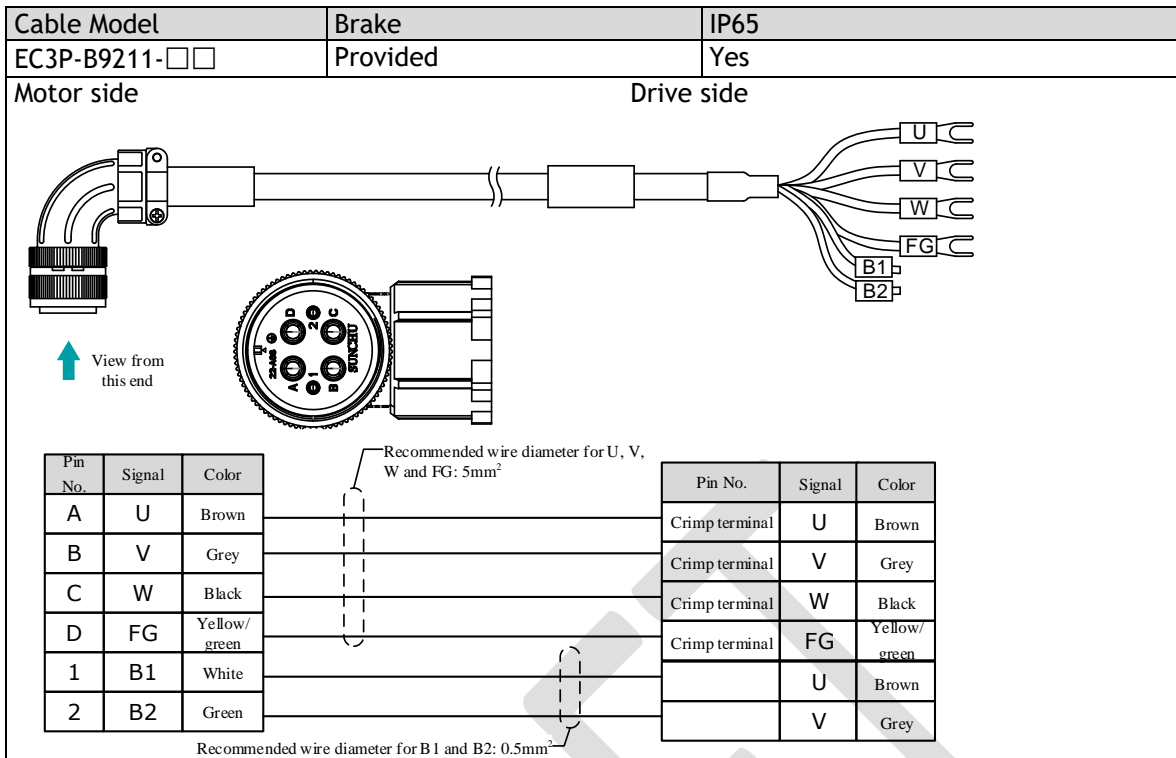

DRAFT

3.4.6 Power Input Wiring Specifications

The power input wiring specification depends on the Motor model. The following table shows the recommended wire gauge for each Drive.

Drive model	Recommended wire gauge		
	AWG		AWG
DX3-1A5AEA	14	2.075	8.2
DX3-101AEA	14	2.075	8.2
DX3-102AEA	14	2.075	8.2
DX3-104AEA	14	2.075	8.2
DX3-108AEA	13	2.627	10.4
DX3-110AEA	13	2.627	10.4
DX3-115AEA	12	3.332	13.1
DX3-120AEA	12	3.332	13.1
DX3-110DEA	14	2.075	8.2
DX3-115DEA	14	2.075	8.2
DX3-120DEA	13	2.627	10.4
DX3-130DEA	13	2.627	10.4
DX3-150DEA	10	5.26	20.8
DX3-175DEA	9	6.63	26.2

3.4.7 Power Input Wiring Example

Rated power from 50W to 400W

Use single-phase 200 VAC to 240 VAC as the power input for the Drives rated power from 50W to 400W.

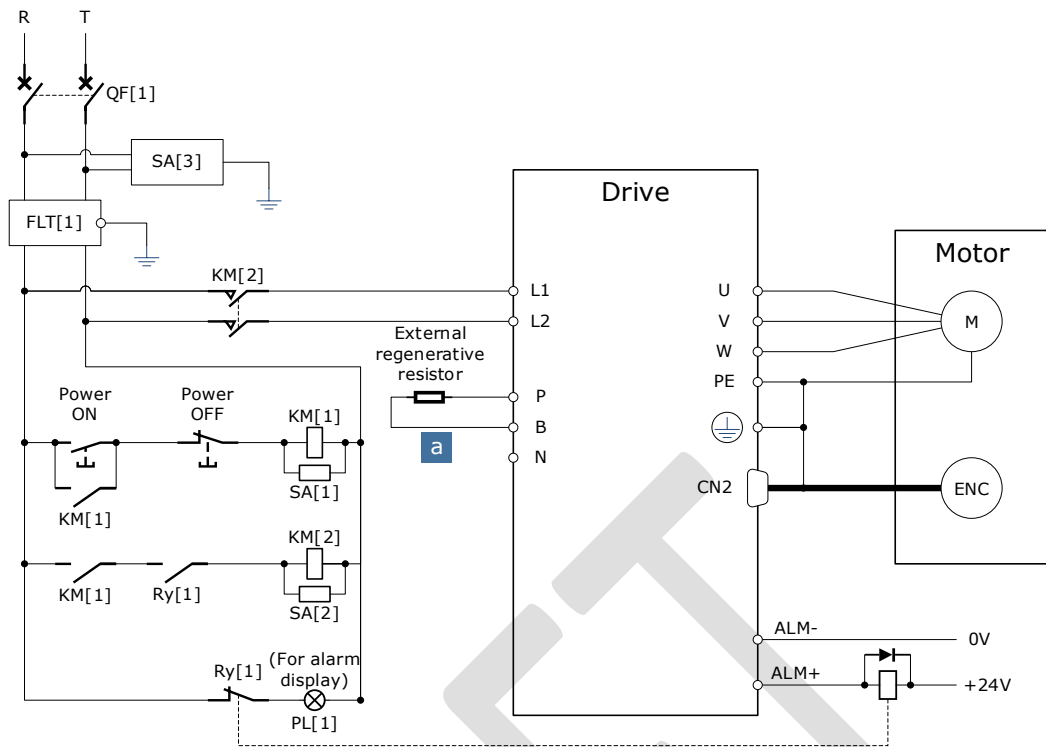

- QF[1]: Molded-case circuit breaker
- SA[3]: Surge Absorber 3
- Ry[1]: Relay
- KM[1]: Magnetic Contactor (for control power supply)
- KM[2]: Magnetic Contactor (for main circuit power supply)
- SA[1]: Surge Absorber 1
- FLT[1]: Noise Filter
- PL[1]: Indicator lamp
- SA[2]: Surge Absorber 2

Rated power from 750W to 2kW

Use single-phase or three-phase 200 VAC to 240 VAC as the power input for the Drives rated power from 750W to 2kW.

The following figure shows the wiring example for using the three-phase AC input power.

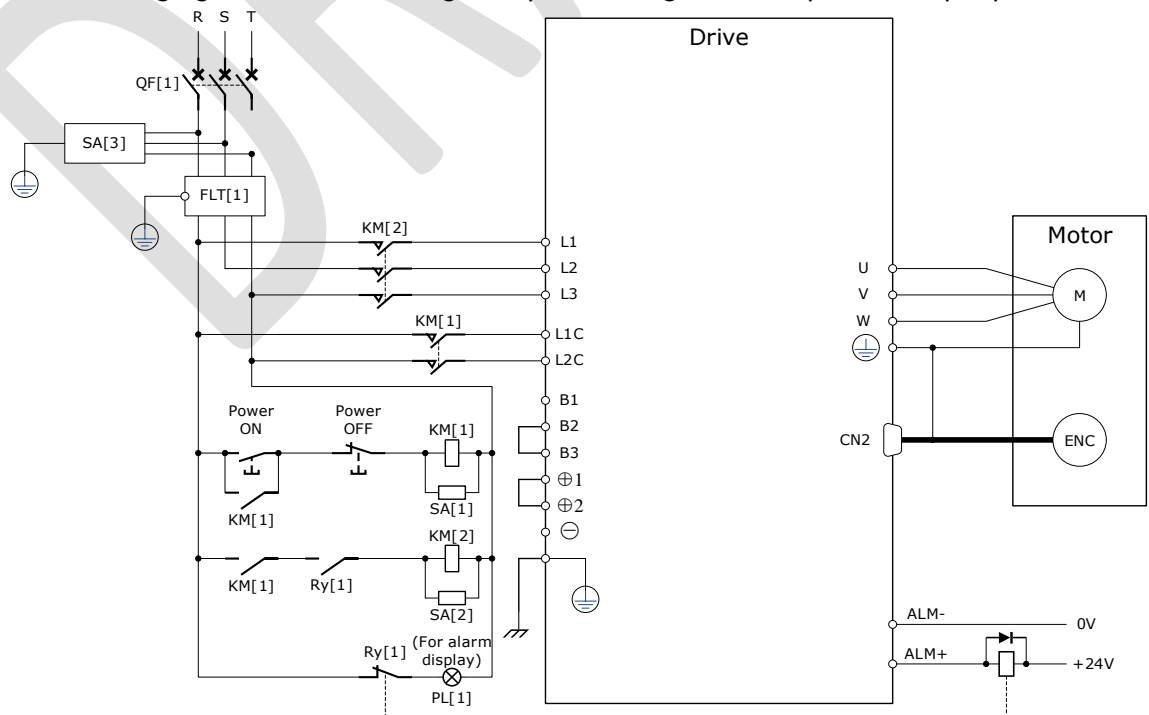

The following figure shows the wiring example for using the single-phase AC input power.

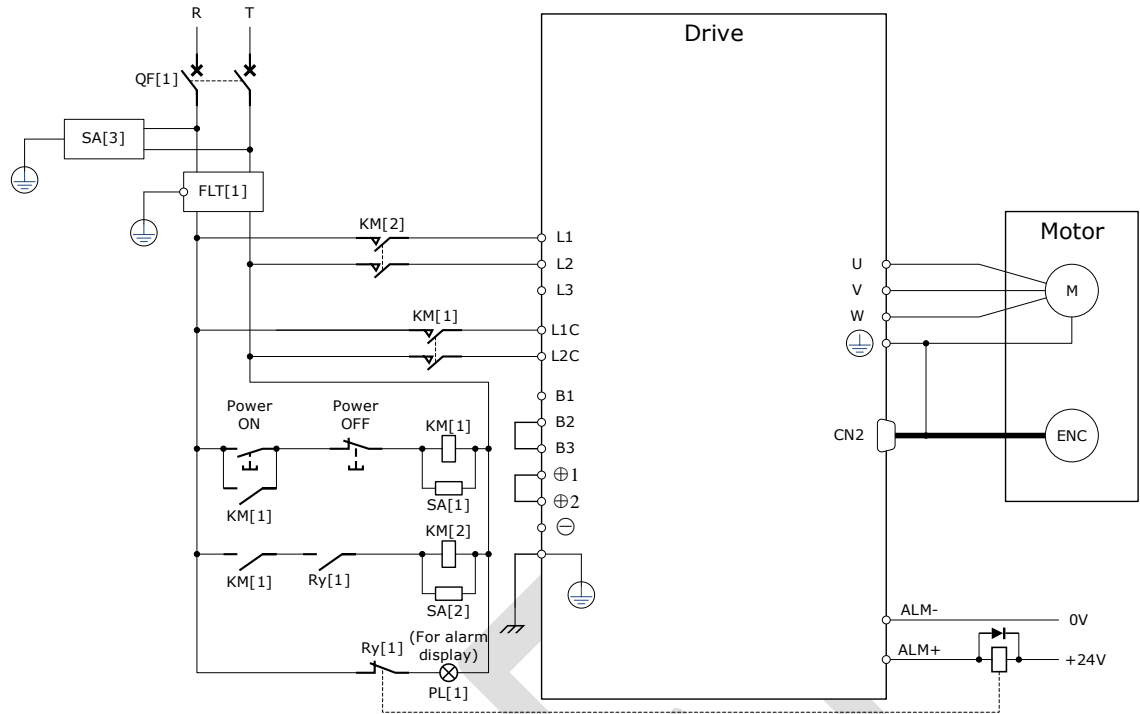

- QF[1]: Molded-case circuit breaker
- SA[3]: Surge Absorber 3
- Ry[1]: Relay
- KM[1]: Magnetic Contactor (for control power supply)
- KM[2]: Magnetic Contactor (for main circuit power supply)
- SA[1]: Surge Absorber 1
- FLT[1]: Noise Filter
- PL[1]: Indicator lamp
- SA[2]: Surge Absorber 2

400VAC, rated power from 1kW to 5kW

Use a three-phase AC 380V-440V as the power input for the drives.

[When using three-phase AC power supply]

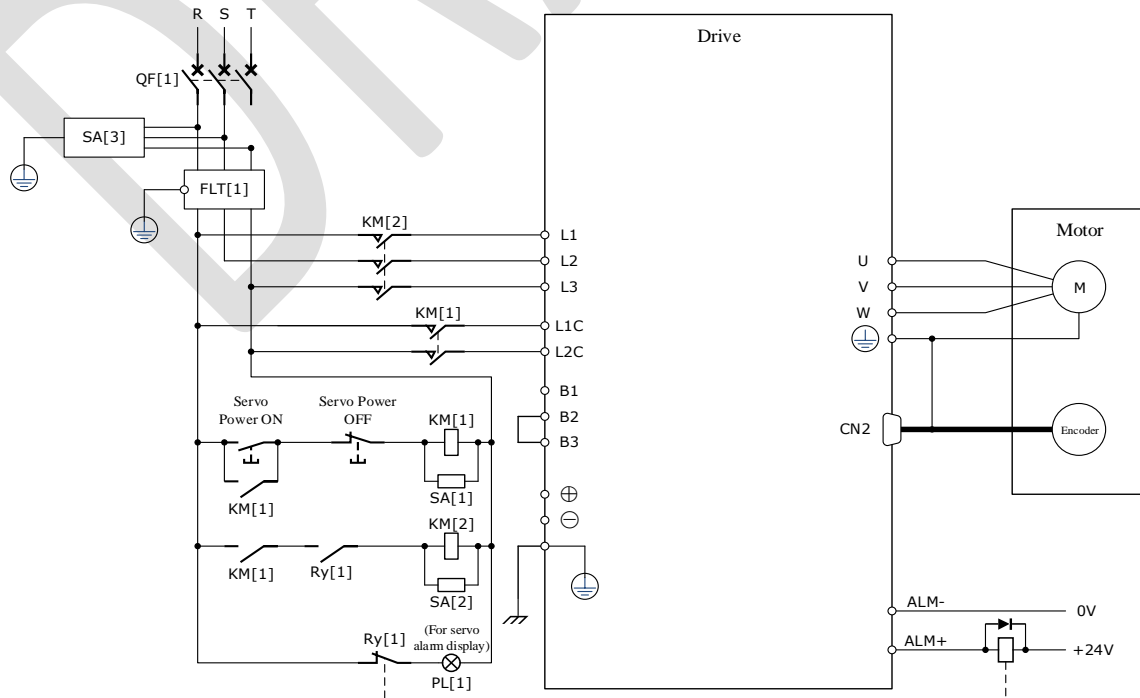

- QF[1]: Circuit breaker
- SA[3]: Surge Absorber 3
- SA[1]: Surge Absorber 1
- FLT[1]: Noise Filter
- SA[2]: Surge Absorber 2

3.5 Wiring the Encoder

3.5.1 Connection Diagram

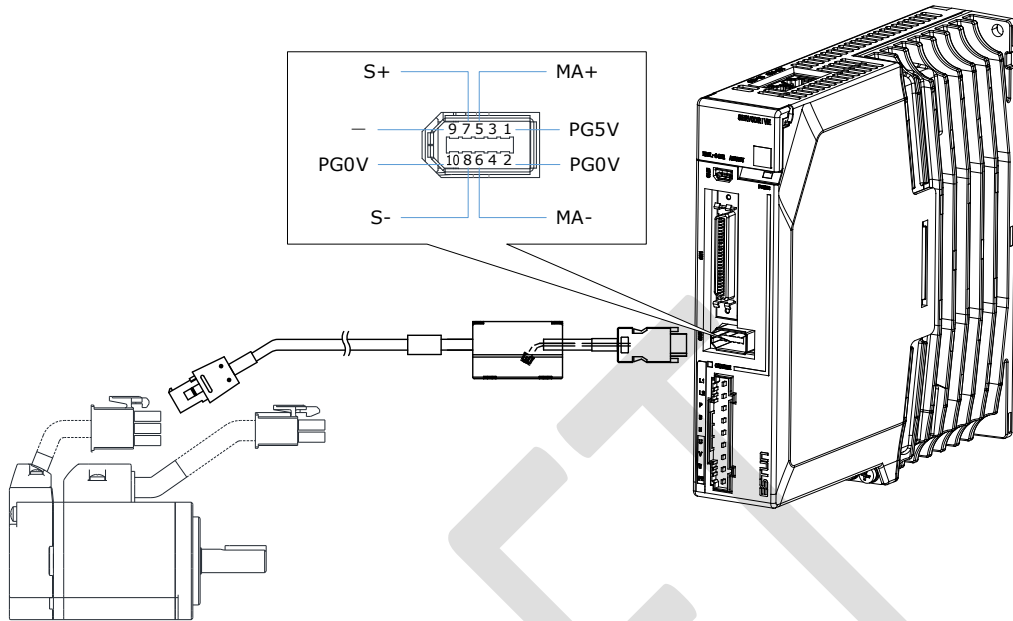

3.5.2 Encoder Cable Description

The encoder cable depends on the Motor model. The common models are shown in the table below.

Motor model	Encoder	IP65 plug	Motor power cable		
			length is 3.0m	length is 5.0m	length is 10.0m
EM3A-A5A EM3A-01A EM3A-02A EM3A-04A EM3A-08A EM3A-10A EM3J-02A EM3J-04A EM3J-08A	Incremental	No	EC3S-I1124-03	EC3S-I1124-05	EC3S-I1124-10
	Absolute	No	EC3S-A1124-03	EC3S-A1124-05	EC3S-A1124-10
	Incremental	Yes	EC3S-I1724-03	EC3S-I1724-05	EC3S-I1724-10
	Absolute	Yes	EC3S-A1724-03	EC3S-A1724-05	EC3S-A1724-10
EM3A-15A EM3A-20A EM3A-20D EM3A-30A EM3A-30D EM3A-40D EM3A-50DLA EM3G all modles	Incremental	Yes	EC3S-I1924-03	EC3S-I1924-05	EC3S-I1924-10
	Absolute	Yes	EC3S-A1924-03	EC3S-A1924-05	EC3S-A1924-10
EMG-10A EMG-15A	Incremental	Yes	EC3S-I1324-03	EC3S-I1324-05	EC3S-I1324-10

Motor model	Encoder	IP65 plug	Motor power cable		
			length is 3.0m	length is 5.0m	length is 10.0m
EMG-20A	Absolute	Yes	EC3S-A1324-03	EC3S-A1324-05	EC3S-A1324-10
EM3G-09A EM3G-13A	Absolute	Yes	EC3S-A1924-03	EC3S-A1924-05	EC3S-A1924-10

3.5.3 Encoder Cable Wiring Specifications

Wiring specifications for encoders vary from model to model. The recommended wire gauge for each model are listed below.

Model	Recommended wire gauge		
	AWG	Cross-sectional area (mm ²)	Rated current (A)
DX3-1A5AEA	14	2.075	8.2
DX3-101AEA	14	2.075	8.2
DX3-102AEA	14	2.075	8.2
DX3-104AEA	14	2.075	8.2
DX3-108AEA	13	2.627	10.4
DX3-110AEA	13	2.627	10.4
DX3-115AEA	12	3.332	13.1
DX3-120AEA	12	3.332	13.1
DX3-110DEA	14	2.075	8.2
DX3-115DEA	14	2.075	8.2
DX3-120DEA	13	2.627	10.4
DX3-130DEA	13	2.627	10.4
DX3-150DEA	10	5.26	20.8
DX3-175DEA	9	6.63	26.2

The following shows the diagram and wiring description of each encoder cable.

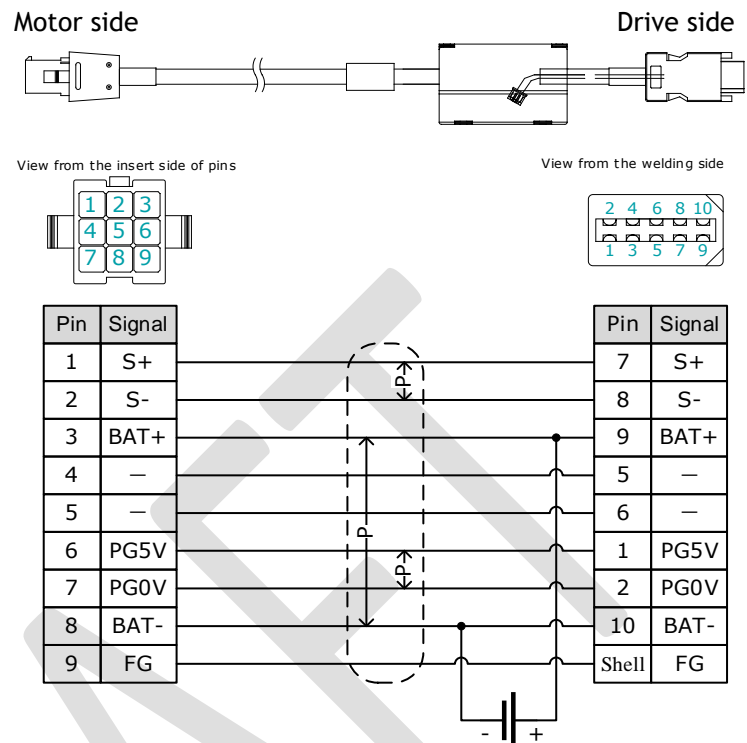
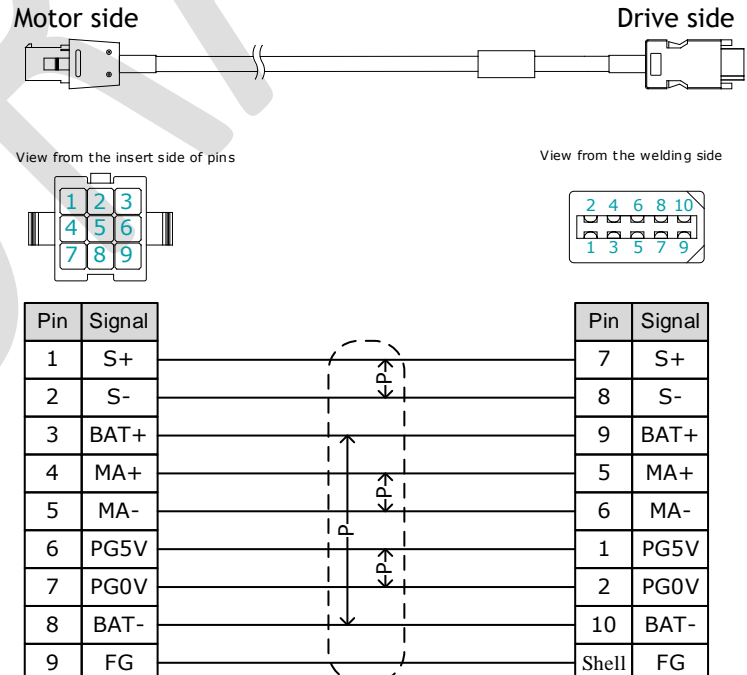
Applicable models	Cable Model	Encoder	IP65 Plug
EM3A-A5ALA2□1 EM3A-01ALA2□1 EM3A-01ATA2□1 EM3A-02ALA2□1 EM3A-02ATA2□1 EM3A-04ALA2□1 EM3A-04ATA2□1 EM3A-08ALA2□1 EM3A-08ATA2□1 EM3A-10ALA2□1 EM3A-10ATA2□1 EM3J-04ALA2□1 EM3J-08ALA2□1	EC3S-A1124-□□ 	Absolute	No
EM3A-01AKA2□1 EM3A-01AFA2□1 EM3A-02AKA2□1 EM3A-02AFA2□1 EM3A-04AKA2□1 EM3A-04AFA2□1 EM3A-08AKA2□1 EM3A-08AFA2□1 EM3A-10AKA2□1 EM3A-10AFA2□1	EC3S-I1124-□□ 	Incremental	No

Applicable models	Cable Model	Encoder	IP65 Plug																																								
EM3A-A5ALA2□2 EM3A-01ALA2□2 EM3A-02ALA2□2 EM3A-04ALA2□2 EM3A-08ALA2□2 EM3A-10ALA2□2	EC3S-A1724-□□	Absolute	Yes																																								
<p>Motor side Drive side</p> <p>View from the insert side of pins View from the welding side</p> <table border="1" style="width: 100%; border-collapse: collapse;"> <thead> <tr> <th>Pin</th> <th>Signal</th> <th>Pin</th> <th>Signal</th> </tr> </thead> <tbody> <tr> <td>1</td> <td>S+</td> <td>7</td> <td>S+</td> </tr> <tr> <td>2</td> <td>S-</td> <td>8</td> <td>S-</td> </tr> <tr> <td>3</td> <td>BAT+</td> <td>9</td> <td>BAT+</td> </tr> <tr> <td>4</td> <td>—</td> <td>5</td> <td>—</td> </tr> <tr> <td>5</td> <td>—</td> <td>6</td> <td>—</td> </tr> <tr> <td>6</td> <td>PG5V</td> <td>1</td> <td>PG5V</td> </tr> <tr> <td>7</td> <td>PG0V</td> <td>2</td> <td>PG0V</td> </tr> <tr> <td>8</td> <td>BAT-</td> <td>10</td> <td>BAT-</td> </tr> <tr> <td>9</td> <td>FG</td> <td>Shell</td> <td>FG</td> </tr> </tbody> </table>				Pin	Signal	Pin	Signal	1	S+	7	S+	2	S-	8	S-	3	BAT+	9	BAT+	4	—	5	—	5	—	6	—	6	PG5V	1	PG5V	7	PG0V	2	PG0V	8	BAT-	10	BAT-	9	FG	Shell	FG
Pin	Signal	Pin	Signal																																								
1	S+	7	S+																																								
2	S-	8	S-																																								
3	BAT+	9	BAT+																																								
4	—	5	—																																								
5	—	6	—																																								
6	PG5V	1	PG5V																																								
7	PG0V	2	PG0V																																								
8	BAT-	10	BAT-																																								
9	FG	Shell	FG																																								
EM3A-01AKA2□2 EM3A-01AFA2□2 EM3A-02AKA2□2 EM3A-02AFA2□2 EM3A-04AKA2□2 EM3A-04AFA2□2 EM3A-08AKA2□2 EM3A-08AFA2□2 EM3A-10AKA2□2 EM3A-10AFA2□2	EC3S-I1724-□□	Incremental	Yes																																								
<p>Motor side Drive side</p> <p>View from the insert side of pins View from the welding side</p> <table border="1" style="width: 100%; border-collapse: collapse;"> <thead> <tr> <th>Pin</th> <th>Signal</th> <th>Pin</th> <th>Signal</th> </tr> </thead> <tbody> <tr> <td>1</td> <td>S+</td> <td>7</td> <td>S+</td> </tr> <tr> <td>2</td> <td>S-</td> <td>8</td> <td>S-</td> </tr> <tr> <td>3</td> <td>BAT+</td> <td>9</td> <td>BAT+</td> </tr> <tr> <td>4</td> <td>MA+</td> <td>5</td> <td>MA+</td> </tr> <tr> <td>5</td> <td>MA-</td> <td>6</td> <td>MA-</td> </tr> <tr> <td>6</td> <td>PG5V</td> <td>1</td> <td>PG5V</td> </tr> <tr> <td>7</td> <td>PG0V</td> <td>2</td> <td>PG0V</td> </tr> <tr> <td>8</td> <td>BAT-</td> <td>10</td> <td>BAT-</td> </tr> <tr> <td>9</td> <td>FG</td> <td>Shell</td> <td>FG</td> </tr> </tbody> </table>				Pin	Signal	Pin	Signal	1	S+	7	S+	2	S-	8	S-	3	BAT+	9	BAT+	4	MA+	5	MA+	5	MA-	6	MA-	6	PG5V	1	PG5V	7	PG0V	2	PG0V	8	BAT-	10	BAT-	9	FG	Shell	FG
Pin	Signal	Pin	Signal																																								
1	S+	7	S+																																								
2	S-	8	S-																																								
3	BAT+	9	BAT+																																								
4	MA+	5	MA+																																								
5	MA-	6	MA-																																								
6	PG5V	1	PG5V																																								
7	PG0V	2	PG0V																																								
8	BAT-	10	BAT-																																								
9	FG	Shell	FG																																								

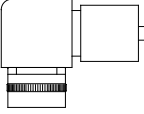
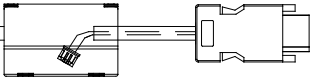
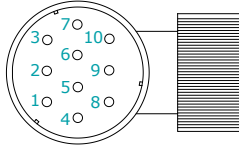
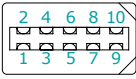
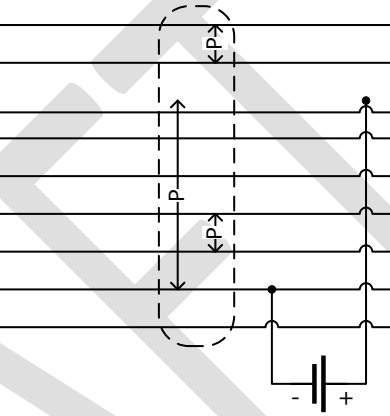
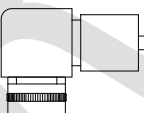
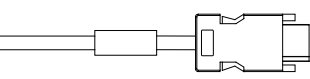
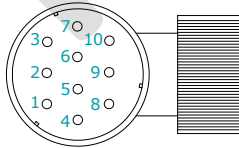
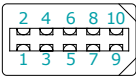
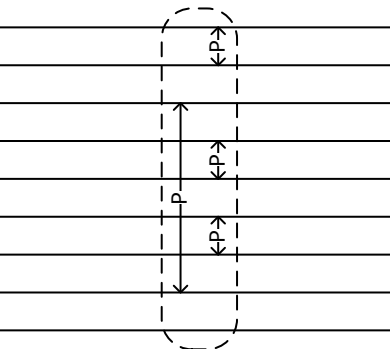
Applicable models	Cable Model	Encoder	IP65 Plug																																								
EMG-10ALB2□ EMG-15ALB2□ EMG-20ALB2□	EC3S-A1324-□□ Motor side  Drive side  View from the insert side of pins  View from the welding side  <table border="1" data-bbox="630 638 766 1019"> <thead> <tr> <th>Pin</th> <th>Signal</th> </tr> </thead> <tbody> <tr><td>1</td><td>S+</td></tr> <tr><td>2</td><td>S-</td></tr> <tr><td>3</td><td>BAT+</td></tr> <tr><td>5</td><td>—</td></tr> <tr><td>6</td><td>—</td></tr> <tr><td>8</td><td>PG5V</td></tr> <tr><td>7</td><td>PG0V</td></tr> <tr><td>4</td><td>BAT-</td></tr> <tr><td>10</td><td>FG</td></tr> </tbody> </table>  <table border="1" data-bbox="1173 638 1308 1019"> <thead> <tr> <th>Pin</th> <th>Signal</th> </tr> </thead> <tbody> <tr><td>7</td><td>S+</td></tr> <tr><td>8</td><td>S-</td></tr> <tr><td>9</td><td>BAT+</td></tr> <tr><td>5</td><td>—</td></tr> <tr><td>6</td><td>—</td></tr> <tr><td>1</td><td>PG5V</td></tr> <tr><td>2</td><td>PG0V</td></tr> <tr><td>10</td><td>BAT-</td></tr> <tr><td>Shell</td><td>FG</td></tr> </tbody> </table>	Pin	Signal	1	S+	2	S-	3	BAT+	5	—	6	—	8	PG5V	7	PG0V	4	BAT-	10	FG	Pin	Signal	7	S+	8	S-	9	BAT+	5	—	6	—	1	PG5V	2	PG0V	10	BAT-	Shell	FG	Absolute	Yes
Pin	Signal																																										
1	S+																																										
2	S-																																										
3	BAT+																																										
5	—																																										
6	—																																										
8	PG5V																																										
7	PG0V																																										
4	BAT-																																										
10	FG																																										
Pin	Signal																																										
7	S+																																										
8	S-																																										
9	BAT+																																										
5	—																																										
6	—																																										
1	PG5V																																										
2	PG0V																																										
10	BAT-																																										
Shell	FG																																										
EMG-10AKB2□ EMG-10AFD2□ EMG-15AFD2□ EMG-20AFD2□	EC3S-I1324-□□ Motor side  Drive side  View from the insert side of pins  View from the welding side  <table border="1" data-bbox="646 1568 782 1948"> <thead> <tr> <th>Pin</th> <th>Signal</th> </tr> </thead> <tbody> <tr><td>1</td><td>S+</td></tr> <tr><td>2</td><td>S-</td></tr> <tr><td>3</td><td>BAT+</td></tr> <tr><td>5</td><td>MA+</td></tr> <tr><td>6</td><td>MA-</td></tr> <tr><td>8</td><td>PG5V</td></tr> <tr><td>7</td><td>PG0V</td></tr> <tr><td>4</td><td>BAT-</td></tr> <tr><td>10</td><td>FG</td></tr> </tbody> </table>  <table border="1" data-bbox="1189 1568 1324 1948"> <thead> <tr> <th>Pin</th> <th>Signal</th> </tr> </thead> <tbody> <tr><td>7</td><td>S+</td></tr> <tr><td>8</td><td>S-</td></tr> <tr><td>9</td><td>BAT+</td></tr> <tr><td>5</td><td>MA+</td></tr> <tr><td>6</td><td>MA-</td></tr> <tr><td>1</td><td>PG5V</td></tr> <tr><td>2</td><td>PG0V</td></tr> <tr><td>10</td><td>BAT-</td></tr> <tr><td>Shell</td><td>FG</td></tr> </tbody> </table>	Pin	Signal	1	S+	2	S-	3	BAT+	5	MA+	6	MA-	8	PG5V	7	PG0V	4	BAT-	10	FG	Pin	Signal	7	S+	8	S-	9	BAT+	5	MA+	6	MA-	1	PG5V	2	PG0V	10	BAT-	Shell	FG	Incremental	Yes
Pin	Signal																																										
1	S+																																										
2	S-																																										
3	BAT+																																										
5	MA+																																										
6	MA-																																										
8	PG5V																																										
7	PG0V																																										
4	BAT-																																										
10	FG																																										
Pin	Signal																																										
7	S+																																										
8	S-																																										
9	BAT+																																										
5	MA+																																										
6	MA-																																										
1	PG5V																																										
2	PG0V																																										
10	BAT-																																										
Shell	FG																																										

Applicable models	Cable Model	Encoder	IP65 Plug
EM3A-15ALB2□4 EM3A-20ALB2□4 EM3G-09ALA2□4 EM3G-13ALA2□4	EC3S-A1924-□□	Absolute	Yes

View from the insert side of pins

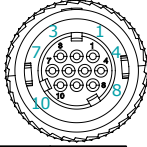

View from the welding side

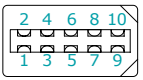

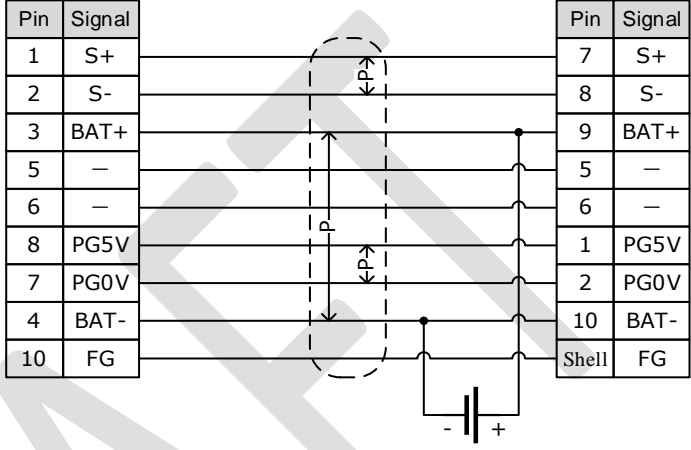
Pin	Signal		Pin	Signal
1	S+		7	S+
2	S-		8	S-
3	BAT+		9	BAT+
5	—		5	—
6	—		6	—
8	PG5V		1	PG5V
7	PG0V		2	PG0V
4	BAT-		10	BAT-
10	FG		Shell	FG

DRAFT

3.5.4 Battery Case Connection



CAUTION

- Absolute encoders are fitted on motors with an encoder type of L; e.g. EM3A-02ALA211. These encoders require a battery supply to retain the absolute encoder data when the Drive power is removed.
- Battery model: LS 14500 (3.6V, AA)
- Replace the battery if the alarm A.47 or A.48 was occurred, and perform the operations Absolute encoder multi-turn reset and Absolute encoder alarm reset.

Follow the instructions below to install or replace the battery case.

Step 1 Turn ON only the control power supply to the Drive.

Step 2 Open the cover of the battery case.

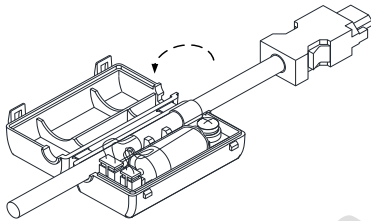

Step 3 Remove the old battery and mount a new battery.

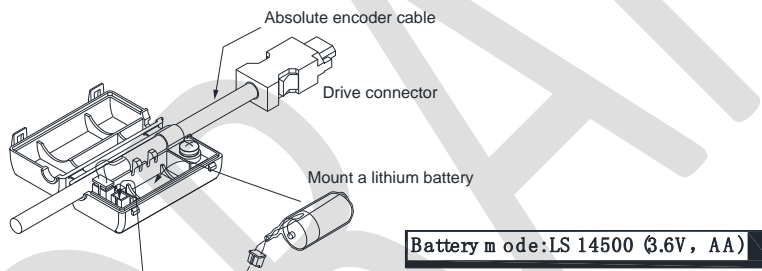

Step 4 Close the cover of the battery case.

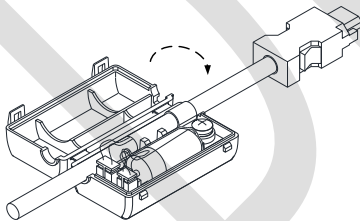

Step 5 Repower up the Drive.

Step 6 Resert the Alarms.



- Perform the Fn011 and Fn010 by Panel Operator to reset the alarms, for details, see the section Fn010 (Absolute encoder multi-turn reset) and Fn011 (Absolute encoder alarm reset).
- Also, you can reset the alarms by ESView V4, for details, see ESView Help Manual.

Step 7 Make sure the alarms have been cleared and the Drive operates normally.

----End

3.6 I/O Signal Connections

3.6.1 Signal Diagram

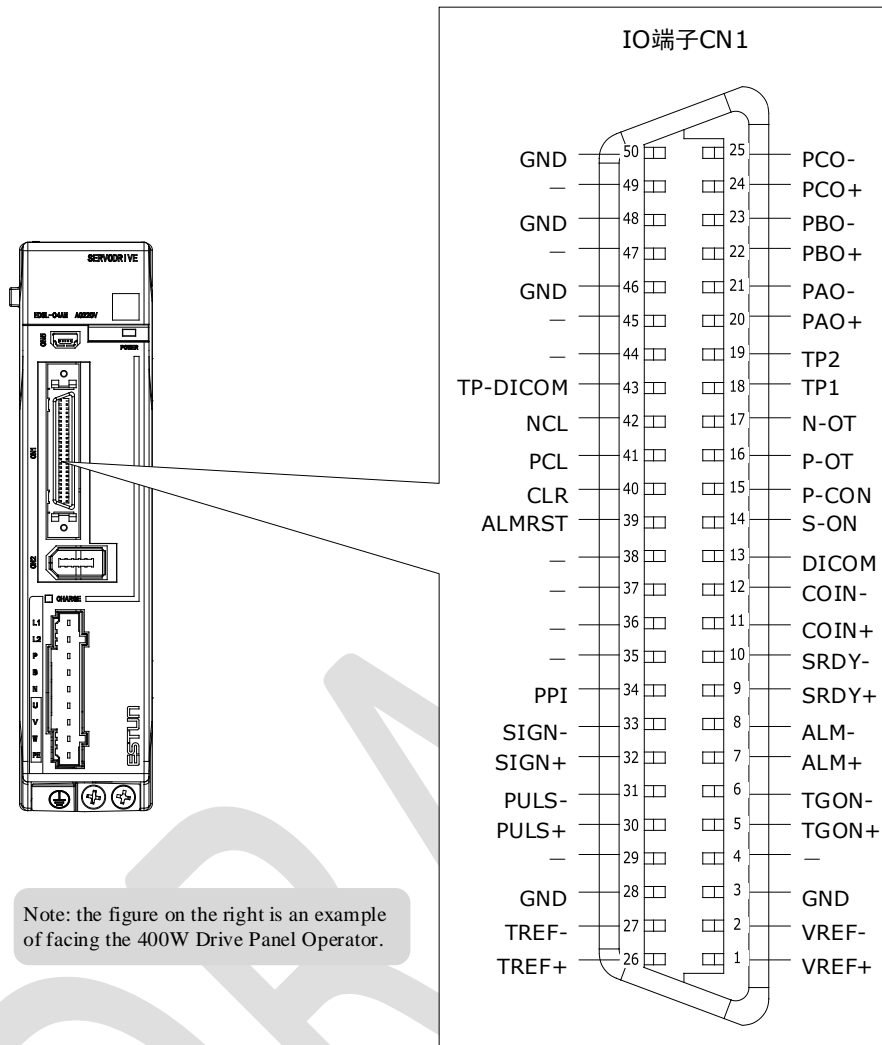

NOTE

The signal definitions for the IO signals of all drives are the same. The signal name in the diagram above is predefined at the factory. You can assign the following signals by Pn509, Pn510, and Pn511, see the section [5.7 IO Signal Allocation](#) in detail.

3.6.2 Pin Layout

Pin	Name	Type	Function
1	VREF+	Input	Speed reference differential input: $\pm 10V$.
2	VREF-	Input	
5	TGON+	Output	Motor rotation test: ON when the motor speed exceeds the set value.
6	TGON-	Output	
7	ALM+	Output	Servo alarm: OFF when an abnormal condition is detected.
8	ALM-	Output	
9	SRDY+	Output	Servo READY: When the control circuit and the main circuit are turned on, it will be ON if there's no alarm and no overtravel for servo.
10	SRDY-	Output	

Pin	Name	Type	Function	
11	COIN+	Output	Positioning completed: ON after positioning is completed (deviation pulse reaches the set value).	
12	COIN-	Output		
13	DICOM	Common	I/O signal power supply, to be supplied by user with a DC 24V power supply. Range of operating voltage: DC 24V±20%	
14	S-ON	Input	Servo ON: Motor becomes the turn-on state.	
15	P-CON	Input	Select the function of this signal by parameter settings.	
			Proportional Control Switch	Change the speed ring control mode from PI control to P control when it is ON.
			Rotation Direction Switch	Use this signal to switch the direction of rotation when the function "Set speed selection internally" is used.
			Control Mode Switch	Switch the control method
			Zero Clamp	When [Speed Control] is ON, the command speed is "0".
			Command Pulse Prohibited	When [Position Control] is ON, the command pulse input will be stopped.
16	P-OT	Input	Overtravel prohibited: Stop the servo motor when it is OFF.	
17	N-OT	Input		
18	TP1	Input	TouchProbe Input	
19	TP2	Input		
43	TP-DICOM	Common	The power supply for the input signal of the TouchProbe is to be supplied by user (DC 24V mains supply). Range of operating voltage: DC 24V±20%	
20	PAO+	Output	Encoder pulse dividing pulse output Phase A	
21	PAO-	Output		
22	PBO+	Output	Encoder pulse dividing pulse output Phase B	
23	PBO-	Output		
24	PCO+	Output	Encoder pulse dividing pulse output Phase C	
25	PCO-	Output		
26	TREF+	Input	Torque reference input. Max input voltage: ±12V	
27	TREF-	Input		

Pin	Name	Type	Function
30	PULS+	Input	Form of pulse input: <ul style="list-style-type: none"> • Symbol + pulse train • CCW+CW • Two-phase orthogonal pulse (90° phase difference)
31	PULS-	Input	
32	SIGN+	Input	
33	SIGN-	Input	
34	PPI	Input	Power supply for open collector command (2K Ω /0.5W resistor is preset inside of the servo drive)
39	ALMRST	Input	Alarm reset: Release the servo alarm state.
40	CLR	Input	Position deviation pulse clear: to clear the position deviation pulse during position control.
41	PCL	Input	Forward Torque Limit
42	NCL	Input	Reverse Torque Limit
3,28,46,48,50	GND	Common	Signal Grounding
Other	-	-	Reserved

3.6.3 Wiring Description

Input Signals Wiring

The input signals of the Drive are divided into two groups, and the details are as following.

Taking the input signal P-OT as an example, Figure 3-2 shows the connection diagram by using an external 24 VDC power supply, and the wiring of other input signals wiring is the same as it.

Figure 3-2 P-OT wiring diagram

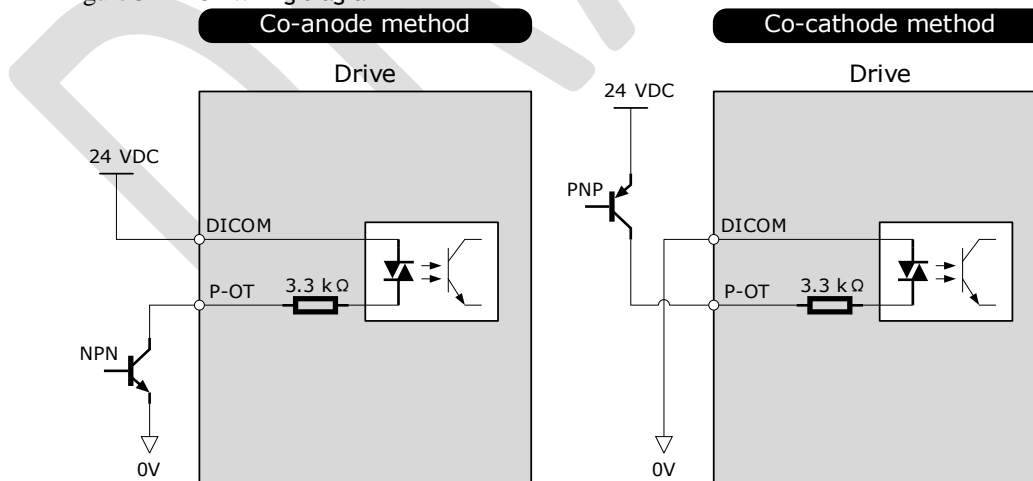

You can assign the input signals by Pn509 and Pn510. For the input signal allocation, see the section 5.7 [IO Signal Allocation](#).

Output Signals Wiring

Taking the output signal TGON as an example, Figure 3-3 shows the connection diagram for using the optocoupler or relay, and the wiring of other output signals wiring is the same as it.

Figure 3-3 TGON wiring diagram

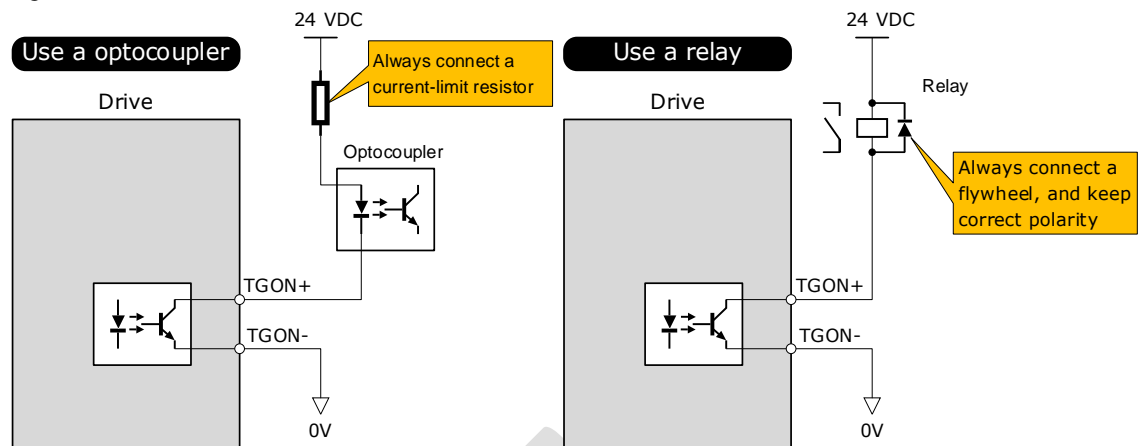

The maximum permissible voltage and current of the optocoupler output circuit inside the servo drive are as follows:

Maximum voltage: 30 VDC
Maximum current: DC 50 mA

You can assign the output signals by Pn511. For the output signal allocation, see the section [5.7 Output Signal Allocations](#).

3.6.4 Holding Brake Wiring

A holding brake is used to hold the position of the moving part of the machine when the Drive is turned OFF so that moving part does not move due to gravity or an external force.

You can use the brake that is built into a Motor with a Brake, or you can provide one on the machine. The holding brake is used in the following cases.

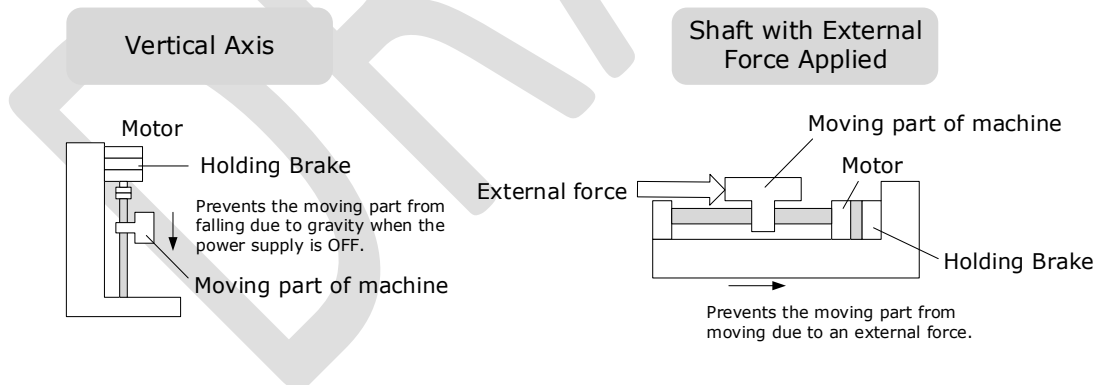

- The brake built into a Motor with a Brake is a de-energization brake. It is used only to hold the Motor and cannot be used for braking. Use the holding brake only to hold a Motor that is already stopped.
- Keep the input voltage at least 21.6 V to make the brake work.
- The wiring of the brake signal has no polarity, please prepare a 24 VDC external power supply.
- Cable of 0.5mm² or above is recommended.

Taking the drives rated from 50W to 400W as an example, Figure 3-4 shows the connection diagram of the holding brake.

Figure 3-4 Holding brake wiring diagram

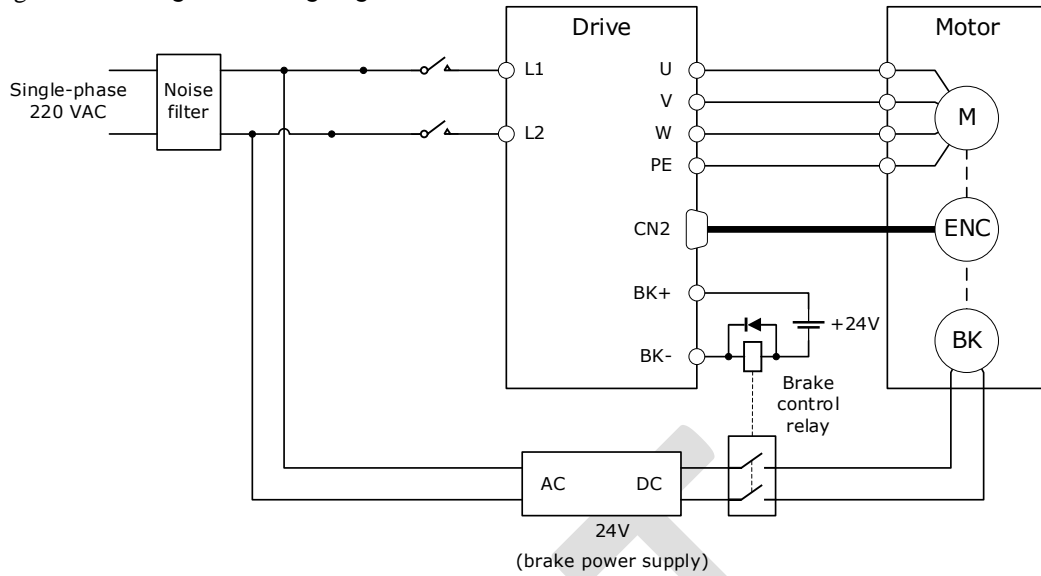

3.6.5 Touch Probe Wiring

You shall only use the terminals CN1-18 (TP1) and CN1-19 (TP2) for Touch Probe input signal, which has been allocated at factory. The following figure shows the example diagram for the connection.

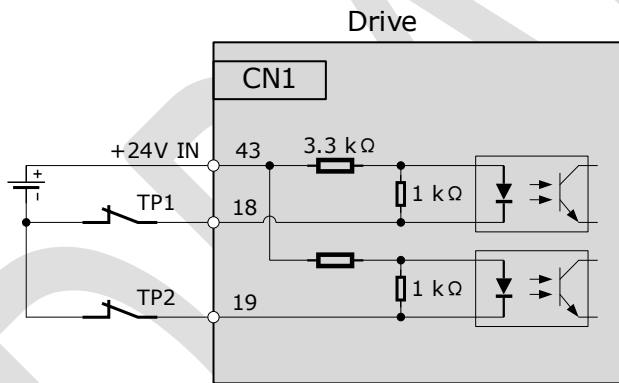

The timing sequence between input signals and trigger is as shown in below.

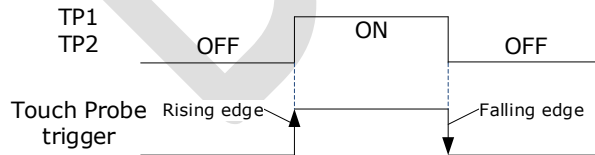

3.7 USB Communication Cable

Connects your PC to a Drive with a USB Communication Cable, in order to make the online operation of ESView V4.

Connection Diagram

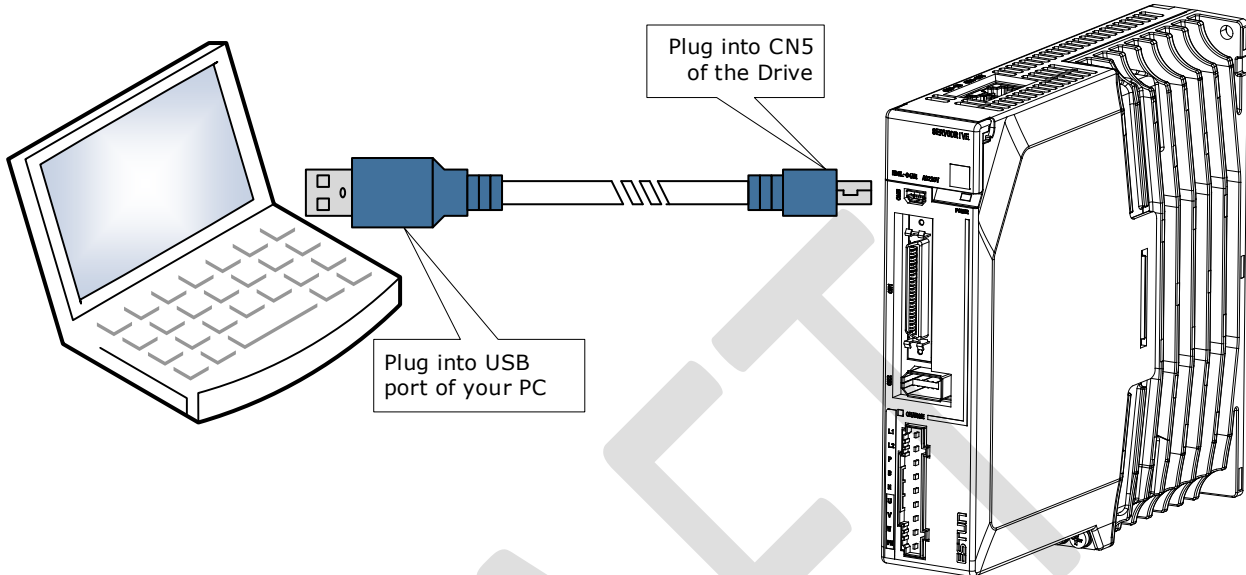

Cable Description

You can purchase the **USB Communication Cable** provided by ESTUN, or you can purchase the commercially available products yourself.

The plug connected to your PC is USB Type-A, and the plug connected to the Drive is Mini USB Type-B.



Chapter 4 Basic Settings

You can implement the functions of parameter setting, display, monitoring, alarm, adjustment, etc. of the Drive in the following two ways.

- Use the Panel Operator of the Drive
- Use the ESView V4 (Recommended)

4.1 Panel Operator

4.1.1 Key Names and Functions

There is a Panel Operator on the front of the Drive, as is shown in Figure 4-1.

Figure 4-1 Diagram of Panel Operator

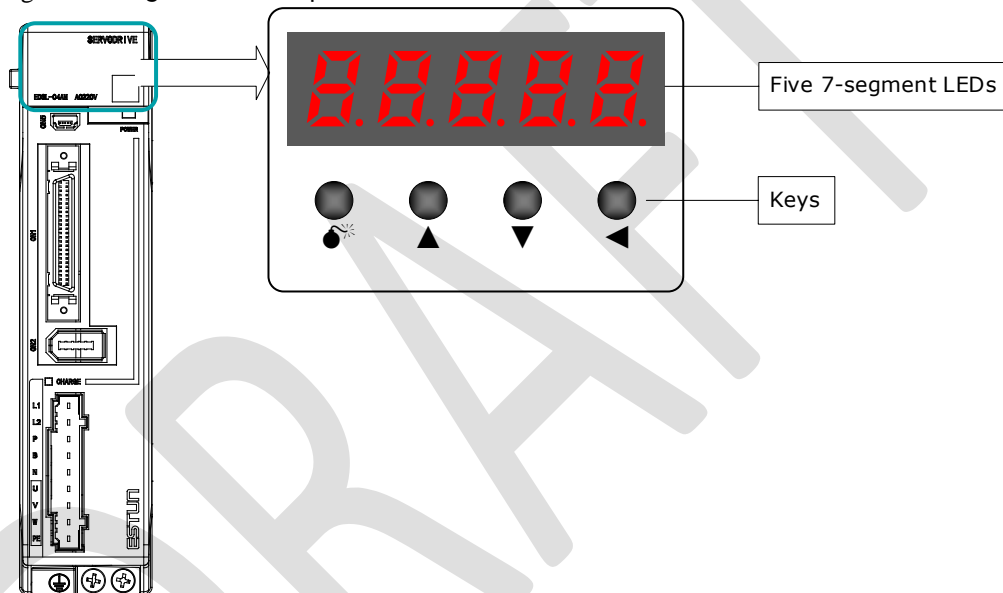

The names and functions of the keys on the Panel Operator are as follows.

Key	Functions
M	Press [M] key to select a basic mode, such as the status display mode, utility function mode, parameter setting mode, or monitor mode.
▲	Press [▲] Key to increase the set value.
▼	Press [▼] Key to decrease the set value.
◀	<ul style="list-style-type: none"> • Data setting key • To display parameter setting and set value. • To shift to the next digit on the left.

4.1.2 Basic Mode Selection

The basic modes include: Status Display Mode, Parameter Setting Mode, Utility Function Mode, and Monitor Mode.

Select a basic mode with [M] key to display the operation status, set parameters and operation references, as is shown in Figure 4-2.

Figure 4-2 Select a basic mode

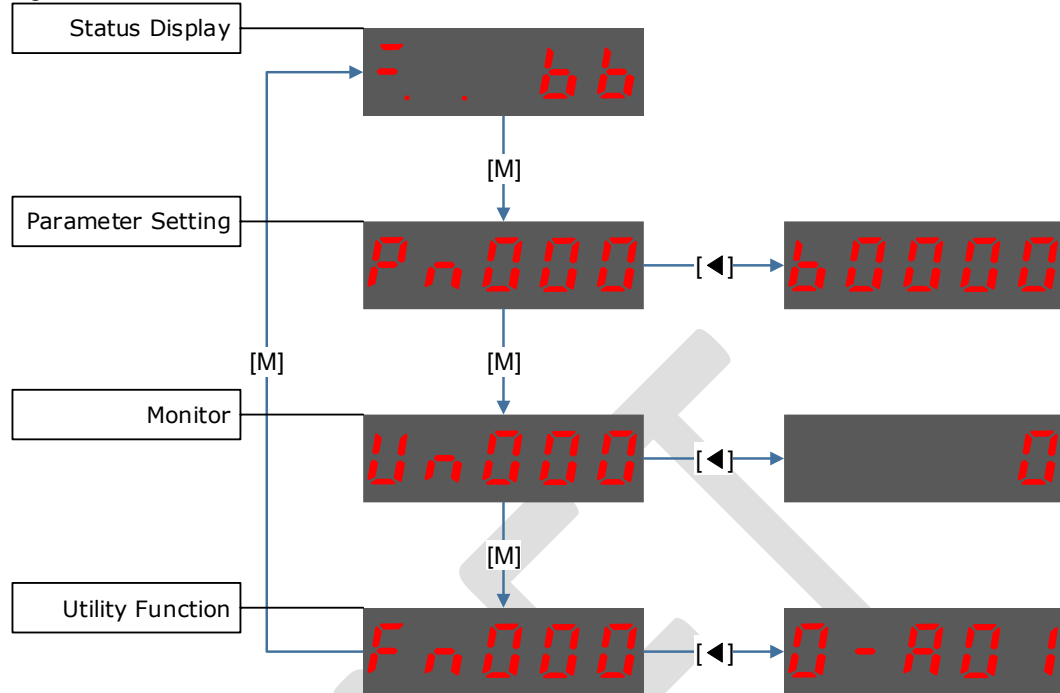

4.1.3 Status Display Mode

Power ON the Drive and wait for a while, the Panel Operator will initially display the Servo Status.

The information displayed by the status is divided into two parts as Figure 4-3:

- The first two digits are called **Bit Data**, what indicates the signal states during the operation of Drive.
- The last three digits are called **Code**, what indicates the operation states of Driv.

Figure 4-3 Status Display

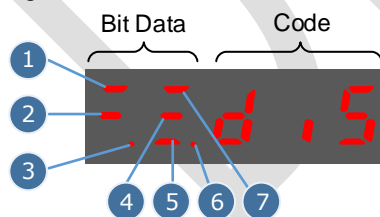







The display meaning of each segment on Bit Data are shown in Table 4-1, and they have different meanings under Speed or Torque Control Mode and Position Control Mode



Table 4-1 Display meaning of each segment on Bit Data

No	Speed Control/Torque Control		Position Control Mode	
	Meaning	Description	Meaning	Description
1	Speed Coincidence (VCMP)	Lit when the difference between the Motor speed and reference speed is the same as or less than the value set in Pn501 (Default setting is 10 rpm). Always lit in Torque Control Mode.	Positioning Completion (COIN)	Lit if error between position reference and actual Motor position is below preset value in Pn500 (Default setting is 10 pulses).
2	Servo OFF	Lit when servo is off. Not lit when servo is on.	Servo OFF	Lit when servo is off. Not lit when servo is on.
3	Control Power ON	Lit when Drive control power is ON.	Control Power ON	Lit when Drive control power is ON.
4	Speed Reference Input	Lit if input speed reference exceeds the value preset in Pn503 (Default setting is 20 rpm).	Reference Pulse Input	ON when the reference pulse is being input. OFF when no reference pulse is input.
5	Torque Reference Input	Lit if input torque reference exceeds preset value (10% rated torque is standard setting).	Deviation Counter Clear Signal Input	Lit when deviation counter clear signal is input.
6	Power Ready	Lit when main power supply circuit is normal.	Power Ready	Lit when main power supply circuit is normal.
7	Rotation Detection (TGON)	Lit if Motor speed exceeds the value preset in Pn503 (Default setting is 20 rpm).	Rotation Detection (TGON)	Lit if Motor speed exceeds the value preset in Pn503 (Default setting is 20 rpm).

The display meanings of Code are shown in Table 4-2.

Table 4-2 Display meanings of Code

Display information	Description
	Servo OFF (Motor Power OFF)
	Servo initialization failed (check the encoder connection)
	Run Servo ON (Motor Power ON)
	Servo Alarm State
	Forward Drive Prohibited
	Reverse Drive Prohibited

Display information	Description
	(Forward and Reverse) Overtravel State
	Alarm Number Display

NOTE: When the Drive is in Servo Alarm State, you shall check and correct the fault according to the Alarm Number Display, and then, you can press [◀] key to try to clear the current alarm.

DRAFT

4.1.4 Parameter Setting Mode

Functions can be selected or adjusted by setting parameters. There are two types of parameters.

- **Function Parameters:** the functions allocated to each digit of the Panel Operator can be selected.
- **Adjustment Parameters:** a parameter is set to a value within the specified range of the parameter.

For a description of the parameter settings, please refer to the section [Chapter 11Parameters](#).

Function Parameters Settin

The example below shows how to change parameter Pn003 (Application Function Selections 3) from **0000** to **1032**.

Step 1 Press [**M**] key several times to select the Parameter Setting Mode.



Step 2 Press [**▲**] key or [**▼**] key to select the parameter Pn003.



Step 3 Press [**◀**] key to display the current value of Pn003.



Step 4 Press and hold [**◀**] key for 1 second or more, and then a flashing decimal point will appear at the bottom right of the 5th digit.



Step 5 Press [**▲**] key twice, changing the value of the 5th digit from **0** to **2**.



Step 6 Press [**◀**] key once, moving the flashing decimal point to the 4th digit.



Step 7 Press [**▲**] key three times, changing the value of the 4th digit from **0** to **3**.



Step 8 Press [**◀**] key twice, moving the flashing decimal point to the 2nd digit.

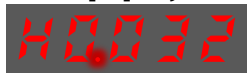

Step 9 Press [**▲**] key once, changing the value of the 2nd digit from **0** to **1**.



Step 10 Press the [**M**] key once to return to the display of Pn003 parameter value.

Step 11 Press the [**M**] key once to display parameter Pn003.



After completing the function parameters setting, restart the Drive to take effect.

----End

Adjustment Parameters Setting

The example below shows how to change parameter Pn102 (Speed Loop Gain) from 100 to 85.

Step 1 Press [M] key several times to select the Parameter Setting Mode.



Step 2 Press [▲] key or [▼] key to select the parameter Pn102.



Step 3 Press [◀] key to display the current value of Pn102.



Step 4 Press [▲] key or [▼] key to change the value to 00085.
Press and hold [▲] key or [▼] key to jump the setting value quickly.



Step 5 Press [◀] key or [M] key to return to the display of Pn102.

---- End

Panel Operator can only display 5 digits. The value of some adjustment parameters will be 6 digits or more. The display of the parameter values is as follows (take the display of parameter value -41943040 as an example).

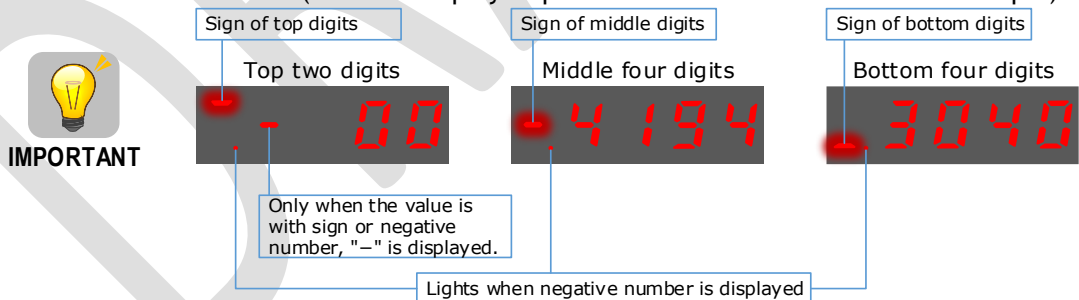

The example below shows how to change parameter Pn504 (Deviation Counter Overflow Alarm) from 41943040 to 42943240.

Step 6 Press [M] key several times to select the Parameter Setting Mode.



Step 7 Press [▲] key or [▼] key to select the parameter Pn504.



Step 8 Press [◀] key to display bottom four digits of the current value of Pn504.



Step 9 Press and hold [◀] key for 1 second or more, and then a flashing decimal point will appear at the bottom right of the 5th digit.



Step 10 Press [◀] key twice, moving the flashing decimal point to the 3rd digit.



Step 11 Press [▲] key twice, changing the value of the 3rd digit from 0 to 2.



Step 12 Press [◀] key four times, moving the flashing decimal point to the 3rd of middle four digits.



Step 13 Press [▲] key once, changing the value of the 3rd digit from 1 to 2.



Step 14 Press the [M] key once to return to the display of Pn504 parameter value.

Step 15 Press the [M] key once to display parameter Pn504.

---- End

4.1.5 Monitor Mode

The Monitor Mode can be used for monitoring the reference values, I/O signal status, and Drive internal status.

The Monitor Mode can be selected during Motor operation.

Select Monitor Mode

The example below shows how to display, the contents of monitor number Un003 (when the Motor rotates at 100).

Step 1 Press [M] key several times to select the Monitor Mode.

A digital display showing the text "Un000" in red characters on a black background.

Step 2 Press [▲] key or [▼] key to select the monitor number Un003.

A digital display showing the text "Un003" in red characters on a black background.

Step 3 Press [◀] key to display the data of Un003.

A digital display showing the number "100" in red characters on a black background.

Step 4 Press [◀] key to return to the display of Un003.

---- End

Contents of Monitor Mode Displa

Monitor Number	Content of Display	Unit
Un000	Motor speed	rpm
Un001	Input value of speed reference	rpm
Un002	Input percentage of torque reference (relative to rated torque)	%
Un003	Internal torque reference (in percentage to the rated torque)	%
Un004	Encoder Rotation angle pulse number	–
Un005	Input signal monitor	–
Un006	Touch Probe signal monitoring	–
Un007	Output signal monitor	–
Un008	Number of input pulses within 1ms	1 pulse
Un009	Input reference pulse counter	–
Un011	Pulse deviation counter	–
Un013	Reference pulse	1 pulse
Un015	Percentage of load inertia	–
Un016	Motor Overload Ratio	%
Un019	Busbar Voltage	V

Monitor Number	Content of Display	Unit
Un021	Encoder temperature	°C
Un022	Main board temperature	°C
Un024	PCP target position	–

The status (low level or high level) of input signal allocated to each input terminal is displayed.

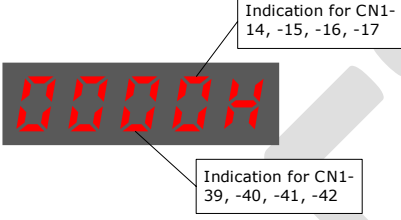
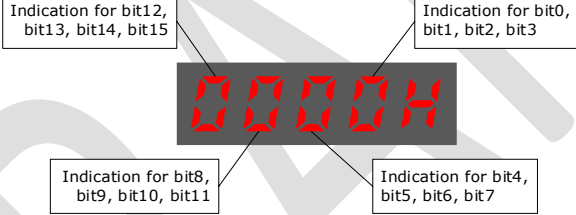
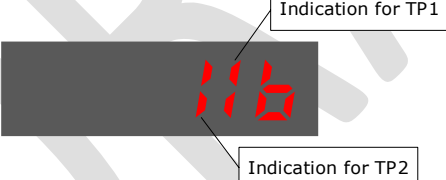
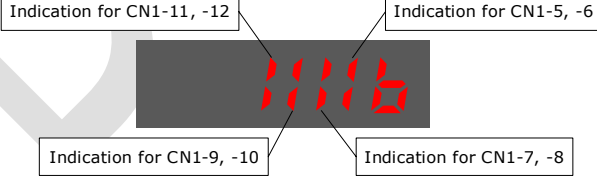
Monitor Number	Monitoring data	Description
Un005	<ul style="list-style-type: none"> When it indicates digital IO:  When it indicates virtual IO:  	<p>The value of Hexadecimal, and each bit indicates the signal status of 4 channels.</p> <p>Range: 0000 (0) to1111 (F) 0=Low level; 1=High level</p> <p>The status corresponds to the corresponding pin from right to left.</p>
Un006		<p>The value of Binary, and each column indicates the signal state of 1 channel.</p> <p>0=Low level; 1=High level</p>
Un007		<p>The value of Binary, and each column indicates the signal state of 1 channel.</p> <p>0=Low level; 1=High level</p>

NOTE: Un007 represents the state of the output signal. The optocoupler ON and OFF of each output signal depends on whether the output signal is inverted:
 If the signal is not inverted, lit for turning the optocoupler ON, and not lit for turning the optocoupler OFF.
 If the signal is inverted, lit for turning the optocoupler OFF, and not lit for turning the optocoupler ON.

4.1.6 Utility Function Mode

This section describes how to apply the basic operations using the Panel Operator to run and adjust the Motor.

The following table shows the parameters in the Utility Function Mode.

Function Number	Name
Fn000	Alarm trace data display
Fn001	Initialize parameter settings
Fn002	JOG operation
Fn003	Auto adjustment of speed reference offset
Fn004	Manual adjustment of speed reference offset
Fn005	Automatic offset-adjustment of Motor current detection signal
Fn006	Manual offset-adjustment of Motor current detection signal
Fn007	Software version display
Fn009	Load inertia identification
Fn010	Absolute encoder multi-turn reset
Fn011	Absolute encoder alarm reset
Fn017	Auto-tuning tool
Fn018	PJOG operation

Fn000 (Alarm trace data display)

The alarm trace data display can display up to ten previously occurred alarms. The following are the steps to display the alarm trace data.

Step 1 Press [M] key several times to select the Utility Function Mode.

Step 2 Press [▲] key or [▼] key to select the function number Fn000.

Step 3 Press [◀] key to display latest alarm number.

Step 4 Press [▲] key or [▼] key to view the other alarm data.

Step 5 Press the [◀] key to return to the display of the Fn000.
Press and hold [◀] key for 1 second or more to clear all the alarm trace data.

----End

Fn001 (Initialize parameter settings)

The following are the steps to initialize parameter settings.

Step 1 Press [M] key several times to select the Utility Function Mode.

Step 2 Press [▲] key or [▼] key to select the function number Fn001.

Step 3 Press [◀] key, and Panel Operator displays as below.

Step 4 Press and hold [◀] key for 1 second to initialize the parameter settings, until Panel Operator displays and blinks done, which indicates the initialization of parameter setting has been completed.

Step 5 Release [◀] key to return to the display of the Fn001.

----End

Fn002 (JOG operation)

This utility function often used for trial operation, refers to the section 7.3.3 JOG Operation

Fn003 (Auto Adjustment of Speed Reference Offset)

For speed control, even if the speed reference is 0V (command reference is 0 or stopped), the servo motor may move at a very low speed. By this moment, use the offset adjustment function to clear the offset. Refer to "5.9.2 Adjustment of Speed Reference Offset".

Fn004 (Manual Adjustment of Speed Reference Offset)

Refer to "5.9.2 Adjustment of Speed Reference Offset" when using the Manual Adjustment of Speed Reference Offset.

Fn005 (Automatic offset-adjustment of Motor current detection signal)

Motor current detection offset adjustment has performed at ESTUN before shipping. Basically, the user need not perform this adjustment.

**IMPORTANT**

- Execute the automatic offset adjustment if the torque ripple is too big when compared with that of other Drives.
- Execute the automatic offset adjustment in the servo OFF state.

The following are the steps to execute the automatic offset adjustment.

Step 1 Press [M] key several times to select the Utility Function Mode.

Step 2 Press [▲] key or [▼] key to select the function number Fn005.

Step 3 Press [◀] key, and Panel Operator displays as below.

Step 4 Press [M] key to execute the automatic offset adjustment.
Panel Operator displays and blinks **done**, and 2 seconds later, it will return to previous

2秒后

display.

Step 5 Press the [◀] key to return to the display of the Fn005.

---- End

Fn006 (Manual offset-adjustment of Motor current detection signal)

To adjust the offset, perform the automatic adjustment (Fn005) first. And if the torque ripple is still big after the automatic adjustment, perform the manual offset-adjustment as follow.

**IMPORTANT**

- Please carefully execute the manual offset-adjustment, in case worsen the characteristics of the Motor.
- When executing the manual offset-adjustment, run the Motor at a speed of approximately 100 rpm, and adjust the phase-U and phase-V offsets alternately several times until the torque ripple is minimized.

Step 1 Press [M] key several times to select the Utility Function Mode.

Step 2 Press [▲] key or [▼] key to select the function number Fn006.

Step 3 Press [◀] key, and Panel Operator displays as below.

Step 4 Press [M] key for switching the display between 0_CuA (phase-U) and 1_CuB (phase-V).

Step 5 Select one phase display (e.g. 1_CuB, phase-V), and press and hold [◀] key for 1 second or more, Panel Operator will display the current offset value.

Step 6 Press [▲] key or [▼] key to change the offset value.

NOTE: the offset can be adjusted from -1024 to 1024.

Step 7 Press and hold [◀] key for 1 second or more to return to the phase display.

Step 8 Press [◀] key to return to the display of the Fn006.

----End

Fn007 (Software version display)

The following are the steps to display the software versions.

Step 1 Press [M] key several times to select the Utility Function Mode.

Fn000

Step 2 Press [▲] key or [▼] key to select the function number Fn007.

Fn007

Step 3 Press [◀] key to display the software versions.

Step 4 Press [M] key several times to display between DSP version, Voltage class and Structure code.

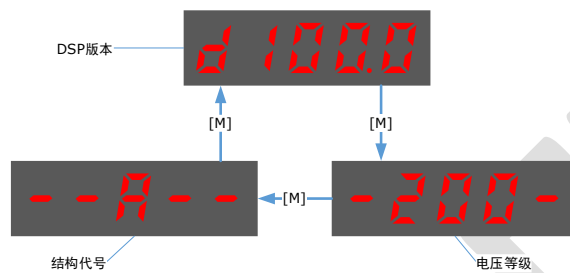

Step 5 Press [◀] key to return to the display of the Fn007.

----End

Fn009 (Load inertia identification)

This utility function often used for tuning, refers to the section 8.7.1 Load inertia identification.

Fn010 (Absolute encoder multi-turn reset)

The following are the steps to reset the absolute encoder multi-turn data.

Step 1 Press [M] key several times to select the Utility Function Mode.

Fn000

Step 2 Press [▲] key or [▼] key to select the function number Fn010.

Fn010

Step 3 Press [◀] key, and Panel Operator displays as below.

C-P05

Step 4 Press [M] key to reset the absolute encoder multi-turn data.

CLr--

Step 5 Press [◀] key to return to the display of the Fn010.

----End

Fn011 (Absolute encoder alarm reset)

The following are the steps to reset the absolute encoder alarm.

Step 1 Press [M] key several times to select the Utility Function Mode.

A digital display showing the text "Fn000" in red characters on a black background.

Step 2 Press [▲] key or [▼] key to select the function number Fn011.

A digital display showing the text "Fn011" in red characters on a black background.

Step 3 Press [◀] key, and Panel Operator displays as below.

A digital display showing the text "C-Err" in red characters on a black background.

Step 4 Press [M] key to reset the absolute encoder multi-turn data.

A digital display showing the text "CLR--" in red characters on a black background.

Step 5 Press [◀] key to return to the display of the Fn011.

----End

Fn017 (Auto-tuning tool)

This utility function often use used for tuning, refers to the section 8.3.2 [Auto-Tuning Tool](#).

Fn018 (PJOG operation)

This utility function often used for trial operation, refers to the section 7.5 [Error! Reference source not found.](#)

4.2 ESView V4

4.2.1 Installation

System Requirements

You need to provide for your own personal computer that meets the following basic hardware requirements.

Item	Description
OS	Windows 7 (32 位/64 位) Windows 10 (32 位/64 位) English (US), Chinese (Simply) version of the OS above.
CPU	1.6 GHz processor or more
Memory	System memory of 1 GB or more Graphics memory of 64 MB or more
Hard Disk	Free space of 1GB or more
Communication	USB; RJ45
Display	1,024×768 PIXEL or more 24bit color (TrueColor) or more

Preparation

Please prepare the Windows operating system, communication cable, and a decompression software in advance.

Visit ESTUN official website www.estun.com to find and download ESView V4 on Technical Support > Download for getting the compressed file. For help, please contact ESTUN.

- Turn on the power supply of PC and start Windows. (Close down other software running.)
- Copy *ESView V4* compressed file into an appropriate folder.
- Disconnect if the Drive is connected to the PC with the cable.

Install Software

Close other running software before installing the software and confirm that the Windows user has administrator privileges.

Step 1 Extract the *ESView V4* compressed file in an appropriate directory of your PC.

Step 2 Double click the *ESView V4* installation program.
The installation program will automatically start, as shown in theFigure 4-4.

Figure 4-4 Start to install ESView V4 software

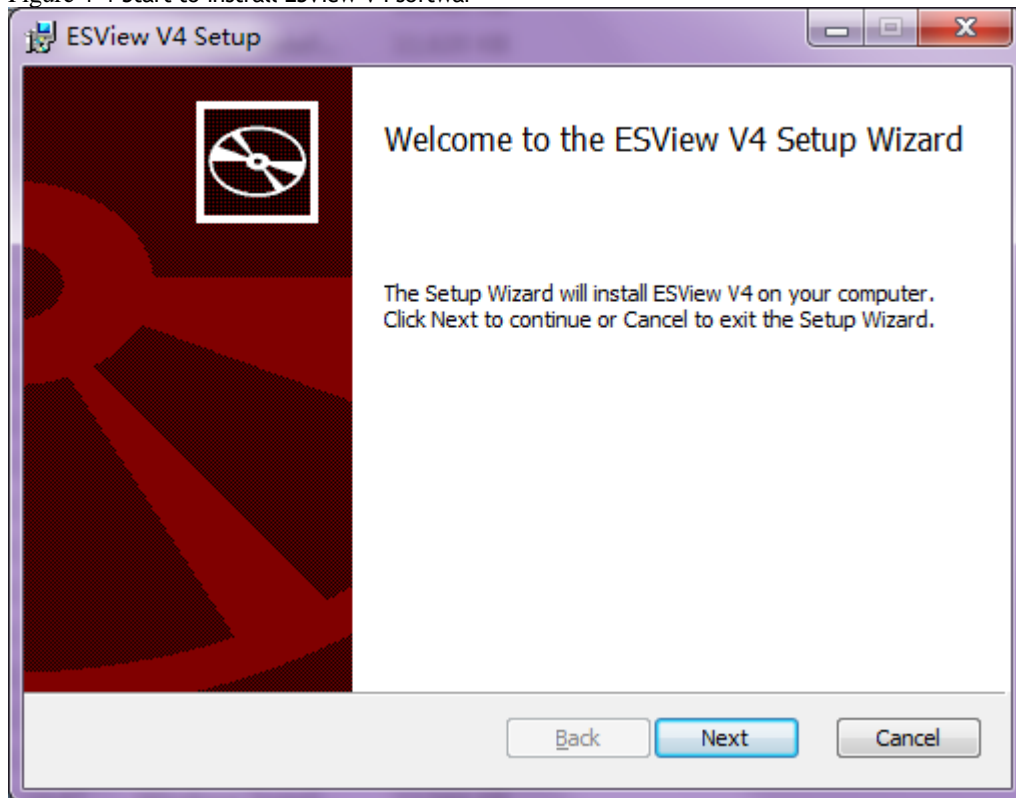

Step 3 Follow the instructions of the installation wizard to install *ESView V4* to your PC.

---- End

Install USB Driver

After installing the ESView V4 software successfully, you may also need to install the USB driver. If you have successfully installed a USB drive, you can skip what is described in this section, otherwise follow the steps below to install the USB driver.



IMPORTANT

Since the USB Driver can only support one designated port, you shall reinstall the USB Driver if you replaced another port on the PC side, or you can use the previous port.

Step 1 After installing the ESView V4 software successfully, connect the Drive to the PC by using the USB connection cable.

Step 2 Open the main directory of ESView V4 software (default location is C:\ESView V4\), and extract the **USB Drivers.rar** compressed file to an appropriate directory of your PC.

Step 3 Open Device Manager.

- For Win7 OS, select **Start > Control Panel**. Click **Device Manager** on the displayed **All Control Panel Items**.
- For Win10 OS, just right-click **Start**, and select **Device Manager** on the pop-up menu.

Step 4 An exclamatory mark attaches to the option **Other devices > ESTUN USB COMM** in **Device Manager** window, which indicates an error occurs in the driver and needs to update.

Figure 4-5 An error occurs in the driver

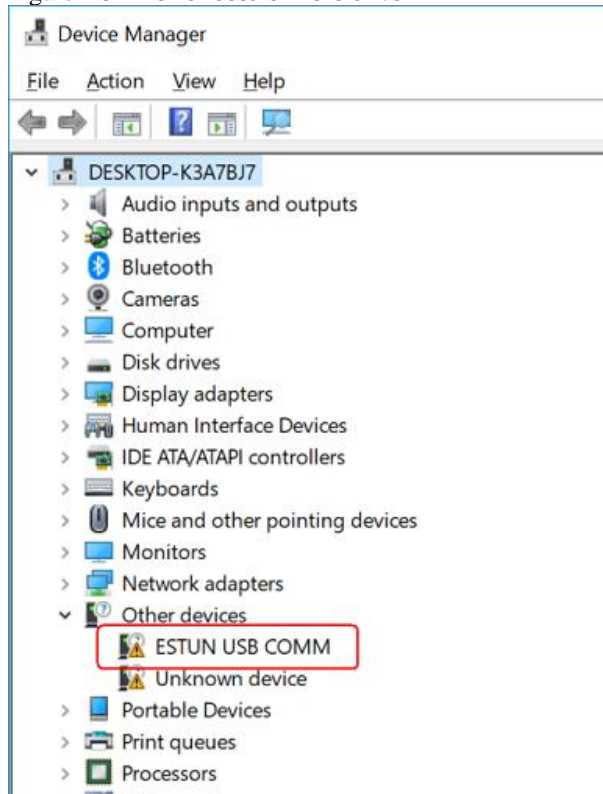

Step 5 Right-click **ESTUN USB COMM**, and select **Update driver** on the pop-up menu.

Figure 4-6 Update driver

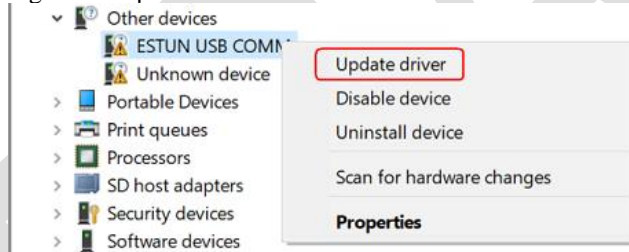

Step 6 Click **Browse my computer for driver software** on the **Update Drivers** dialog box.

Figure 4-7 Browse my computer for driver software

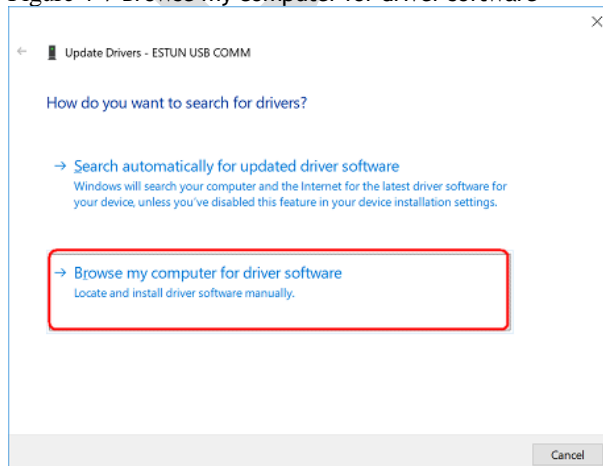

Step 7 Click **Let me pick from a list of available drivers on my computer.**

Figure 4-8 Let me pick from a list of available drivers on my computer

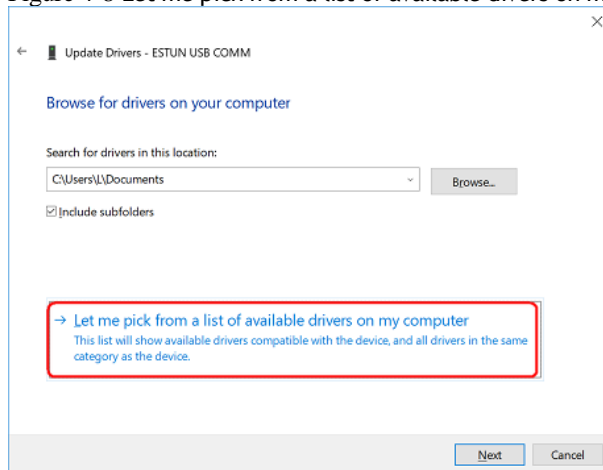

Step 8 Click **Next.**

Figure 4-9 Select your device's type from the list below

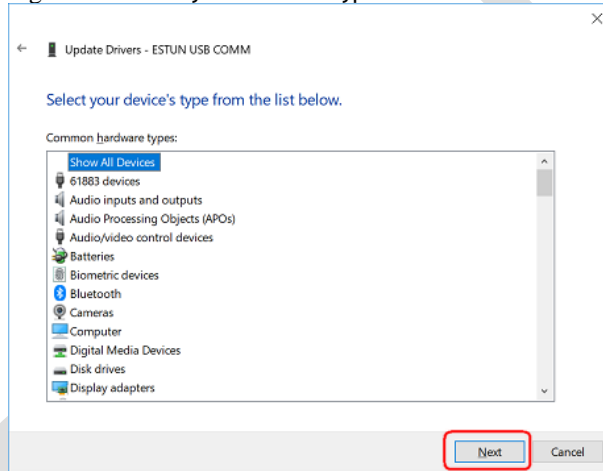

Step 9 Click **Have Disk.**

Figure 4-10 Have Disk

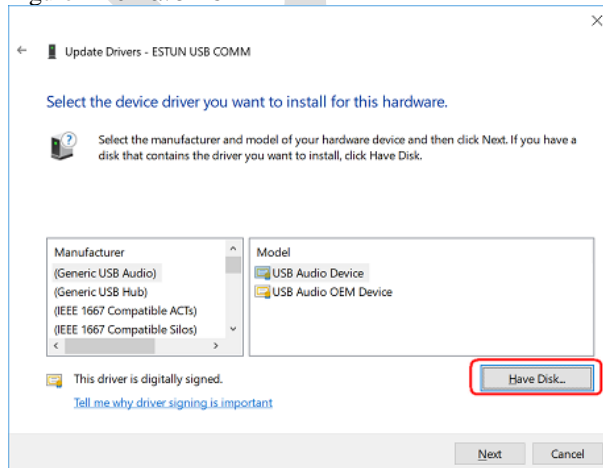

Step 10 Click **Browse** on the **Install From Disk** dialog box.

Figure 4-11 Install From Disk

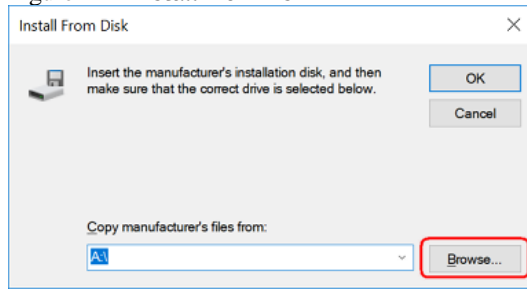

Step 11 Set the **Look in** as the directory of *ESView V4* decompressed file `\USB Drivers\windows_drivers` on the **Locate File** dialog box.

Step 12 Choose `usb_dev_bulk.inf`, and then click **Open**.

Figure 4-12 Choose the driver file

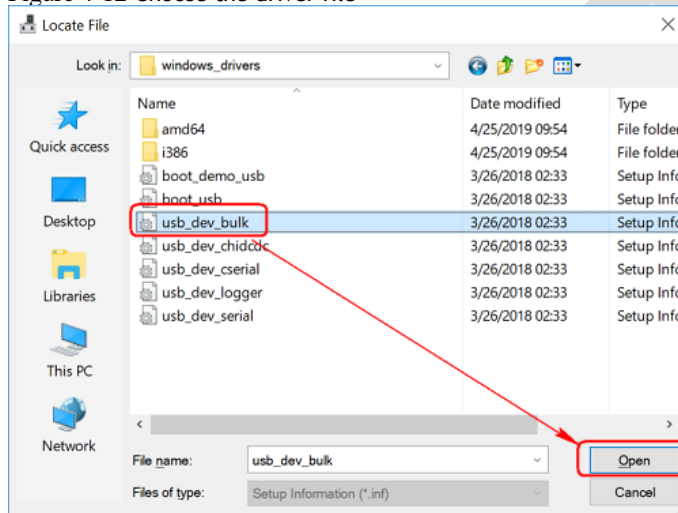

Step 13 Click **OK** on the **Install From Disk** dialog box.

Step 14 Choose **Generic Bulk Device**, and then click **Next**.

Figure 4-13 Select the driver you want to install for this hardware

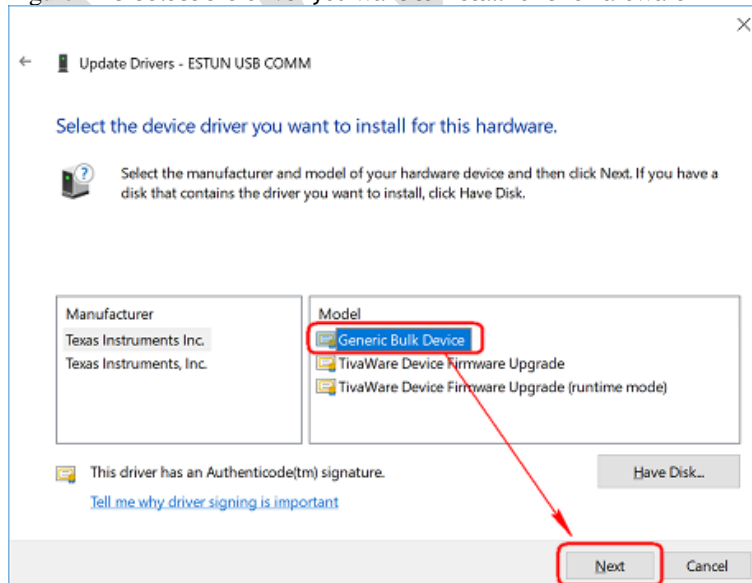

Step 15 Click **Yes** on the **Update Driver Warning** dialog box.

Figure 4-14 Confirm the driver updating

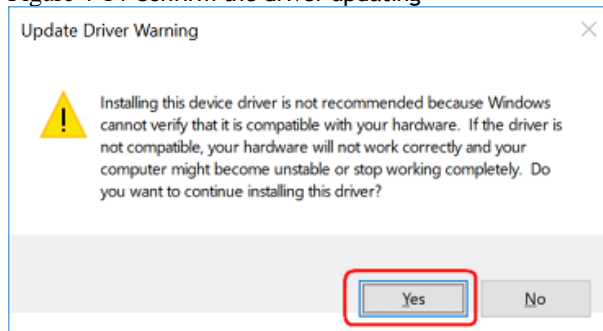

Step 16 Wait for a while, and then click **Install** on the **Windows Security** dialog box.

Figure 4-15 Confirm the installation

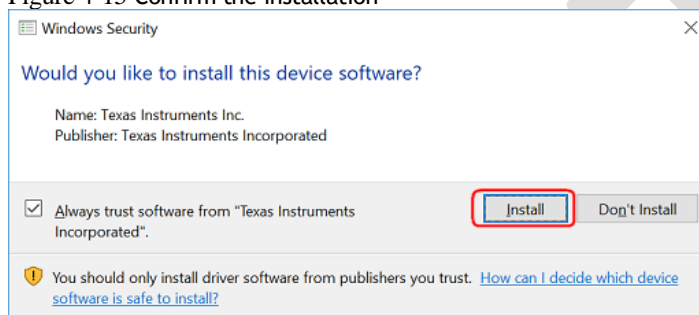

Step 17 The driver will be automatically installed to your PC, and then the installation result will be displayed. Click **Close** to complete the USB driver installation.

Figure 4-16 Complete the USB driver installation

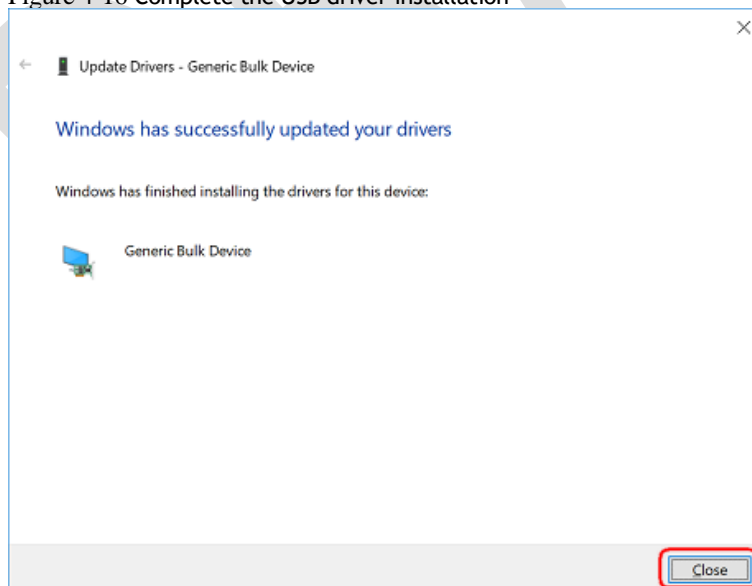

----End

4.2.2 Start EView V4

Online Operation

The parameters only can be written into or read from the Drive under the online operation. It is recommended that you perform an online operation for the first time to set the Drive.

You need to connect the Drive to the PC by using the USB connection cable before the online operation.

Step 1 Connect the Drive to the PC by using the USB connection cable.

Step 2 Select **Programs > EView V4 > EView V4** from the Windows **Start Menu**. Also, you can find and click *EView V4* shortcut on the desktop of Windows.

Step 3 The **Connect** dialog box will be displayed. If you had started *EView V4*, select **Home > Connect** in the **Menu Bar**.

Step 4 Select **USB**.

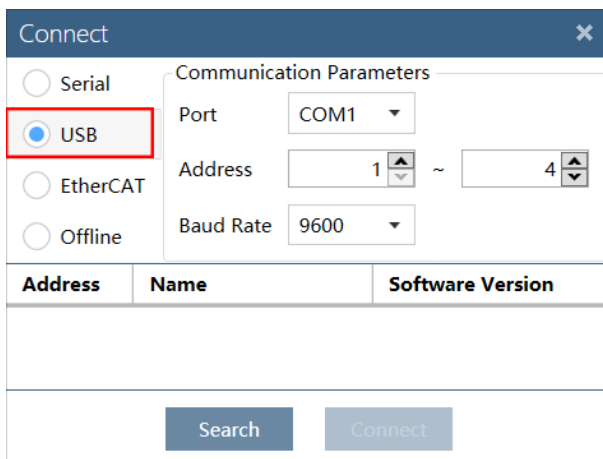

The screenshot shows the 'Connect' dialog box. On the left, there are four radio button options: 'Serial', 'USB', 'EtherCAT', and 'Offline'. The 'USB' option is selected and highlighted with a red box. To the right, under 'Communication Parameters', there is a 'Port' dropdown set to 'COM1', an 'Address' field with a range from 1 to 4, and a 'Baud Rate' dropdown set to '9600'. Below these fields is a table with three columns: 'Address', 'Name', and 'Software Version'. At the bottom of the dialog are two buttons: 'Search' and 'Connect'.

Step 5 Click **Search**.

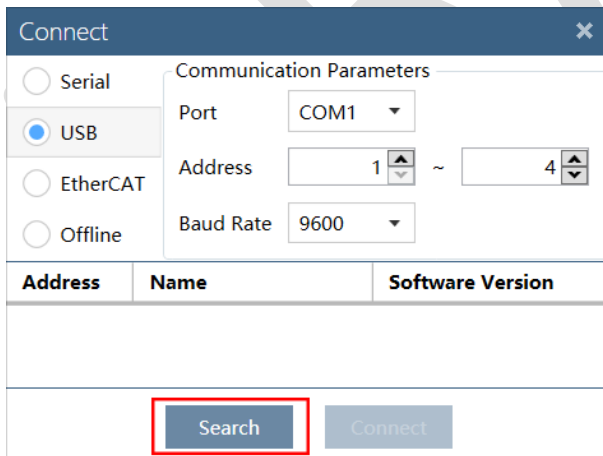

This screenshot is identical to the previous one, but the 'Search' button at the bottom of the dialog is now highlighted with a red box.

Step 6 Select the found device.

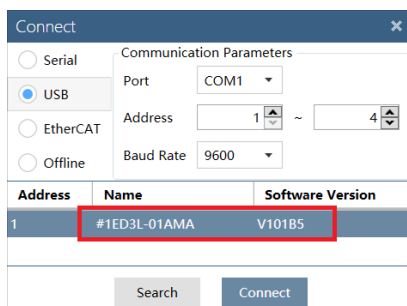

This screenshot shows the 'Connect' dialog box after a search. The table below the communication parameters now contains one row of data. The 'Address' column has the value '1', the 'Name' column has the value '#1ED3L-01AMA', and the 'Software Version' column has the value 'V101B5'. This entire row is highlighted with a red box. The 'Search' button is now disabled (greyed out), and the 'Connect' button is active.

Address	Name	Software Version
1	#1ED3L-01AMA	V101B5

Step 7 Click **Connect**.

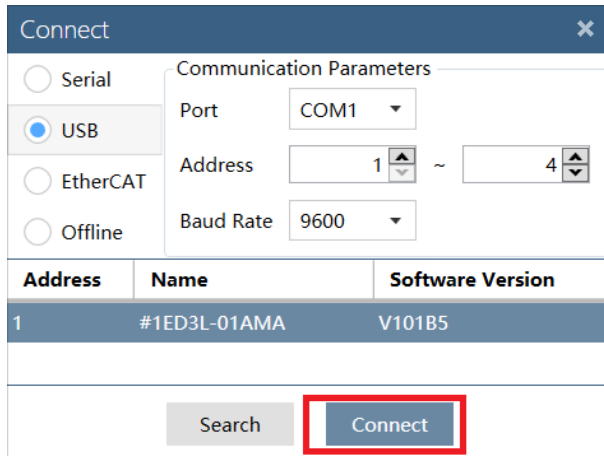

Step 8 The connected device will be displayed in the **Device** list on the left of the *ESView V4* main

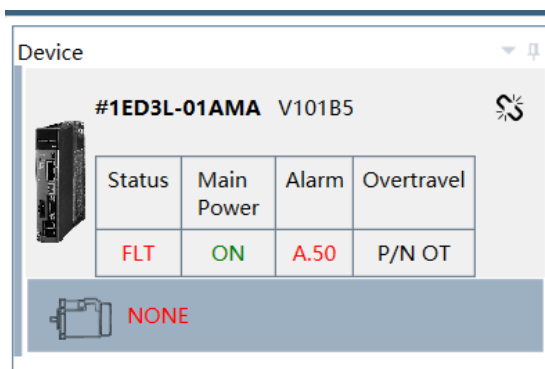

windows.

Now, you can make the necessary settings for the Drive or Motor in real time.

The **Device** list can display all the device you had connected or created (including online and offline), and their basic status.

If you want to delete a device from the **Device** list, click  in the top right, and then click **OK** on the pop-up warning box.

----End

Offline Operation

In offline operation, users do not need to connect any equipment, can perform oscilloscope, FFT, mechanical analysis and other image operations.

Although it is not necessary to connect the actual drive, some functions are limited and cannot be set correctly.

Step 1 Select **Programs** > **ESView V4** > **ESView V4** from the Windows **Start** Menu.
Also, you can find and click *ESView V4* shortcut on the desktop of Windows.

Step 2 The **Connect** dialog box will be displayed.
If you had started *ESView V4*, select **Home** > **Connect** in the **Menu Bar**.

Step 3 Select **Offline**

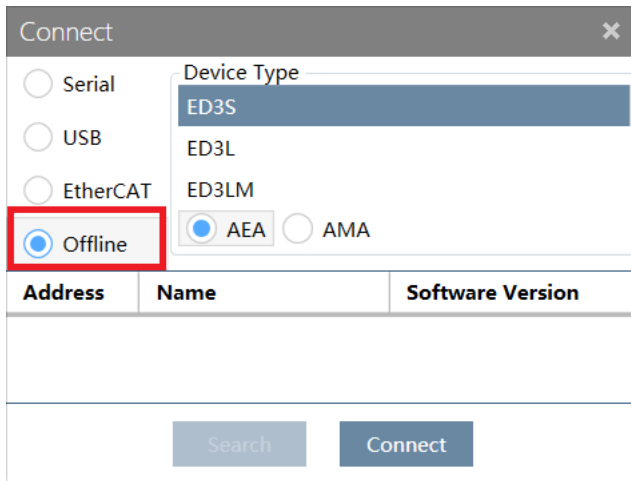

Step 4 Select the desired **Device Type**, e.g. ED3S.

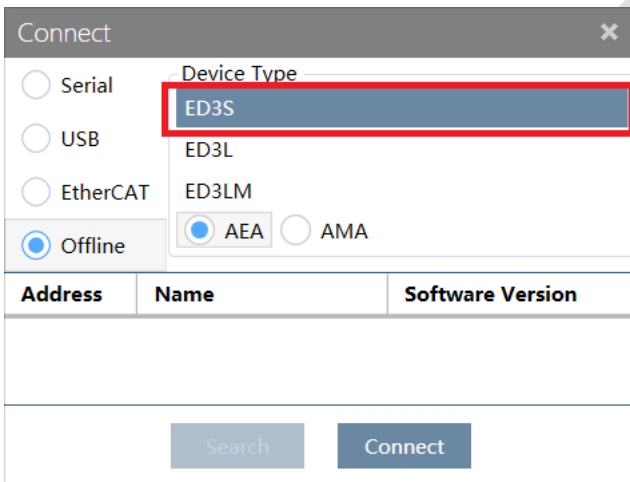

Step 5 Click **Connect**.

Step 6 The created device will be displayed in the **Device** list on the left of the *ESView V4* main windows.

 **NOTE**

Since there is no online connection to a Drive, the functions that you can use are restricted.

----End

4.2.3 Edit Parameters

Follow the below procedure to open the **Edit Parameters** window.

Step 1 Select **Parameters > Edit Parameters** in the **Menu Bar** of the **ESView V4** main windows.

Figure 4-17 Select **Edit Parameters**



Step 2 The Edit Parameters window will be displayed in Function Display Area.

Figure 4-18 **Edit Parameters** window

NO.	Name	Value	Range	Default	Authority(仅Debug)	Address(仅Debug)	Base (Debug Only)	Unit
Function Switch								
Pn 000	Basic Function Selections 0		0000 ~ 0111	0000	Common	496	Binary	
Pn 000.0	Servo ON		0 ~ 1	0	Common	496	Binary	
Pn 000.1	Forward Drive Prohibit Input (P-OT)		0 ~ 1	0	Common	496	Binary	
Pn 000.2	Reverse Drive Prohibit Input (N-OT)		0 ~ 1	0	Common	496	Binary	
Pn 000.3	Reserved parameter (Do not change.)		0 ~ 0	0	Common	496	Binary	
Pn 001	Basic Function Selections 1		0000 ~ 0001	0000	Common	498	Binary	
Pn 001.0	CCW, CW		0 ~ 1	0	Common	498	Binary	
Pn 001.1	Reserved parameter (Do not change.)		0 ~ 0	0	Common	498	Binary	
Pn 001.2	Reserved parameter (Do not change.)		0 ~ 0	0	Common	498	Binary	
Pn 001.3	Reserved parameter (Do not change.)		0 ~ 0	0	Common	498	Binary	
Pn 002	Application Function Selections 2		0000 ~ 0100	0000	Common	500	Binary	
Pn 002.0	Reserved parameter (Do not change.)		0 ~ 0	0	Common	500	Binary	
Pn 002.1	Reserved parameter (Do not change.)		0 ~ 0	0	Common	500	Binary	
Pn 002.2	Encoder Usage		0 ~ 1	0	Common	500	Binary	
Pn 002.3	Reserved parameter (Do not change.)		0 ~ 0	0	Common	500	Binary	

Upload Parameters

- Upload All

In order to read all parameters from the Drive and fill them into **Value** column of the parameters list, you can:

- Click **Upload All** in the **Edit Parameters** window

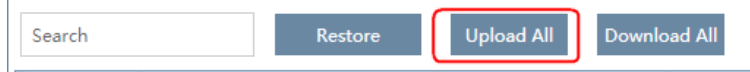

- Right-click the parameters list where cannot be edited, and select **Upload All** in the pop-up menu.

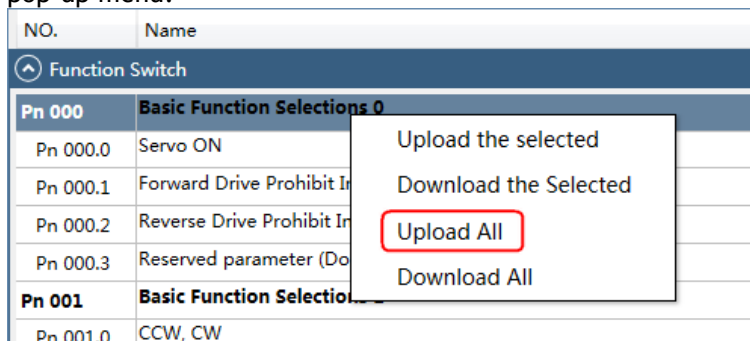

- Upload the Selected

Drag the mouse to select the desired parameters, or you can hold **Ctrl** key and click the desired parameter, and then right-click a selected parameter, and select **Upload the selected** in the pop-up menu.

NO.	Name
Function Switch	
Pn 000	Basic Function Selections 0
Pn 000.0	Servo ON
Pn 000.1	Forward Drive Prohibit Input (P-OT)
Pn 000.2	Reverse Drive Prohibit Input (N-OT)
Pn 000.3	Reserved parameter (Do not change.)
Pn 001	Basic Function Selections 1
Pn 001.0	CCW, CW
Pn 001.1	Reserved parameter (Do not change)
Pn 001.2	Reserved parameter (Do not change)
Pn 001.3	Reserved parameter (Do not change)
Pn 002	Application Function Selections 2

Upload the selected

Download the Selected

Upload All

Download All



You can only fulfill the **Upload Parameter** function in **Online operation**. If a warning dialog box **Unable to upload the parameters** is displayed, check the connection between PC and the Drive.

Modify Parameters

When the parameters have been uploaded from the device, you can modify them on the **Value** column. If a value has been modified, the background of the textbox can be changed, as shown in Figure 4-19.

Figure 4-19 Display after editing parameters

Function Switch		Value	Range
Pn 000	Basic Function Selections 0	0100	0000 ~ 0111
Pn 000.0	Servo ON	0	0 ~ 1
Pn 000.1	Forward Drive Prohibit Input (P-OT)	0	0 ~ 1
Pn 000.2	Reverse Drive Prohibit Input (N-OT)	1	0 ~ 1
Pn 000.3	Reserved parameter (Do not change.)	0	0 ~ 0
Pn 001	Basic Function Selections 1	0001	0000 ~ 0001
Pn 001.0	CCW, CW	1	0 ~ 1

You can refer to the description displayed on the underside of the parameter list for the parameter modification.

Figure 4-20 Details description of the parameter

NO.	Name	Value	Range
Function Switch			
Pn 000	Basic Function Selections 0	0100	0000 ~ 0111
Pn 000.0	Servo ON	0	0 ~ 1
Pn 000.1	Forward Drive Prohibit Input (P-OT)	0	0 ~ 1
Pn 000.2	Reverse Drive Prohibit Input (N-OT)	1	0 ~ 1
Pn 000.3	Reserved parameter (Do not change.)	0	0 ~ 0
Pn 001	Basic Function Selections 1	0001	0000 ~ 0001
Pn 001.0	CCW, CW	1	0 ~ 1
Pn 001.1	Reserved parameter (Do not change.)	0	0 ~ 0
Pn 001.2	Reserved parameter (Do not change.)	0	0 ~ 0
Pn 001.3	Reserved parameter (Do not change.)	0	0 ~ 0
Pn 002	Application Function Selections 2	0100	0000 ~ 0100
Pn 002.0	Reserved parameter (Do not change.)	0	0 ~ 0
Pn 002.1	Reserved parameter (Do not change.)	0	0 ~ 0
Pn 002.2	Encoder Usage	1	0 ~ 1
Pn 002.3	Reserved parameter (Do not change.)	0	0 ~ 0
Pn 003	Application Function Selections 3	0000	0000 ~ 1032

Pn000.2 Reverse Drive Prohibit Input (N-OT)
 [0] Enabled. The motor is stopped according to the setting of Pn003.1 when the overtravel occurs.
 [1] Disabled.

 **NOTE**

Click **Search** input box on the **Edit Parameters** window, and type the keyword you want to search. The keyword, including **NO, Name, Value, Range, Default, Unit**, as well as description of each parameter.

If you want to search multiple items at once, add one or more space between keywords that lists all the parameters that match any of the keywords.

Save Parameters

Follow the below procedure to save the current settings as an offline file into the PC.

Step 1 Click  in the **Edit Parameters** window.

Figure 4-21 Save the parameters

Name	Value	Range	Default	Authority(仅Debug)	Address(仅Debug)	Base (Debug Only)	Unit
Motor Stopping Methods for Servo OFF, STO, and Gr.1 Alarms	0	0 ~ 2	0	Common	502	Hex	
Overtravel Stopping Method	0	0 ~ 3	0	Common	502	Hex	
Reserved parameter (Do not change.)	0	0 ~ 0	0	Common	502	Hex	

Step 2 Choose the desired files in the **Save As** dialog box.

Step 3 Click **Save**.

----End

Import Parameters

You can fulfill Import function, importing the offline parameters file into the online Drive.

Step 1 Select **Parameters > Import** in the **Menu Bar** of the EView V4 main windows.

Figure 4-22 Select Import

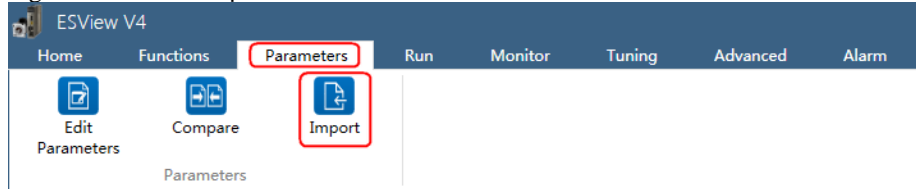

Step 2 Select a proper offline parameter file (*.esvpa) in the pop-up **Open** dialog box.

Step 3 The **Import** window will be displayed in **Function Display Area**.

And, the **Local Value** in the offline parameters file are filled into the parameter list.

Figure 4-23 Local Value displayed in Import window

The screenshot shows the 'Import' window in ESView V4. At the top, there is a search bar and a 'Download All' button. To the right, there are checkboxes for 'Difference Only' (unchecked) and 'Sub-parameters' (checked). Below this is a table with the following columns: NO., Name, Local Value, Range, Default, and Unit. The 'Local Value' column is highlighted with a red box. Below the table, there is a text area with the message: 'Pn000 Basic Function Selections 0 Validate After Restart'.

NO.	Name	Local Value	Range	Default	Unit
Pn 000	Basic Function Selections 0	0000	0000 ~ 0111	0000	
Pn 000.0	Servo ON	0	0 ~ 1	0	
Pn 000.1	Forward Drive Prohibit Input (P-OT)	0	0 ~ 1	0	
Pn 000.2	Reverse Drive Prohibit Input (N-OT)	0	0 ~ 1	0	
Pn 000.3	Reserved parameter (Do not change.)	0	0 ~ 0	0	
Pn 001	Basic Function Selections 1	0000	0000 ~ 0001	0000	
Pn 001.0	CCW, CW	0	0 ~ 1	0	
Pn 001.1	Reserved parameter (Do not change.)	0	0 ~ 0	0	
Pn 001.2	Reserved parameter (Do not change.)	0	0 ~ 0	0	
Pn 001.3	Reserved parameter (Do not change.)	0	0 ~ 0	0	
Pn 002	Application Function Selections 2	0100	0000 ~ 0100	0000	
Pn 002.0	Reserved parameter (Do not change.)	0	0 ~ 0	0	
Pn 002.1	Reserved parameter (Do not change.)	0	0 ~ 0	0	
Pn 002.2	Encoder Usage	1	0 ~ 1	0	
Pn 002.3	Reserved parameter (Do not change.)	0	0 ~ 0	0	
Pn 003	Application Function Selections 3	0000	0000 ~ 1032	0000	

Pn000 Basic Function Selections 0 Validate After Restart

Step 4 在 Before importing parameters into the Drive, you can edit and download the parameters.

----End

Download Parameters

- Download All
- In order to write all parameters of the parameters list into the Drive, you can:
 - Click Download All in the Edit Parameters window.

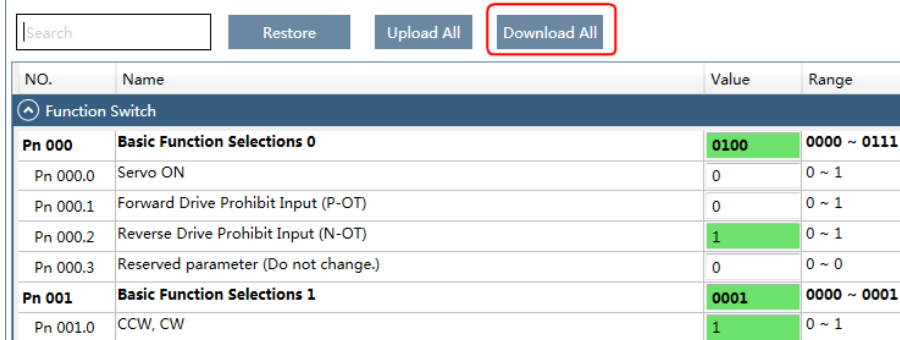

NO.	Name	Value	Range
Function Switch			
Pn 000	Basic Function Selections 0	0100	0000 ~ 0111
Pn 000.0	Servo ON	0	0 ~ 1
Pn 000.1	Forward Drive Prohibit Input (P-OT)	0	0 ~ 1
Pn 000.2	Reverse Drive Prohibit Input (N-OT)	1	0 ~ 1
Pn 000.3	Reserved parameter (Do not change.)	0	0 ~ 0
Pn 001	Basic Function Selections 1	0001	0000 ~ 0001
Pn 001.0	CCW, CW	1	0 ~ 1

- Right-click the parameters list where cannot be edited, and select **Download All** in the pop-up menu.

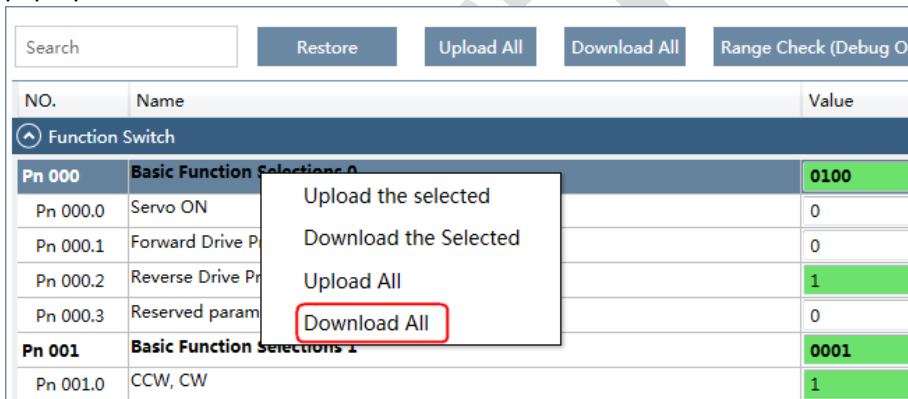

NO.	Name	Value
Function Switch		
Pn 000	Basic Function Selections 0	0100
Pn 000.0	Servo ON	0
Pn 000.1	Forward Drive P	0
Pn 000.2	Reverse Drive Pr	1
Pn 000.3	Reserved param	0
Pn 001	Basic Function Selections 1	0001
Pn 001.0	CCW, CW	1

- Download the Selected

Drag the mouse to select the desired parameters, or you can hold **Ctrl** key and click the desired parameter, and then right-click a selected parameter, and select **Download the Selected** in the pop-up menu.

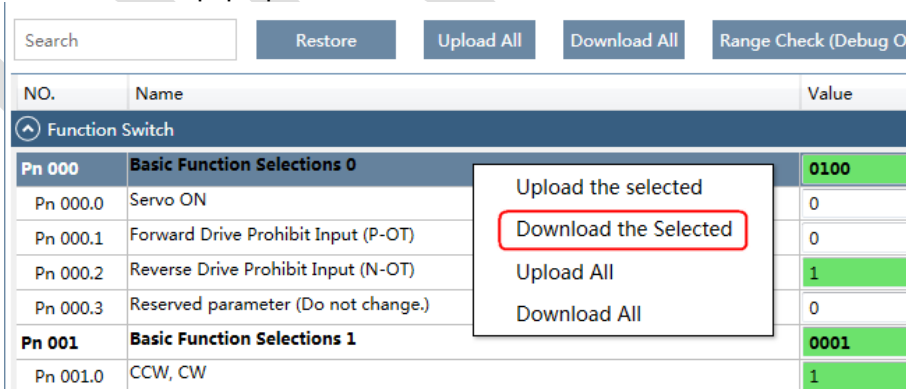

NO.	Name	Value
Function Switch		
Pn 000	Basic Function Selections 0	0100
Pn 000.0	Servo ON	0
Pn 000.1	Forward Drive Prohibit Input (P-OT)	0
Pn 000.2	Reverse Drive Prohibit Input (N-OT)	1
Pn 000.3	Reserved parameter (Do not change.)	0
Pn 001	Basic Function Selections 1	0001
Pn 001.0	CCW, CW	1



You can only fulfill the Download Parameter function in **Online Operation**. If a warning dialog box **Unable to download the parameters** is displayed, check the connection between PC and the Drive.

Restore Parameters



Make sure that it is necessary to restore the parameters as default setting before fulfilling the **Restore Parameters** function.

Step 1 Click **Restore** in the **Edit Parameters** window.

Figure 4-24 Restore parameters

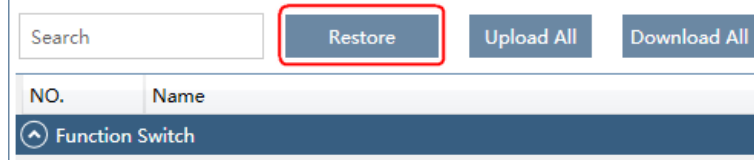

Step 2 Read the content on the warning dialog box and click **OK**.

Figure 4-25 Confirm the parameter restpred

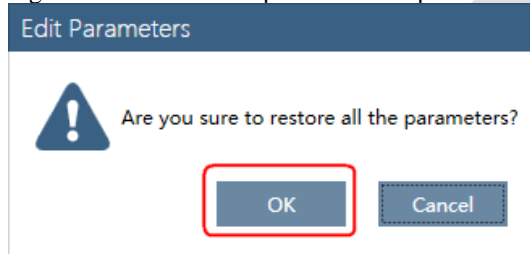

Step 3 ESView V4 will send the **Restore Parameters** command to the Drive, and then the Drive will execute the **Restore Parameters**.

----End

4.2.4 Monitor

Device Status

The **Device** list can display all the device you had connected or created (including online and offline), and their basic status.

The blue side indicates this device is under performing.

Status	Main Power	Alarm	Overtravel
RDY	ON	—	—

This drive is an online device.

Here shows the status of the device.

This shows the motor to which the drive is connected

This drive is an offline device.

IO Monitor

Use the **Monitor** function for displaying the main parameters of the device and the I/O signal information.

Step 1 在 **Select Monitor > Monitor** in the **Menu Bar** of the *ESView V4* main windows.

Figure 4-26 Select Monitor



NOTE

You can also move the cursor upon **Monitor** on the right side of the main window of *ESView V4* and stay for a while, the **Monitor List** will be displayed.

Step 2 The **Monitor List** will display the information of **DATA MONITOR** and **I/O MONITOR**.

Figure 4-27 Monitor List

DATA MONITOR		
Name	Value	Unit
Speed Feedback	0	r/min
Internal Torque Reference	0	%
Rotation Pulses	364883	1Pulse
Setting Pulse Counter	70232817	1Pulse
Encoder Multi-turn	8	
Encoder Single-turn	2042604	
Load Inertia Percentage	0	%
Overload Ratio	0	%
Present Location	0	1Pulse
Error Pulse Counter	0	1Pulse
TP2	0	
TP1	0	
Second Encoder A	0	
Second Encoder B	0	
Second Encoder C	0	
STO HWBB2	1	
STO HWBB1	1	
Busbar Voltage	313	V
Encoder Temperature	33	°C
Power Plate Temperature	33	°C
External Feedback Count	0	

I/O MONITOR	
Name	Unit
Input Signal State	
CN1_14	0
CN1_15	0
CN1_16	0
CN1_17	0
CN1_18	0
Output Signal State	
CN1_06/07	0
CN1_08/09	1

Chapter 5 Application Functions

5.1 Power Supply

The main circuit and control circuit of the Drive can be operated with AC power input. When AC power input is selected, single- phase or three phase power input can be used. You shall to set the parameter Pn007.1 and Pn007.3 (use AC power input) according to the applicable power supply.

Parameter	Setting	Meaning	When Enabled
Pn007.1	0	Use a single-phase AC power supply.	After restart
	1	Use a three-phase AC power supply. NOTE: This setting is invalid for the Drive power from 50W to 400W.	
	2	AC power supply frequency is 50Hz.	
Pn007.3	0	AC power supply frequency is 60Hz.	
	1	Use a single-phase AC power supply.	

An alarm A.24 (Main Circuit Power Supply Wiring Error) may be occurred if the setting of Pn007.1 be consonant with not match the applicable power supply.



warn

- When using AC power supply and DC power supply to connect to the driver, please make a terminal connection. Ac power supply should be connected to the L1/L2/L3 terminals and L1C/L2C terminals of the driver.
- DC power supply should be connected to the B1/decile terminal and one terminal and L1C/L2C terminal of the driver.
- Before using the DC power input, please be sure to set Pn007.1=2 before entering the main loop to avoid burning the internal components of the driver.
- When the DC power supply is input, set the fuse on the power supply wiring.
- No regeneration is performed when using the DC power input, so please perform regenerative energy treatment on the power supply side.

5.2 Motor Rotation Direction

You can reverse the direction of Motor rotation by changing the setting of Pn001.0.

The default setting for Forward Rotation is counterclockwise (CCW) as viewed from the Drive end.

Parameter	Setting	Reference	Diagram
Pn001.0	0: CCW	Forward Reference	
		Reverse Reference	
	1: CW	Forward Reference	
		Reverse Reference	

5.3 Overtravel Limit

5.3.1 Function Description

Overtravel is a safety function of the Drive that forces the Motor to stop in response to a signal input from a limit switch that is activated when a moving part of the machine exceeds the safe range of movement.

The overtravel signals include the P-OT (Forward Drive Prohibit) and the N-OT (Reverse Drive Prohibit) signals.

You use the P-OT and N-OT signals to stop the machine by installing limit switches at the positions where you want to stop the machine that is operated by the Motor.

An example of wiring for the P-OT signal and the N-OT signal is shown in Figure 5-1.

Figure 5-1 Wiring diagram for the overtravel

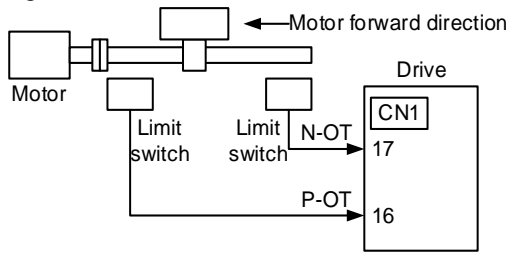

Using the overtravel function is not necessary for rotating applications such as rotary tables and conveyors. No wiring for overtravel input signals is required.



CAUTION

- To prevent accidents that may result from contact faults or disconnections, use normally closed limit switches. Moreover, never change the default settings of the polarity of the overtravel signals (P-OT and N-OT).
- When using the Motor on a vertical axis, the workpiece may fall in the overtravel condition. To prevent this, always set the zero clamp after stopping with Pn003.1=2.

5.3.2 Connecting the Overtravel Signal

To use the overtravel function, connect the following overtravel limit switch input signal terminals.

Type	Name	Pin	Setting	Meaning
Input	P-OT	CN1-16	ON	Forward run allowed. Normal operation status.
			OFF	Forward run prohibited. Forward overtravel.
	N-OT	CN1-17	ON	Reverse run allowed. Normal operation status.
			OFF	Reverse run prohibited. Reverse overtravel.

5.3.3 Enabling/Disabling the Overtravel Signal

Parameters can be set to disable the overtravel signal. If the parameters are set, there is no need to wire the overtravel input signal.

Parameter	Setting	Meaning	When Enabled
Pn000.1	0 [Default]	Inputs the Forward Drive Prohibited (P-OT) signal from CN1-16. [Default]	After restart
	1	Disables the Forward Drive Prohibited (P-OT) signal. (Always allow forward rotation)	
Pn000.2	0 [Default]	Inputs the Reverse Drive Prohibited (N-OT) signal from CN1-15. [Default]	

Parameter	Setting	Meaning	When Enabled
	1	Disables the Reverse Drive Prohibited (N-OT) signal. (Always allow reverse rotation)	

In addition, you can disable the overtravel limit function by not set the values 1 and 2 to parameter Pn509 (not allocate the P-OT signal and N-OT signal).

5.4 Motor Stopping Methods

Following 4 ways are available to stop the drive alarming (Gr.1 or Gr.2), OT state, and servo OFF occurs:

Stop method	Meaning
Stopping by dynamic brake	The electric circuits are internally connected to stop the Motor quickly.
Coasting to a stop	The Motor stops naturally due to friction during operation.
Reverse brake	Emergency stop torque is used to decelerate the Motor to a stop.
Do not stop	Regards Alarms as the Warnings, and the Motor will not be stopped.

Also, you can let the Motor enter the following states after the Motor stops.

State after Stopping	Meaning
Coasting	The Drive does not control the Motor (The machine will move in response to a force from the load).
Dynamic Brake (DB)	The electric circuits are internally connected to hold the Motor.
Zero clamping	A position loop is created and the Motor remains stopped at a position reference of 0. (The current stop position is held.)
Operation	The state in which the Drive continues to control the Motor.

5.4.1 Motor Stop Methods for Gr.1 Alarms, Safety State and Servo OFF

You can select the Motor stopping methods for Gr.1 Alarms occur, in Safe state or Servo OFF by setting the parameter Pn003.0.

Parameter	Setting	Stop Method	After Stopping	When Enabled
Pn003.0	0[Default]	Stopping by dynamic brake	Coasting	After restart
	1	Stopping by dynamic brake	Dynamic Brake	
	2	Coasting to a stop	Coasting	

5.4.2 Motor Stop Methods for Overtravel

You can select the Motor stopping methods for overtravel occurs by setting the parameter Pn003.1.

Parameter	Setting	Stop Method	After Stopping	When Enabled
Pn003.1	0 [Default]	Stopping by dynamic brake	Coasting	After restart
	1	Inertial running stops	Coasting	
	2	Reverse brake	Zero clamping	
	3	Reverse brake	Coasting	

NOTE: The speed reference is set to 0 during the reverse brake, so that the soft stat function is unavailable. In addition, you shall set a reverse brake torque for stopping the Motor (Pn405).

5.4.3 Motor Stop Methods for Gr.2 Alarms

You can select the Motor stopping methods for Gr.2 Alarms occur by setting the parameter Pn004.0.

Parameter	Setting	Stop Method	After Stopping	When Enabled
Pn004.0	0 [Default]	Stop by dynamic brake	Coasting	After restart
	1	Stop by dynamic brake	Dynamic Brake	
	2	Coast to a stop	Coast	
	3	Reverse brake	Dynamic Brake	
	4	Reverse brake	Coast	
	5	Do not stop, regard as a warning	Operation	

5.4.4 Reverse Brake Torque Limit Setting

If Pn004.0 is set to 3 or 4, the Motor will be decelerated to a stop using the torque set in Pn405 as the maximum torque.

Parameter	Name	Range	Unit	Default	When Enabled
Pn405	Reverse Brake Torque Limit	0 to 350	1%	300	Immediately

 NOTE

- This setting is a percentage of the rated torque.
- The default setting is 300%. This setting is large enough to allow you to operate the Motor at the maximum torque. However, the maximum stop torque that you can actually use is the maximum torque of the Motor.

5.5 Holding Brake

5.5.1 Function Description

A holding brake is used to hold the position of the moving part of the machine when the Drive is turned OFF so that moving part does not move due to gravity or an external force.

You can use the brake that is built into a Motor with a Brake, or you can provide one on the machine.

The holding brake is used in the following cases.

Figure 5-2 The used of holding brake

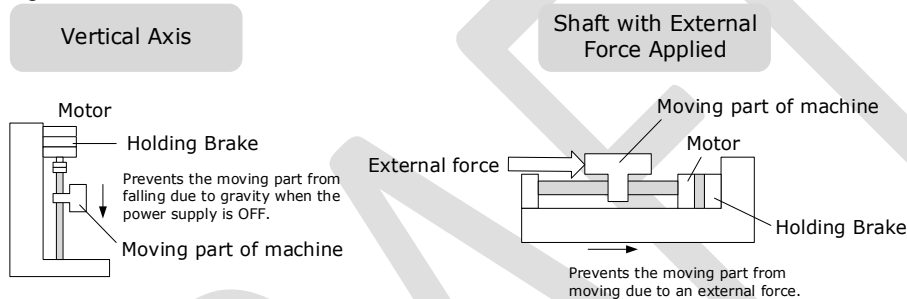

IMPORTANT

The brake built into a Motor with a Brake is a de-energization brake. It is used only to hold the Motor and cannot be used for braking. Use the holding brake only to hold a Motor that is already stopped.

5.5.2 Brake Operating Sequence

You must consider the time required to release the brake and the time required to brake to determine the brake operation timing, as described below.

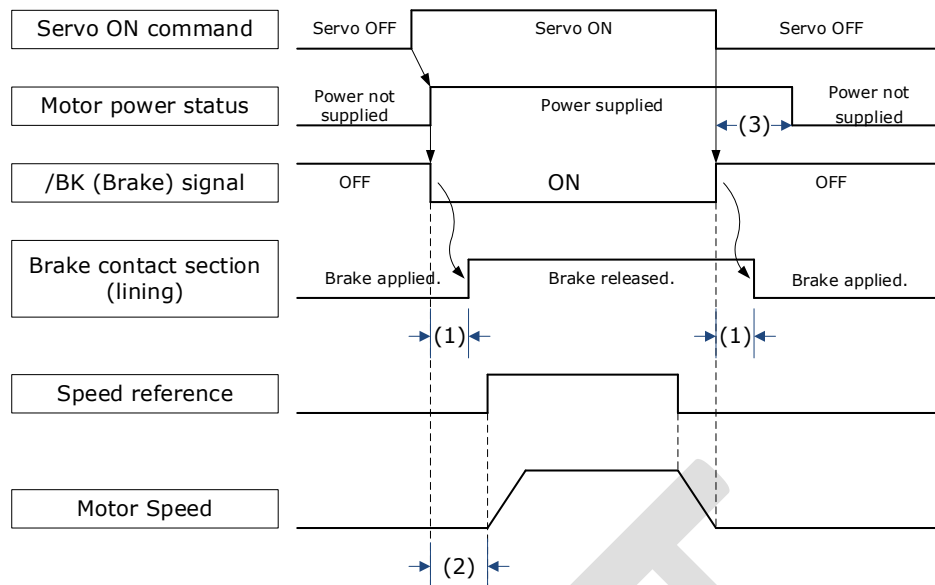

(1): The brake delay times for Motors with Holding Brakes.

(2): Before you output a reference from the host controller to the Drive, wait for at least 50 ms plus the time required to release the brake after you send the S-ON command.

(3): Use Pn506 (Servo OFF Waiting Time), Pn507 (Brake Enable Speed Threshold), and Pn508 (Brake Enable Waiting Time) to set the timing of when the brake will operate and when the servo will be turned OFF.

NOTE

- Time Required to Release Brake: The time from when the /BK (Brake) signal is turned ON until the brake is actually released.
- Time Required to Brake: The time from when the /BK (Brake) signal is turned OFF until the brake actually operates.

Table 5-1 抱闸参数表

Motor model	Voltage [VDC]	Braking torque [N·m]	Field current [Arms]	Brake action time [ms]	Brake opening time [ms]	power [W]	Coil resistance [Ω]	Back lash [$^{\circ}$]
EM3A-A5A EM3A-01A	24V \pm 10%	≥ 0.32		40	20	4		
EM3A-02A EM3A-04A	24V \pm 10%	≥ 1.5		25	50	7.4		
EM3A-08A EM3A-10A	24V \pm 10%							
EM3A-15A EM3A-20A	24V \pm 10%							
EM3G-09A EM3G-13A	24V \pm 10%	≥ 20		40	100	23		
EMG-10A EMG-15A EMG-20A	24V \pm 10%							

5.5.3 /BK (Brake) Signal

The /BK signal is turned OFF (to operate the brake) when the Servo is turned OFF or when an alarm is detected. You can adjust the timing of brake operation (i.e., the timing of turning OFF the /BK signal) with the Servo OFF Waiting time (Pn506).

Type	Signal	Pin	Signal Status	Meaning
Output	/BK	Allocated by Pn511	ON	Releases the brake.
			OFF	Activates the brake.

The /BK signal is not allocated in default setting, set its allocation in Pn511.

Parameter	Setting	+ Pin	- Pin	Meaning
Pn511.0	4	CN1-11	CN1-12	The /BK signal is output from output terminal CN1-11 and CN1-12.
Pn511.1	4	CN1-5	CN1-6	The /BK signal is output from output terminal CN1-5 and CN1-6.
Pn511.2	4	CN1-9	CN1-10	The /BK signal is output from output terminal CN1-9 and CN1-10.

5.5.4 Output Timing of /BK Signal when Motor is Stopped

When the Motor is stopped, the /BK signal turns OFF as soon as the S-OFF (Servo OFF) command is received. Use the servo OFF delay time (Pn506) to change the timing to turn OFF power supply to the Motor after the S-OFF command is input.

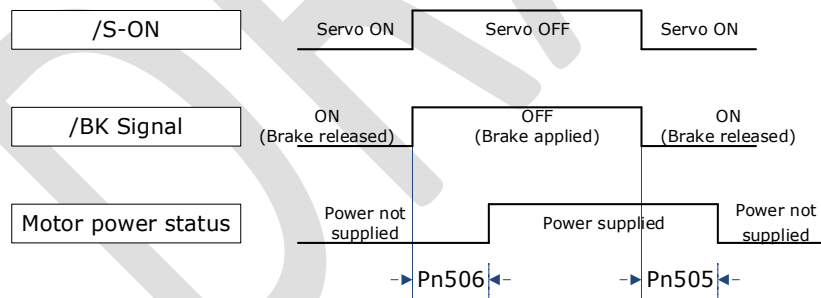

Parameter	Name	Range	Unit	Default	When Enabled
Pn505	Servo ON Waiting Time	-2000 to 2000	ms	0	Immediately
Pn506	Servo OFF Waiting Time	0 to 500	10ms	0	Immediately

 NOTE

- Set Pn505 as a positive value, when S-ON command is received, the /BK signal will be output first, and then power supplied to the Motor after waiting for this setting.
- Set Pn505 as a negative value, when S-ON command is received, power supplied to the Motor immediately, and then output the /BK signal after waiting for this setting.

When the Motor is used to control a vertical axis, the machine moving part may move slightly due to gravity or an external force.

You can eliminate this slight motion by setting the servo OFF delay time (Pn506) so that power supply to the Motor is stopped after the brake is applied.



IMPORTANT

Power supply to the Motor will be stopped immediately when an alarm occurs, regardless of the setting of this parameter. The machine moving part may move due to gravity or an external force before the brake is applied.

5.5.5 Output Timing of /BK Signal when Motor is operating

If an alarm occurs or S-OFF command is received while the Motor is operating, the Motor will start stopping and the /BK signal will be turned OFF. You can adjust the timing of /BK signal output by setting the Brake Enable Waiting Time (Pn508).

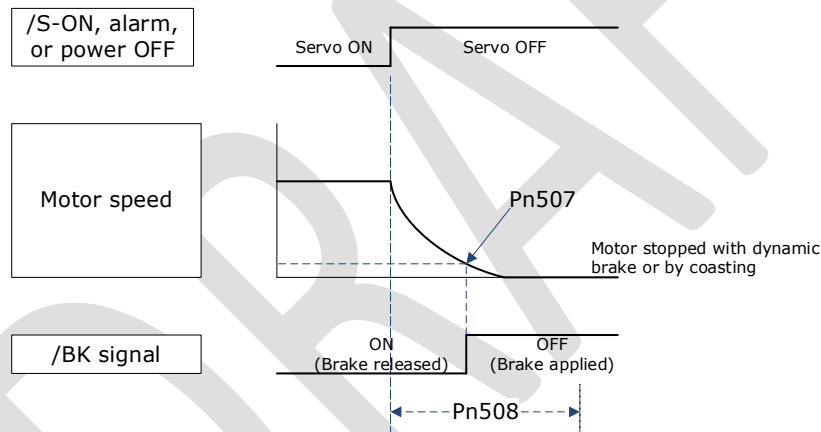

The /BK signal goes to H level (brake ON) when either of the following conditions is satisfied:

- When the Motor speed falls below the level set in Pn507 after the power to the Motor is turned OFF.
- When the time set in Pn508 is exceeded after the power to the Motor is turned OFF.

Parameter	Name	Range	Unit	Default	When Enabled
Pn507	Brake Enable Speed Threshold	10 to 100	1rpm	100	Immediately
Pn508	Brake Enable Waiting Time	10 to 100	10ms	50	Immediately

5.6 Encoder Settings

5.6.1 Absolute Encoder Selection

Absolute encoders are fitted on motors with an encoder type of L; e.g. EM3A-02ALA211. These encoders require a battery supply to retain the absolute encoder data when the Drive power is removed.

With a system that uses an absolute encoder, the host controller can monitor the current position. Therefore, it is not necessary to perform an origin return operation when the power supply to the system is turned ON.

There are two types of encoders for the Motors. The usage of the encoder is specified in Pn002.2.

Parameter	Setting	Meaning	When Enabled
Pn002.2	0 [Default]	Use the encoder as an absolute encoder.	After restart
	1	Use the encoder as an incremental encoder.	



IMPORTANT

The default setting of the Drive uses an absolute encoder. If the Motor encoder is an incremental encoder, an A47 alarm or an A48 alarm will occur when the Drive is first powered up.

In this case, set Pn002.2=1 and restart the Drive.

5.6.2 Encoder Alarm Resetting

If alarm A.47 or A.48 occurs, replace the battery as soon as possible. After replacing the battery, perform the operation **Absolute encoder alarm reset** and **Fn010 (Absolute encoder multi-turn reset)**.

For details about how to replace a battery and how to perform the replacement, see 3.5.4 Installing or Replacing a Battery.

5.6.3 Multiturn Limit Setting

The multiturn limit is used in position control for a turntable or other rotating body.

For example, consider a machine that moves the turntable shown in the following diagram in only one direction.

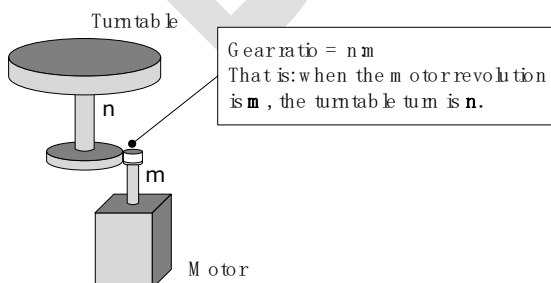

Because the turntable moves in only one direction, the upper limit to the number of revolutions that can be counted by an absolute encoder will eventually be exceeded.

The multiturn limit is used in cases like this to prevent fractions from being produced by the integral ratio of the number motor revolutions and the number of turntable revolutions.

For a machine with a gear ratio of $n:m$, as shown above, you can set Pn228 (OB 30A9h in EtherCAT) as m , and the value of $m - 1$ will be the setting for the multiturn limit setting.

The relationship between the number of turntable revolutions and the number of motor revolutions is shown in the following figure.

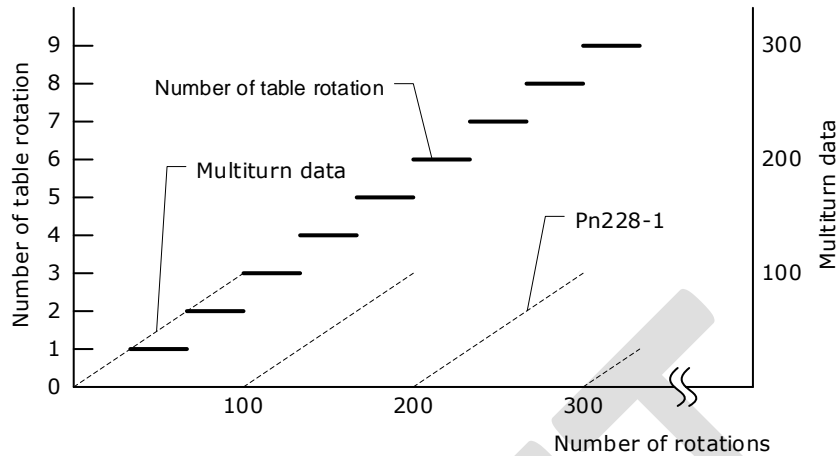

Parameter	Name	Range	Unit	Default	When Enabled
Pn228	Multiturn limit	0 to 65535	1 rev	10	After restart

Note: This parameter is enabled when you use an absolute encoder.

The data will change as shown below when this parameter is set to anything other than the default setting.

- If the motor operates in the reverse direction when the multiturn data is 0, the multiturn data will change to the value set in (Pn228-1).
- If the motor operates in the forward direction when the multiturn data is at the value set in (Pn228-1), the multiturn data will change to 0.

NOTE

The multiturn data will always be 0 in the following cases. It is not necessary to reset the absolute encoder in these cases.

- When you use a single-turn absolute encoder
- When you set Pn002.2 = 1 (Use the encoder as an incremental encoder)

5.6.4 Encoder pulse dividing output

Pulse dividing signals

Encoder pulse dividing pulse output processes the signals sent from the encoder inside the driver, and outputs such signals to the outside in the form of two-phase pulses (Phase A, and Phase B) with 90° phase differential. It can be used as position feedback in the host controller.

Signal Name	Connector Pin Number	Name	Description
PAO+	CN1-20	Encoder pulse dividing output Phase A	PG pulse dividing (Pn200): the number of pulses when motor rotates a single revolution
PAO-	CN1-21		
PBO+	CN1-22	Encoder pulse	The phase differential between phase A

Signal Name	Connector Pin Number	Name	Description
PBO-	CN1-23	dividing output Phase B	and phase B here is electrical angle of 90°
PCO+	CN1-24	Encoder pulse dividing output Phase C	The actual phase C output of encoder
PCO-	CN1-25		

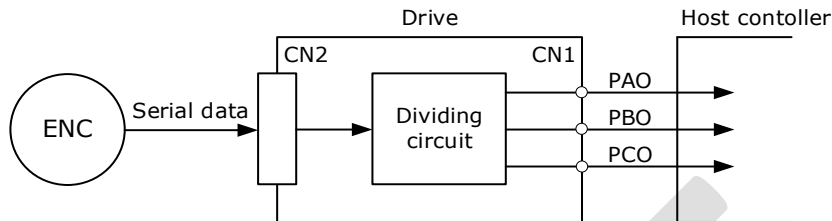

Note: Even in the reverse mode (Pn001.0=1), the pulse dividing output phase form is the same as the standard setting (Pn001.0=0).

Output Phase Form

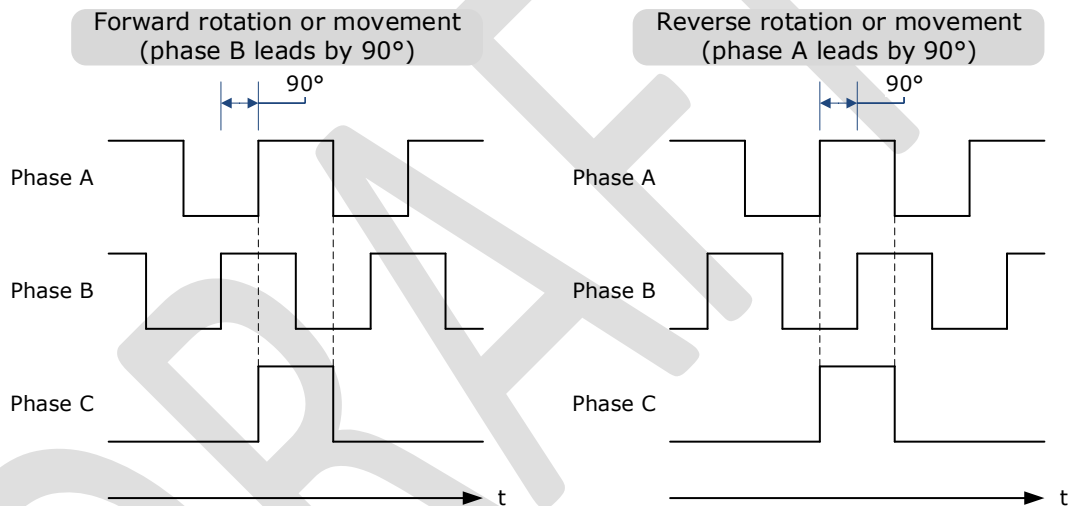

Pulse Dividing Ratio Setting

Encoder pulse dividing means that the divider converts data into the pulse density (Pn200) set by the user parameter based on the pulse data of the motor encoder, and outputs it. The setting unit is number of pulses/revolution.

No.	Name	Range	Unit	Default	When Enabled
Pn200	PG dividing ratio	16 to 16384	1 pulse	16384	After restart

- Set the number of pulses for PG output signals (PAO, /PAO, PBO, /PBO) externally from the servo drive through Pn200.
- Feedback pulses from the encoder per revolution are divided inside the servo drive by the number set in Pn200 before being output.
- Set the encoder pulse dividing ratio according to the system specifications of the machine or host controller.
- The setting of the encoder pulse dividing number is restricted by the encoder's resolution.

[Output Example] Pn200=16 (when 16 pulses are output per revolution), the output examples of signals of encoder pulse dividing output phase A (PAO) signal and encoder pulse dividing output phase B (PBO) are shown below.

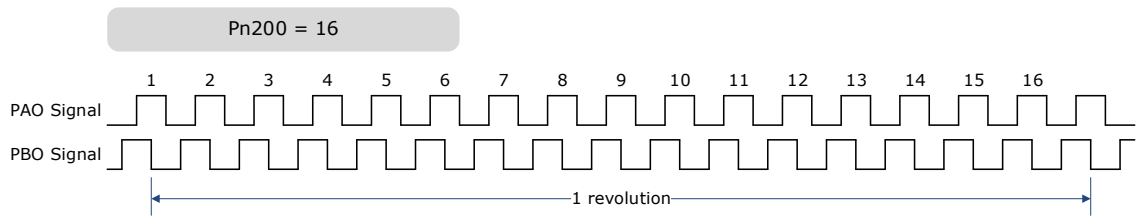

5.7 IO Signal Allocation

Functions are allocated to the pins on the I/O signal connector (CN1) in advance. You can change the allocations and the polarity for some of the connector pins. Function allocations and polarity settings are made with parameters.

Operation panel can only display 5 digits. When distributing IO signals, it is necessary to display or set all the signals by page turning. The display instructions are detailed as follows (take Pn509 as an example).

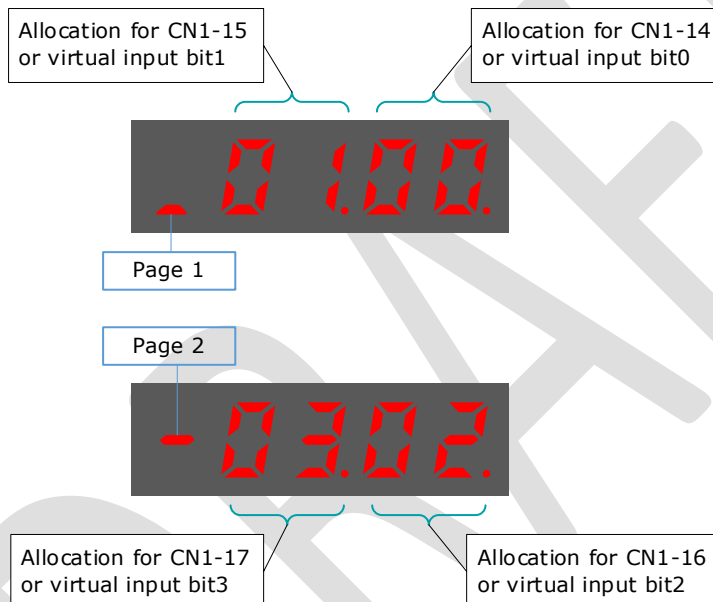

5.7.1 Input Signal Allocations

Allocation Description

CN1 provides a total of 8 pin numbers available for allocation of input signals, corresponding to the sub-parameters of Pn509 and Pn510. Moreover, there're 8 virtual input bits controlled by Modbus communication, corresponding to the sub-parameters of Pn709 and Pn710.

**IMPORTANT**

- If you allocate two or more signals to the same input circuit, a logical OR of the inputs will be used and all of the allocated signals will operate accordingly. This may result in unexpected operation.
- Since the pins have priority, only the highest priority pin is in effect if a signal is repeatedly allocated to multiple pin. The priority of the pins is arranged from high to low as follows:
CN1-14 < CN1-15 < CN1-16 < CN1-17 < CN1-39 < CN1-40 < CN1-41 < CN1-42 < bit8 < bit9 < bit10 < bit11 < bit12 < bit13 < bit14 < bit15

Default Input Signals

Table 5-2 lists the input signals that can be allocated and their corresponding values. Set the sub-parameters of Pn509, Pn510, Pn709 and Pn710 to use the following values, which means that they are allocated to the corresponding pins.

Table 5-2 Default Input signals

Signal	Name	Value
S-ON	Servo ON Input Signal	00
P-CON	Proportional Control Reference	01
P-OT	Forward Drive Prohibit Input Signal	02
N-OT	Reverse Drive Prohibit Input Signal	03
ALMRST	Alarm Clear	04
CLR	Clear Position Deviation Pulse	05
P-CL	Forward External Torque Limit Input Signal	06
N-CL	Reverse External Torque Limit Input Signal	07
G-SEL	Gain Selection Input Signal	08
JDPOS-JOG+	PCP Control, PJOG positive command	09
JDPOS-JOG-	PCP Control, PJOG negative command	0A
JDPOS-HALT	PCP Control, stop command	0B
HmRef	Homing Input Signal	0C
SHOM	Homing Start Signal	0D
ORG	Reference Switch Signal	0E
ZCLAMP	Zero Clamp Signal	0F
TORQ_JD1	Internal torque contact 1	10
TORQ_JD2	Internal torque contact 2	11
TORQ_SPEED_LIMIT1	Internal torque reference limit 1	12
TORQ_SPEED_LIMIT2	Internal torque reference limit 2	13
ANLOD_REV	Analog input command negation When the control mode is of D-parameter speed, the given speed is reversed	14
POS0	Select PCP connection point as 0	15
POS1	Select PCP connection point as 1	16

Signal	Name	Value
POS2	Select PCP connection point as 2	17
POS3	Select PCP connection point as 3	18
POS4	Select PCP connection point as 4	19
ANAG_SEL	Switch the speed command input gain from Pn300 to Pn302 in analog speed control mode. Switch the torque command input gain from Pn400 to Pn414 in analog torque control mode.	1A
MDP1	Reserved	1A
MD0	Reserved	1B
MD1	Reserved	1C

5.7.2 Output Signal Allocations

Allocation Description

The I/O signal connector (CN1) on the Drive provides three group of pins (points) for allocating the output signals, corresponding to the parameter Pn511, as is shown in Figure 5-3.

Figure 5-3 Allocation of output signals

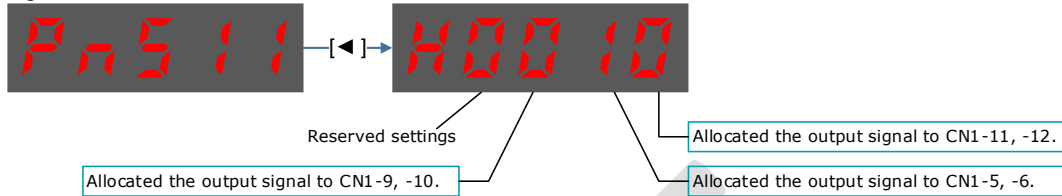

IMPORTANT

If you allocate more than one signal to the same output circuit, a logical OR of the signals will be output.

Default Output Signals

Table 5-3 lists the output signals that can be allocated and their corresponding values. Set the parameter Pn511 to use the following values, which means that they are allocated to the corresponding pins.

Table 5-3 Default Output signals

Signal	Name	Value
COIN/VCMP	Positioning Completion Output Signal or Speed Coincidence Detection Output Signal	0
TGON	Rotation Detection Output Signal	1
S-RDY	Servo Ready Output Signal	2
CLT	Torque Limit Detection Output Signal	3
BK	Brake Output Signal	4
PGC	Motor C-pulse Output Signal	5
OT	Overtravel Output Signal	6
RD	Motor Excitation Output Signal	7
HOME	Homing Completion Output Signal	8
TCR	Torque Detection Output Signal	9
R-OUT1	Remoted IO Output Signal 0	A
R-OUT2	Remoted IO Output Signal 1	B
R-OUT3	Remoted IO Output Signal 2	C

5.8 Control Mode Selection

Speed control, position control and torque control are available to servo drive. Set through the control mode selection (Pn005.1).

Parameter	Set Value	Control Mode	Description
Pn005.1	0	Speed Control (Analog Reference)	Controls servomotor speed using analog voltage speed reference.
	1	Position Control (Reference)	Controls the position of the servomotor using pulse train position reference. Controls the position with the number of input pulses, and controls the speed with the input pulse frequency. Use when positioning is required.
	2	Torque Control	Controls the servomotor's output torque with analog voltage torque reference. Use to output the required amount of torque for operations such as pressing.
	3	Speed Control (contact reference) ↔Speed Control (zero reference)	Use 7 speed parameters (Pn316 to Pn322) and zero reference (halt) pre-set in the servo drive for speed control. When this control mode is selected, no analog reference is required.
	4	Speed Control (contact reference) ↔Speed Control (analog reference)	These are switching modes for using the above-mentioned control methods described above in combination. Select the control method switching mode that best suits the application.
	5	Speed Control (contact reference) ↔Position Control (pulse train reference)	
	6	Speed Control (contact reference) ↔Torque Control	
	7	Position Control (pulse train reference) ↔ Speed Control (analog reference)	
	8	Position Control (pulse train reference) ↔ Torque Control	
	9	Torque Control ↔ Speed Control (analog reference)	

Parameter	Set Value	Control Mode	Description
	A	Speed Control (analog reference) ↔Zero Clamp Control	Use zero clamp function under speed control mode.
	B	Position Control (pulse train reference)↔ Position Control (pulse prohibited)	Use pulse prohibited function under position control mode.
	C	PCP Control	Pre-set the position control and P Jog operation of 32 program contacts in the servo drive. When this control mode is selected, the signal input of an external linear drive is not required.
	D	Position Control (Parameter reference)	Use the speed control of a speed parameter (Pn304) pre-set in the servo drive. When this control mode is selected, no analog reference is required.

5.9 Speed Control

Speed control is selected by Pn005.1:

Parameter	Setting	Meaning	When Enabled
Pn005.1	0	Control mode selection: speed control (analog reference)	After restart

5.9.1 Setting speed control

Speed reference input signal

To control the speed of the servo motor at a speed proportional to the input voltage, it is necessary to set the speed reference input signal.

Type	Signal Name	Connector Pin Number	Meaning
Input	VREF+	CN1-1	Speed Reference Input Signal
	VREF-	CN1-2	

[Note] Maximum input voltage: DC $\pm 10V$.

When performing position control by a host controller such as a programmable controller, connect it to the speed reference output terminal of the host controller.

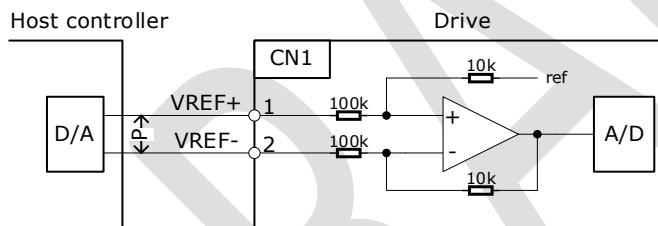

NOTE ←P→ represents a twisted-pair cable.
To suppress noise, be sure to use twisted-pair cables.

Setting speed reference input gain

Sets the analog voltage level for the speed reference (V-REF) necessary to operate the servomotor at the rated speed through Pn300.

Number	Name	Range	Unit	Default	When Enabled
Pn300	Analog Speed Reference Input Gain	0 to 3000	rpm/V	150	Immediately

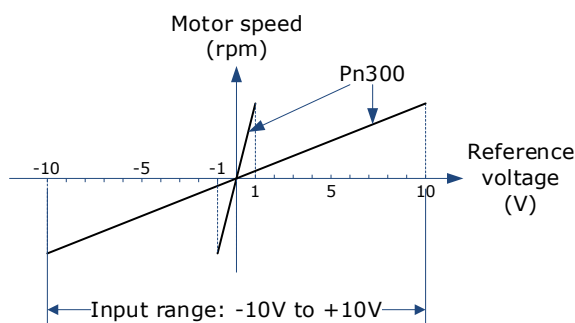

Speed Reference Input Example

Pn300=150 [factory setting]:

Speed Reference Input	Direction	Motor Speed
+1V	Forward	150rpm
+5V	Forward	750rpm
-10V	Reverse	-1500rpm

5.9.2 Adjustment of Speed Reference Offset:

When speed control is used, even if the command is 0V (the command speed is 0 or halted), the servo motor may rotate at a slight speed. This is because there is a slight deviation in the reference inside the servo unit. This slight deviation is called "offset". When the servo motor is moving at a slight speed, it is necessary to use the offset adjustment function to eliminate the offset.

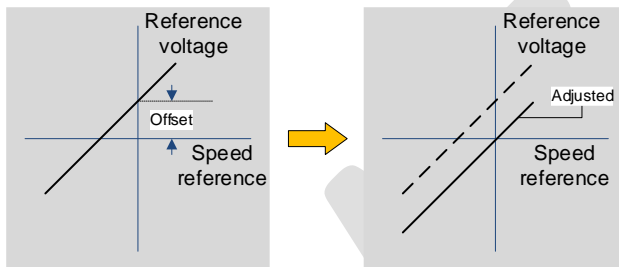

Auto Adjustment of Speed Reference Offset:

The auto adjustment of the Speed Reference Offset is a method for the servo drive to automatically adjust the voltage of the speed command after offset measurement.

NOTE

- The measured offset will be saved in the servo drive.
- The offset is not a parameter, so the offset will not be reset even if the parameter factory value (Fn001) is restored.

Following provides the steps for auto adjustment of the Speed Reference Offset.

Step 1 Confirm that the servo drive is in the servo OFF state.

Step 2 Input 0V command voltage from the host controller or external circuit.

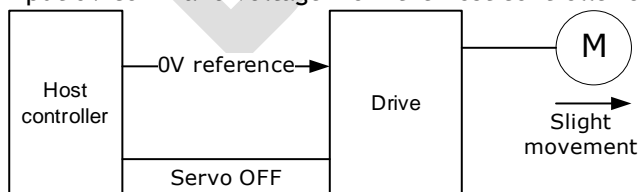

Step 3 Press [M] key several times to select the Utility Function Mode.

Fn000

Step 4 Press [▲] key or [▼] key to select the function number Fn003.

Fn003

Step 5 Press [◀] key and the operating panel is displayed as follows.



Step 6 Press [M] key to execute automatic offset adjustment.

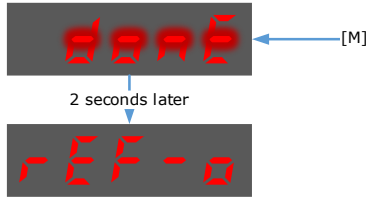

Step 7 Press the [◀] key to return to the display of the Fn003.

----End

Manual Adjustment of Speed Reference Offset

The manual adjustment of the speed reference offset is a method that inputs the speed command offset directly for adjustment. Use the manual adjustment in the following situations.

- If a loop is formed with the host controller and the position error pulse is set to be zero when servolock is stopped.
- To deliberately set the offset to some value.
- To check the offset data set in the speed reference offset auto adjustment mode.
- Following provides the steps for manual adjustment of the Speed Reference Offset.

Step 1 Input 0V command voltage from the host controller or external circuit.

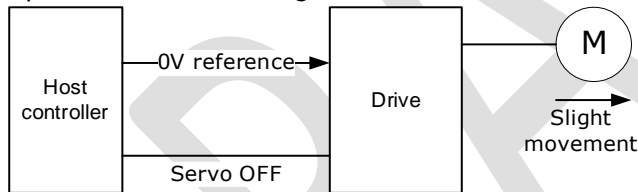

Step 2 Press [M] key on operating panel for several times to select the Utility Function Mode.



Step 3 Press [▲] key or [▼] key to select the function number Fn004.



Step 4 Press [◀] key and the operating panel is displayed as follows.



Step 5 Turn ON the servo S-ON signal, so that the servo drive enters the servo ON state.

Step 6 Press the [M] key for one second to display the current speed reference offset.



Step 7 Press [▲] key or [▼] key to adjust the offset manually.

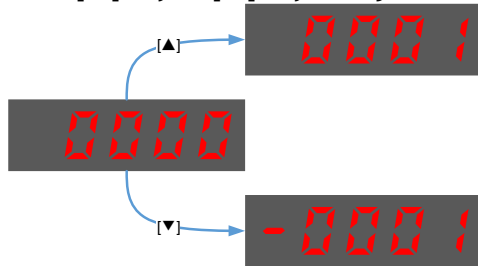

[Note] The adjustment range of the offset is -1024 to 1024.

Step 8 Press and hold the [◀] key for 1 second to return to the manual adjustment display.



Step 9 Press the [M] key to return to the display of the Fn004.

---End

5.9.3 Soft Start

The soft start function converts the stepwise speed reference inside the drive to a consistent rate of acceleration and deceleration.

First, the user needs to select the running curve of the speed reference via Pn310 (speed reference curve form).

Parameter	Name	Setting	Description	When Enabled
Pn310	Speed reference curve form	0	Ramp [factory setting]	After restart
		1	S curve	
		2	Primary filtering	
		3	Secondary filtering	

Use this function when you want to achieve smooth speed control (including internally set speed control).

When speed reference uses ramp form (Pn310=0)

The figure below shows the timing diagram of the speed reference in the ramp form (Pn310=0). Among them, Pn306 is the time interval for the motor to accelerate from the stop state to speed of 1000rpm, and Pn307 is the time interval for the motor from 1000rpm to the stop state.

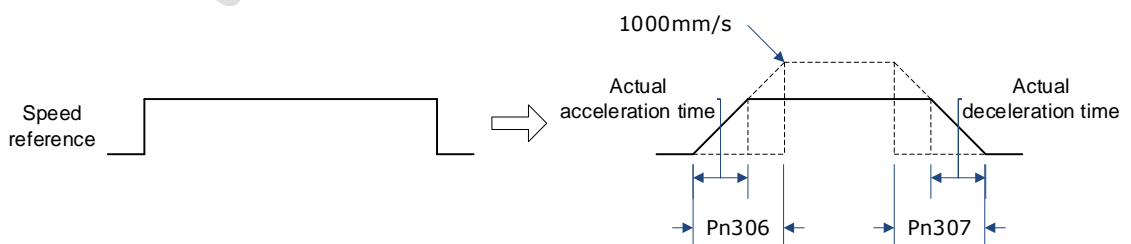

Where:

$$\text{Actual acceleration time} = \frac{\text{Target speed}}{1000} \times Pn306$$

$$\text{Actual deceleration time} = \frac{\text{Target speed}}{1000} \times Pn307$$

Parameter	Name	Range	Unit	Default	When Enabled
Pn306	Soft Start Acceleration Time	0 to 10000	ms	0	Immediately
Pn307	Soft Start Deceleration Time	0 to 10000	ms	0	Immediately

When speed reference uses S-curve (Pn310=1)

The figure below shows the timing diagram of the speed reference in the S-curve (Pn310=1). Among them, Pn309 is the time interval for the motor to accelerate from the stop state to the target speed, or the time interval for the motor to decelerate from the target speed to the stop state.

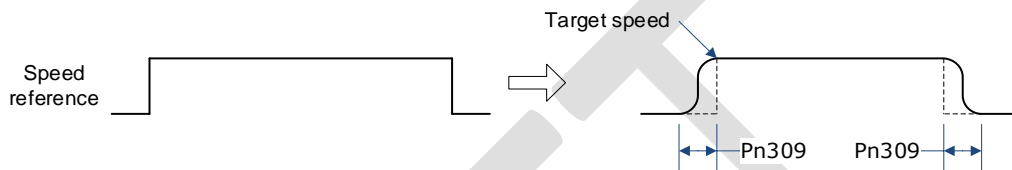

Moreover, transition form of the S-curve via Pn311 can also be selected. User can try and choose the appropriate setting.

Parameter	Name	Range	Unit	Default	When Enabled
Pn309	S-curve rising time	0 to 10000	ms	0	Immediately
Pn311	S shape selection	0 to 3	-	0	After restart

When speed reference uses filtering (Pn310=2 or 3)

Pn308 (speed filter time constant) smooths the speed reference by applying a 1st-order delay filter can be applied to the analog speed reference (VREF) input.

This parameter is generally not set. If the set value is too large, the responsiveness may be reduced. It is recommended to set while confirming the responsiveness.

Parameter	Name	Range	Unit	Default	When Enabled
Pn308	Speed Reference Filter Time Constant	0 to 10000	ms	0	Immediately

5.9.4 Zero Clamp Function

When the zero clamp function is used for speed control, the upper controller is a system that forms a loop.

The zero clamp function locks the servo when the input voltage of the speed reference (VREF) drops below the set speed in the zero clamp level parameter (Pn502) while the zero clamp signal (/ZCLAMP) is ON (low level). By this moment, a loop is formed inside the servo drive, ignoring the speed reference.

Parameter	Name	Range	Unit	Default	When Enabled
Pn502	Zero Clamp Speed	0 to 3000	rpm	10	Immediately

The servo motor is fixed within ± 1 pulse of the zero clamp effective position. Even if it moves due to external force, it returns to the zero-clamp position.

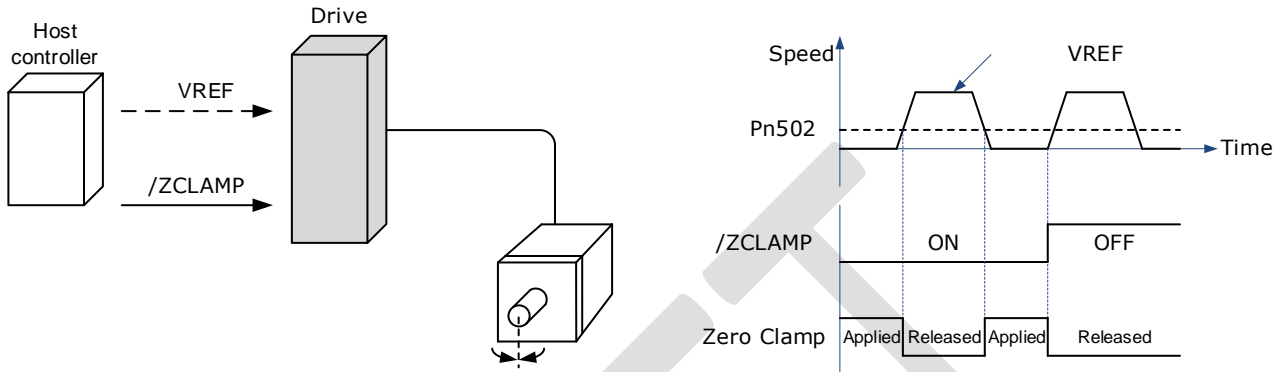

Adjust the position loop gain in Pn104 (position loop gain) if the servomotor oscillates in the zero clamp state. If the gain switching function is used, adjusting Pn109 (2nd position loop gain) is also required.

Zero-Clamp Signal Allocations

The /ZCLAMP signal is not allocated in the factory setting, and the user needs to set it through Pn509 or Pn510.

Type	Signal	Connector Pin Number	Signal State	Meaning
Input	/P-CON	CN1-15	ON (Low level)	Zero clamp function is active
			OFF (High level)	Zero clamp function is inactive
	/ZCLAMP	Allocated via Pn509 or Pn510	ON Low level)	When the input voltage of the speed reference input (VREF) falls below the speed set by Pn502 (zero-clamp speed), the zero clamp function will be validated.
			OFF (High level)	Zero clamp function is inactive

Setting Zero Clamp Function

When the control mode (Pn005.1) is set to A, the zero clamp function is active when the following two conditions are satisfied

- Low level when /P-CON is ON
- The speed reference (VREF) drops below the set value of Pn502

Parameter	Setting	Meaning	When Enabled
Pn005.1	A	Control mode selection: Speed control (analog reference) ↔ Zero clamp control	After restart

5.9.5 Speed Coincidence Detection (/VCMP) Signal

The Speed Coincidence Detection (/VCMP) Signal is the signal output when the speed of the servomotor coincides with the reference speed. It is used in occasions such as interlocking with the upper controller. This output signal can only be used during speed control.

Type	Signal Name	Connector Pin Number	Signal State	Meaning
Output	/VCMP	CN1-11, 12	ON (low level)	Speed coincides.
			OFF (high level)	Speed does not coincide.

[Note] In position control, CN1-11, 12 output /COIN (positioning completion) signal.

This output signal can be distributed to other output terminals via Pn511. For details, please refer to "5.7.2 Output Signal Allocation".

No.	Name	Range	Unit	Default	When Enabled
Pn501	Speed Coincidence Error	0 to 100	rpm	10	Immediately

The VCMP signal is output when the difference between the motor speed and the reference speed drops below the set speed of Pn501.

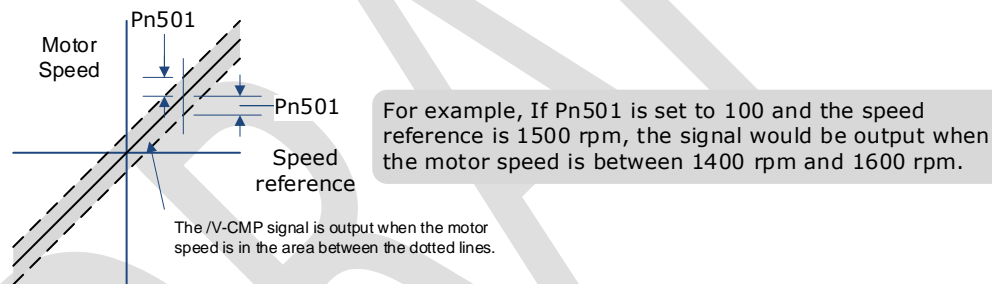

5.10 Position Control

Use Pn005.1 to select Position Control:

Parameter	Setting	Meaning	When Enabled
Pn005.1	1	Control mode selection: position control (pulse train reference)	After restart

The control block diagram for position control is shown in figure below.

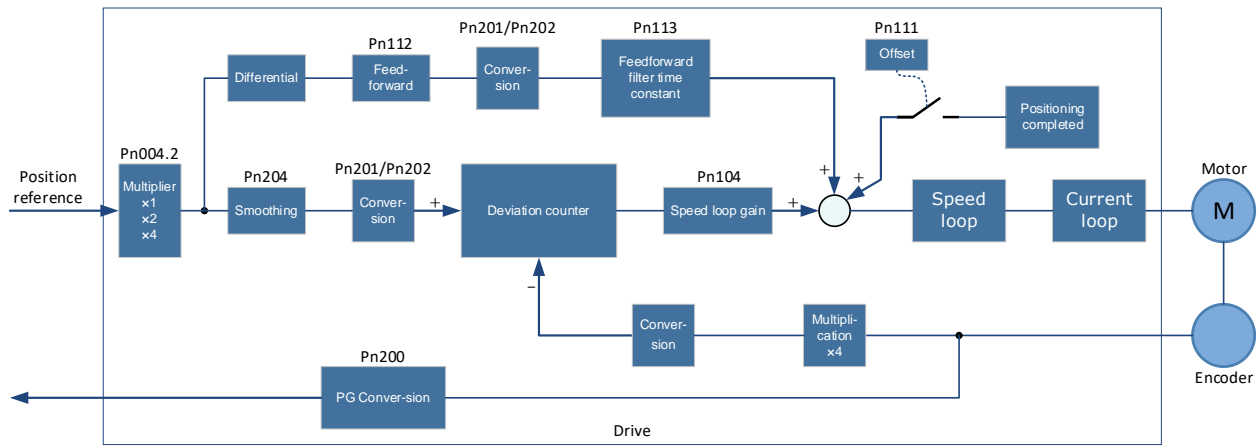

5.10.1 Basic Settings of Position Control

Setting position reference input form

Use Pn004.2 to set the input form of the position reference.

Parameter Setting	Multiplier	Input form	Forward Reference	Reverse Reference
Pn004.2 = 0	-	SIGN + PULS [Positive Logic]	PULS SIGN	PULS SIGN
Pn004.2 = 1	-	CW + CCW [Positive Logic]	CW CCW	CW CCW
Pn004.2 = 2	1	90° phase difference two-phase pulse	Phase A Phase B	Phase A Phase B
Pn004.2 = 3	2			
Pn004.2 = 4	4			

The input multiplier can be set when the 90° phase difference is of two-phase pulse reference form.

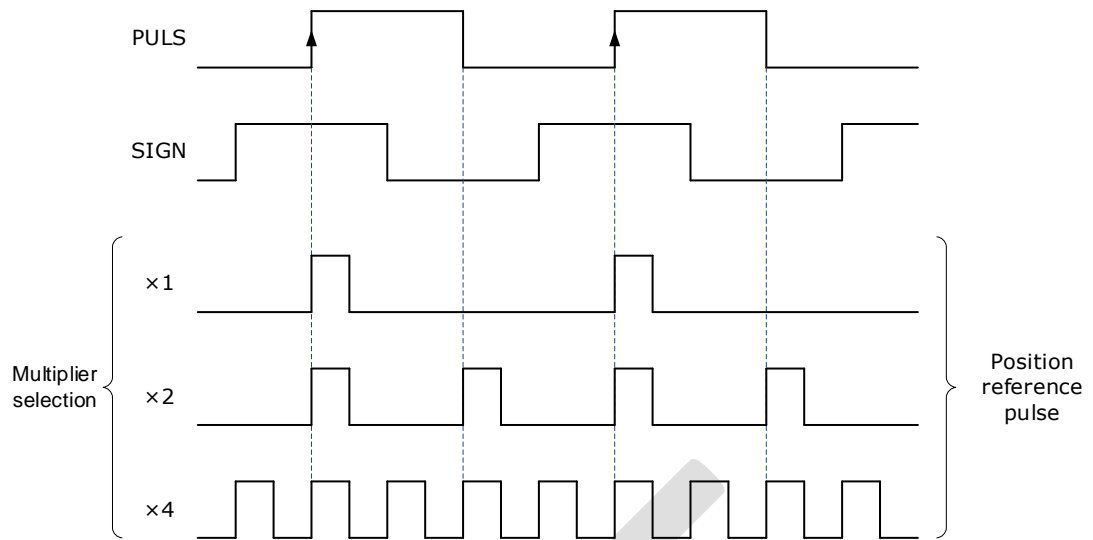

Also, the user can choose whether to invert the PULS signal and SIGN signal using Pn004.3.

Parameter	Setting	Meaning	When Enabled
Pn004.3	0	Both PULS reference and SIGN reference are not inverted	After restart
	1	PULS reference is not inverted, but SIGN reference is inverted	
	2	PULS reference is inverted, but SIGN reference is not inverted	
	3	Both PULS reference and SIGN reference are inverted	

Electrical specifications for position reference input

Reference Pulse Signal Form	Electrical Specification	Remark
<p>SIGN + PULS</p> <p>Max reference frequency: 500kpps (For open-collector output: 200kpps)</p>	<p>Forward reference: $t_4, t_5, t_6 \geq 3.0\mu s$</p> <p>Reverse reference: $t_4, t_5, t_6 \geq 3.0\mu s$</p>	<p>$t_1, t_2, t_3, t_7 \leq 0.1\mu s$</p> <p>$\tau \geq 1.0\mu s$</p> <p>$\tau \div T \leq 0.5$</p> <p>The sign (SIGN) is a forward rotation reference at H level, and a reverse rotation reference at L level.</p>
<p>CW + CCW</p> <p>Max reference frequency: 500kpps (For open-collector output: 200kpps)</p>	<p>Forward reference: $t_4 \geq 3\mu s$</p> <p>Reverse reference: $t_4 \geq 3\mu s$</p>	<p>$t_1, t_2 \leq 0.1\mu s$</p> <p>$t_3 \geq 3\mu s$</p> <p>$\tau \geq 1.0\mu s$</p> <p>$\tau \div T \leq 0.5$</p> <p>—</p>

Reference Pulse Signal Form	Electrical Specification	Remark
90° phase difference two-phase pulse (Phase A + Phase B) Max reference frequency (before frequency multiplier): ×1 input pulse multiplier: 500kpps ×2 input pulse multiplier: 400kpps ×4 input pulse multiplier: 200kpps		$t_1, t_2 \leq 0.1\mu\text{s}$ $\tau \geq 1.0\mu\text{s}$ $\tau \div T = 0.5$ Select the frequency multiplier via Pn004.2.

Connection Example

The pulse train output form of the reference controller includes the followings.

- Linear drive
- +24V open-collector output
- +12V/+5V open-collector output

[Connection Example for Linear drive Output]

Applicable linear driver: SN75174 manufactured by TI or MC3487 or the equivalent.

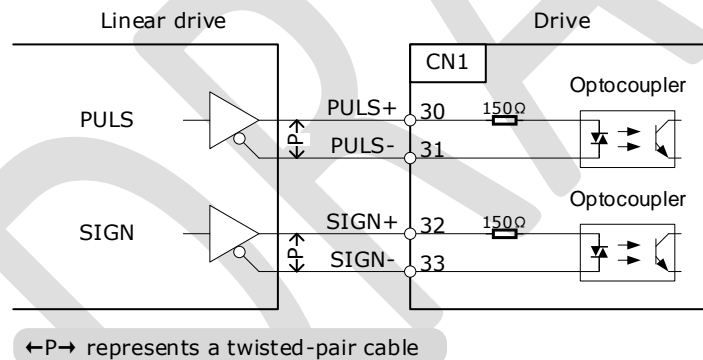

[Connection Example for Open-Collector Output]

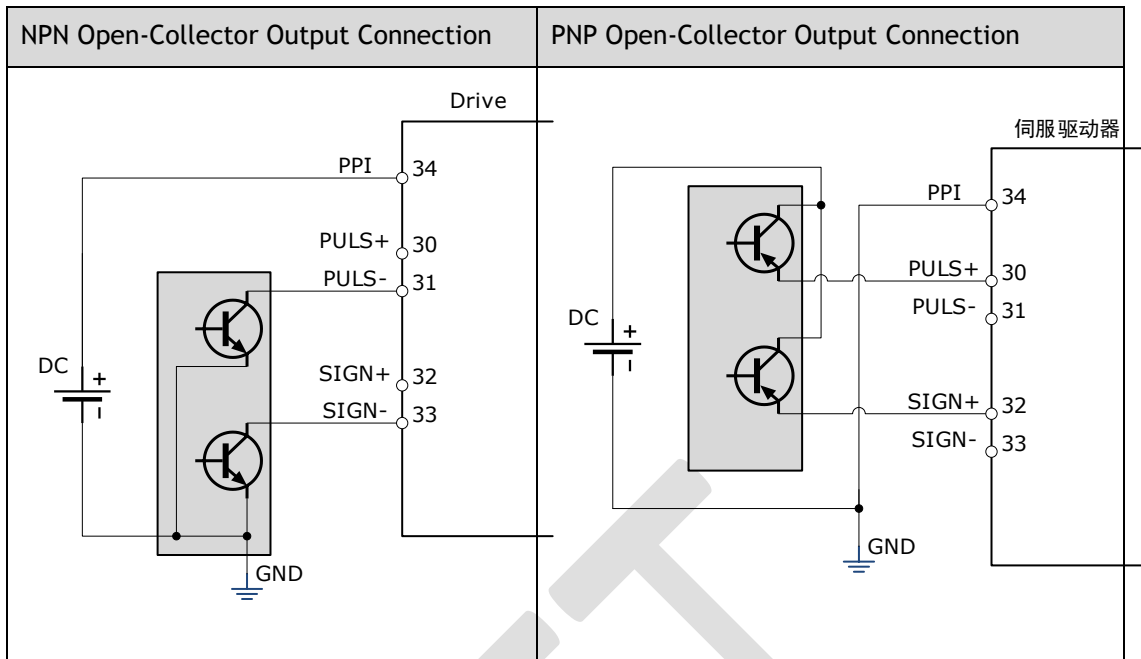

DRAFT

5.10.2 Function and Setting of Position Error Clear (/CLR) Signal

Allocation of Position Error Clear Signal

Type	Signal Name	Connector Pin Number	Meaning
Input	/CLR	CN1-40	Error counter clear

When the /CLR signal is set to low level, clear error counter:

- The error counter inside the servo drive is set to“0”
- Position loop operation is disabled.

Setting the Clear Signal Mode

In position control mode, pulses will be still presented in the servo drive when servo OFF, thus it should be cleared when servo drive is turned ON (S-ON). Setting Pn004 to choose whether clearing the pulses automatically when servo OFF.

Parameter	Setting	Meaning	When Enabled
Pn004.1	0	Clear the error pulse when S-OFF, and not clear when over-travel.	After restart
	1	Do not clear the error pulse.	
	2	Clear the error pulse when servo is OFF or over-travel (except for zero clamp)	

5.10.3 Electronic Gear

Function Overview

The electronic gear enables the workpiece travel distance per input reference pulse from the reference controller to be set to any value.

One reference pulse from the reference controller, i.e., the minimum position data unit, is called “1 reference unit”.

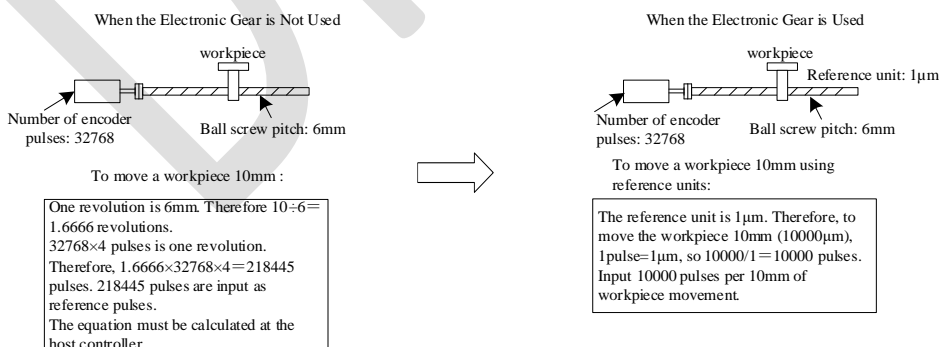

If the mechanical reduction ratio between the motor shaft and the load side is set to m/n , the setting value of the electronic gear ratio can be calculated according to following formula. (When the servomotor rotates m revolutions, the load shaft rotates n revolutions)

$$\text{Electronic Gear} \frac{B}{A} = \frac{Pn201}{Pn202} = \frac{\text{Encoder pulse number} \times 4}{\text{Travel distance per load shaft revolution}} \times \frac{m}{n}$$

 NOTE

- Range of electronic gear ratio: $0.01 \leq \text{electronic gear ratio (B/A)} \leq 100$
If the electronic gear ratio is outside this range, the servo drive will not operate properly. In this case, modify the load configuration or reference unit.
- Divide the numerator and denominator into integers within the setting range when it exceeds the setting rang.

2nd Electronic Gear Switching

Switch between electronic gear ratio numerator 1 (Pn201) and electronic gear ratio numerator 2 (Pn203) according to the external/P-CON signal. The switching sequence is determined by the setting of Pn002.0. This function is enabled by user parameter Pn001.3.

Related Parameters

Type	Signal Name	Connector Pin Number	Signal State	Meaning
Input	/P-CON	CN1-15	ON (low level)	Switch to the 2 nd electronic gear
			OFF (high level)	Switch to the 1 st electronic gear

Number	Name	Range	Unit	Default	When Enabled
Pn201	16-bit 1 st electronic gear numerator	1 to 100000	–	1	After restart
Pn202	16-bit electronic gear denominator	1 to 100000	–	1	After restart
Pn203	16-bit 2 nd electronic gear numerator	1 to 100000	–	1	After restart

Setting Steps

Set the electronic gear ratio as per the steps and instructions described in the table below.

Step	Operation	Description
1	Check machine specifications.	Check the deceleration ratio, ball screw pitch and pulley diameter.
2	Check the number of encoder pulses.	Check the number of encoder pulses for the Servo motor used.
3	Determine the reference unit used.	Determine the reference unit from the host controller, considering the machine specifications and positioning accuracy.
4	Calculate the travel distance per load shaft revolution.	Calculate the number of reference units necessary to turn the load shaft one revolution based on the previously determined reference units.
5	Calculate the electronic gear ratio.	Use the electronic gear ratio equation to calculate the ratio (B/A).
6	Set parameters.	Set parameters using the calculated values.

Setting Examples

Step	Operation	Machine Structure		
		Ball Screw	Disc Table	Belt and Pulley
		<p>Reference unit: 0.001mm Load shaft 17-bit encoder Ball screw pitch: 6mm</p>	<p>Reference unit: 0.1° Deceleration ratio: 3: 1 Load shaft 17-bit encoder</p>	<p>Reference unit: 0.01mm Load shaft Deceleration ratio: 2: 1 Pulley diameter: F 100mm 17-bit encoder</p>
1	Check machine specifications	<ul style="list-style-type: none"> Ball screw pitch: 6mm Deceleration ratio: 1/1 	<ul style="list-style-type: none"> Rotation angle per revolution: 360° Deceleration ratio: 3/1 	<ul style="list-style-type: none"> Pulley diameter: 100 mm (pulley circumference: 314mm) Deceleration ratio: 2/1
2	Encoder	17-bit: 32768P/R	17-bit: 32768P/R	17-bit: 32768P/R
3	Determine the reference unit used	1 reference unit: 0.001mm (1μm)	1 reference unit: 0.1°	1 reference unit: 0.01mm
4	Calculate the travel distance per load shaft revolution	6mm/0.001mm=6000	360° /0.1° =3600	314mm/0.01mm=31400
5	Calculate the electronic gear ratio	$\frac{B}{A} = \frac{32768 \times 4}{6000} \times \frac{1}{1}$	$\frac{B}{A} = \frac{32768 \times 4}{3600} \times \frac{3}{1}$	$\frac{B}{A} = \frac{32768 \times 4}{31400} \times \frac{2}{1}$
6	Set parameters	Pn201 = 131072 Pn202 = 6000	Pn201 = 393216 Pn202 = 3600	Pn201 = 262144 Pn202 = 31400
7	Final result	Pn201 = 32768 Pn202 = 1500	Pn201 = 32768 Pn202 = 300	Pn201 = 32768 Pn202 = 3925

NOTE

Reduce the fraction (both numerator and denominator) if the calculated result will not be within the setting range.

For example, reduce the above numerators and denominators by four or other numbers to obtain the final results in step 7 and complete the settings.

Electronic Gear Ratio Equation

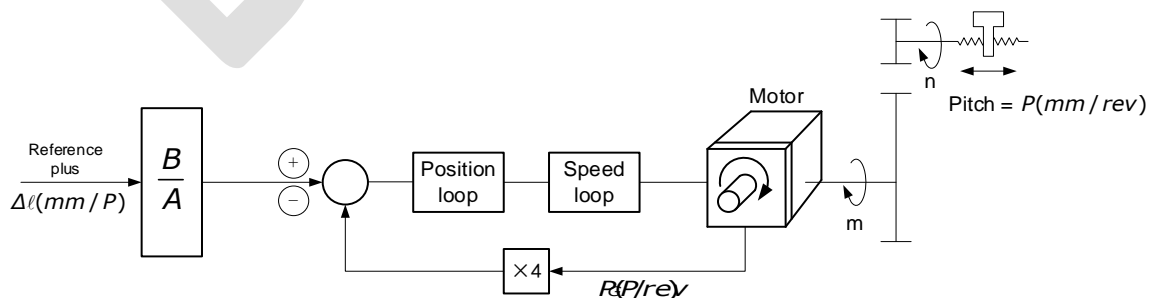

Where: Δl is the reference unit; P_G is the encoder pulse; P is the pitch of the ball screw; m/n is the reduction ratio.

$$\frac{n \times P}{\Delta l} \times \frac{B}{A} = 4 \times P_G \times m \Rightarrow \frac{B}{A} = \frac{4 \times P_G \times m \times \Delta l}{n \times P} = \frac{4 \times P_G}{\frac{P}{\Delta l}} \times \frac{m}{n}$$

Set A and B with the following parameters Pn202 and Pn201.

5.10.4 Smoothing

The smoothing filters the reference pulse input to make the travel of the servomotor smoother. This function is more effective in the following cases.

- When the host controller that outputs a reference that cannot perform acceleration/deceleration processing.
- When the reference pulse frequency is too low.
- When the conversion of position reference is large ($\frac{Pn201}{Pn202} \geq 10$)

[Note] This setting has no effect on the travel distance (reference pulse number).

Set the position reference filtering method using Pn205 (position reference filter form selection).

Number	Name	Setting	Meaning	When Enabled
Pn205	Position Reference Filter Form Selection	0 [Factory Setting]	Primary filtering to position reference	After restart
		1	Secondary filtering to position reference	

Then set the filter time of the position reference using Pn204 (position reference filter time constant).

Number	Name	Range	Unit	Default	When Enabled
Pn204	Position Reference Filter Time Constant	0 to 32767	0.1ms	0	Immediately

The figure below shows the 1st order filtering for position reference:

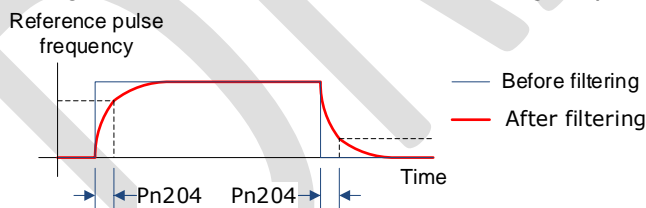

IMPORTANT

After changing this parameter, the changed parameter will be effective after user will re-input the position reference next time and input the position error clear (CLR) signal.

5.10.5 Positioning Completion (/COIN) Signal

This signal indicates that servomotor movement has been completed during position control. Use the signal to confirm that positioning has been completed at the host controller.

Type	Signal Name	Connector Pin Number	Signal State	Meaning
Output	/COIN	CN1-11, 12	ON (low level)	Positioning has been completed.
			OFF (high level)	Positioning is not completed.

[Note] CN1-11, 12 output the VCMP (speed coincidence) signals during speed control.

This output signal can be allocated to an output terminal with parameter Pn511. Refer to "0 Output Signal Allocation".

The positioning completion (COIN) signal is output when the difference (position error pulse) between the number of reference pulses output by the host controller and the travel distance of the servomotor is less than the value set in tPn500, and the stabilization time is more than the value of Pn520 (position completion time).

Number	Name	Range	Unit	Default	When Enabled
Pn500	Positioning Error	0 to 5000	μm	10	Immediately
Pn520	Position Completion Time	0 to 60000	0.1ms	500	Immediately

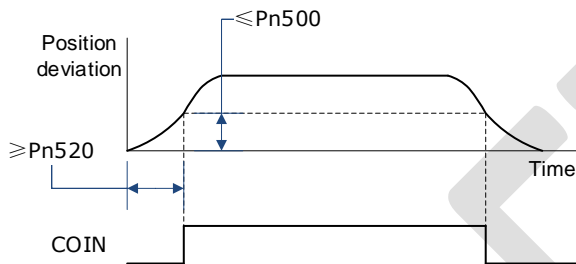

5.10.6 Reference Pulse Inhibit Function (INHIBIT)

This function stops (inhibits) the servodrive from counting input pulses during position control. When this function is active, the servodrive enters a state where it cannot receive reference pulse input.

When this function is used, it is necessary to set Pn005.1=B.

Parameter	Setting	Meaning	When Enabled
Pn005.1	B	Control mode selection: position control (pulse train reference) \leftrightarrow Position control (pulse inhibit)	After restart

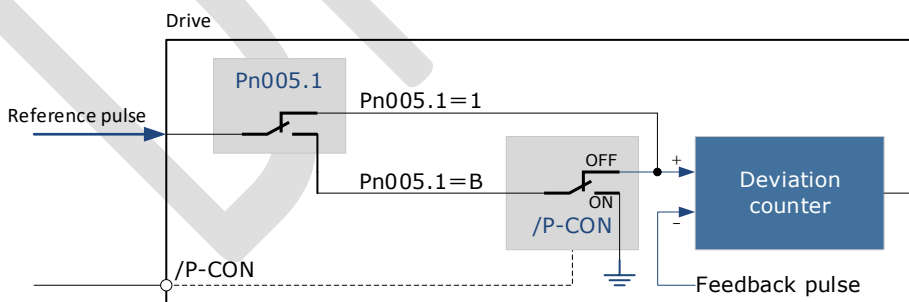

Inhibit (INHIBIT) is switched via /P-CON signal:

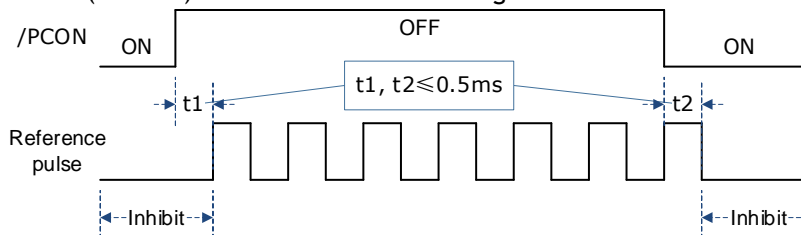

Type	Signal Name	Connector Pin Number	Signal State	Meaning
Input	/P-CON	CN1-15	ON (low level)	Stop reference pulses counting
			OFF (high level)	Start reference pulse count

DRAFT

5.11 Torque Control

This mode inputs a torque reference in the form of an analog voltage reference to the servodrive, and controls the operation of the servomotor using a torque proportional to the input voltage. This control mode needs to be selected via Pn005.1 and Pn409.

Parameter	Setting	Meaning	When Enabled
Pn005.1	2	Control mode selection: torque control	After restart
Pn409	0	Use of external analog quantity voltage reference requires the external signal connection	Immediately

5.11.1 Basic Settings of Torque Control

Specification of Torque Reference Signal Input

To apply torque control to the servomotor with a torque proportional to the input voltage, it is necessary to set the torque reference input signal.

Type	Signal Name	Connector Pin Number	Meaning
Input	TREF+	CN1-26	Torque Reference Input Signal
	TREF-	CN1-27	

[Note] Max input voltage: DC \pm 10V.

When performing position control by a host controller such as a programmable controller, connect it to the analog reference output terminal of the host controller.

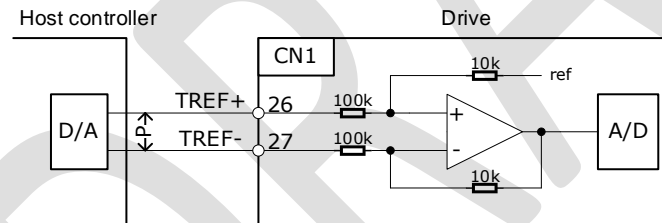

NOTE ←P→ represents a twisted-pair cable.
To suppress noise, be sure to use twisted-pair cables.

Setting Torque Reference Input Gain

Pn400 is used to set the analog voltage value of the torque reference (TREF) that operates the servomotor at the rated speed.

Number	Name	Range	Unit	Default	When Enabled
Pn400	Torque Reference Gain	10 to 100	0.1V / 100%	33	Immediately

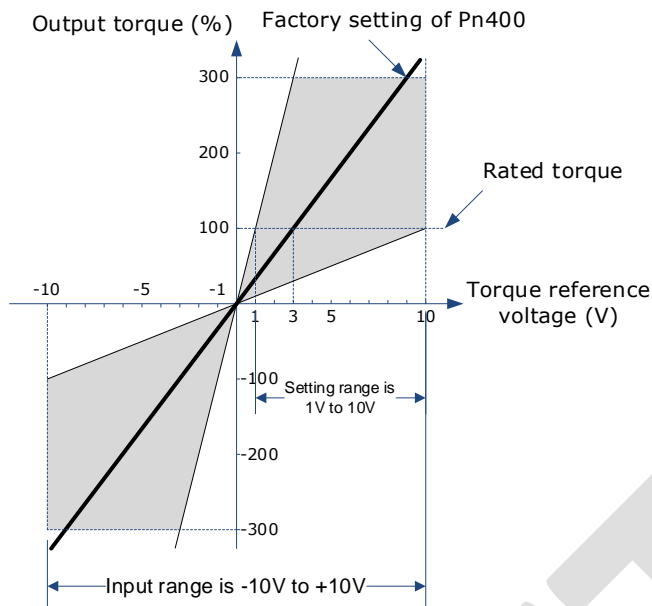

Torque Reference Input Example

When Pn400 = 30:

Torque Reference Input	Travel Direction	Torque
+3V	Forward	Rated torque
+1V	Forward	1/3 rated torque
-1.5V	Reverse	1/2 rated torque

5.11.2 Adjustment of Torque Reference Offset

When using torque control, the servomotor may rotate slowly even when 0V (reference speed is 0 or stop) is specified as the analog reference voltage. This occurs when there's slight offset for internal reference of servo drive. Such slight offset is called "Offset". When the servo motor is moving at a low speed, it is necessary to use the offset adjustment function to eliminate the offset.

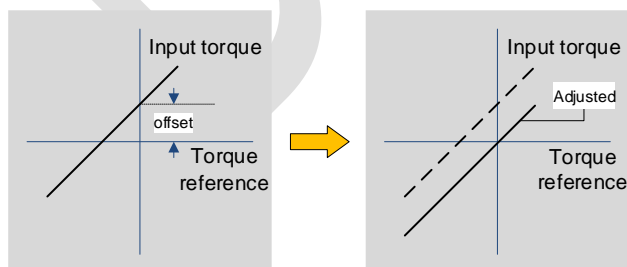

Auto Adjustment of the Torque Reference Offset

The auto adjustment of torque reference offset automatically measures the offset and adjusts the torque reference voltage automatically.

 NOTE

- The measured offset will be saved in the servo drive.
- The offset is not a parameter, so it will not be reset even if the parameter factory value (Fn001) is restored.

The following provides the operating steps for auto adjustment of the torque reference offset.

Step 1 Make sure that the servo drive is in the servo OFF state.

Step 2 Input the 0V reference voltage from the host controller or external circuit.

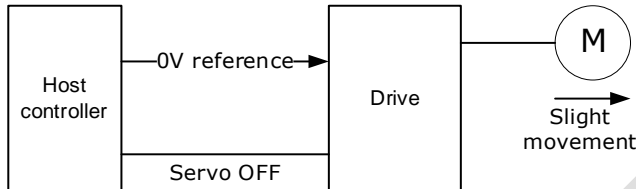

Step 3 Press the [M] key to select the utility function mode.



Step 4 Press the [▲] or [▼] key to select the utility function number Fn003.



Step 5 Press [◀] key and the operating panel is displayed as follows.



Step 6 Press the [M] key, and the reference offset will be automatically adjusted.

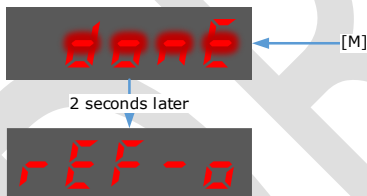

Step 7 Press the [◀] key to return to the utility function mode display Fn003.

----End

Manual Adjustment of the Torque Reference Offset

The manual adjustment of torque reference offset directly inputs the torque reference offset for adjustment. Manual adjustment is used in the following cases.

- If a position loop is formed with the host controller and the error is zeroed when servolock is stopped.
- To deliberately set the offset to some value.
- Use this mode to check the offset data that was set in the auto adjustment mode of the torque reference offset.

The following provides the operating steps for manual adjustment of the torque reference offset.

Step 1 Input the 0V reference voltage from the host controller or external circuit.

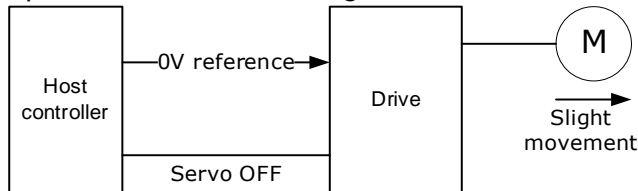

Step 2 Press the [M] key on the operating panel to select the utility function mode.

Fn000

Step 3 Press the [▲] or [▼] key to select the utility function number Fn004.

Fn004

Step 4 Press [◀] key and the operating panel is displayed as follows.

- SPd

Step 5 Turn on the S-ON signal to make the servo drive enter the servo ON state.

Step 6 Press and hold the [M] key for 1 sec or longer, the operation panel will display the current torque reference offset.

0000

Step 7 Press the [▲] or [▼] key to adjust the offset manually.

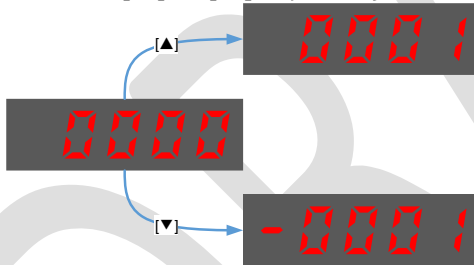

[Note] The adjustment range of the offset is -1024 to 1024.

Step 8 Press and hold the [◀] for 1 sec, and return to the display of manual adjustment.

- SPd

Step 9 Press the [◀] key to return to the function number display Fn004.

---End

5.11.3 Setting Torque Reference Input Filter

It is possible to apply a 1st-order delay filter to the analog torque reference (VREF) input via Pn105 (torque reference filter time constant), to smooth the torque reference.

This parameter is generally not set. If the set value is too large, the responsiveness may be reduced. It is recommended to set while confirming the responsiveness.

Number	Name	Range	Unit	Default	When Enabled
Pn105	Torque Reference Filter Time Constant	0 to 2500	0.01ms	50	Immediately

5.11.4 Speed Limit During Torque Control

The speed limit during torque control is a function used to limit the speed of the servomotor in order to protect the machine.

For torque control, the servomotor is controlled to output the specified torque, but the motor speed is not controlled. Therefore, if a reference torque is input that is larger than the machine torque, the speed of the servomotor may increase greatly. If that may occur, use this function to limit the speed.

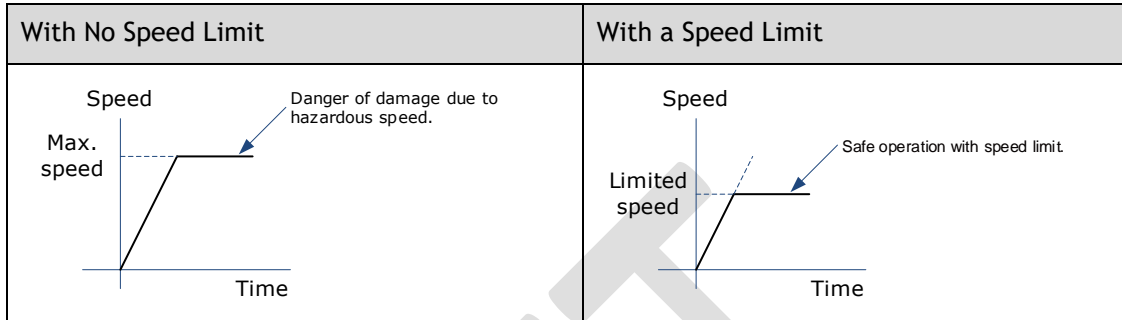

[Note] The actual limit of motor speed depends on the load conditions on the motor.

Selection of Speed Limit Detection

Select the speed limit way using Pn001.

Parameter	Setting	Meaning	When Enabled
Pn001.1	0	Use the set value of Pn408 as the speed limit value.	After restart
	1	The smaller of the speed value corresponding to the Vref input analog voltage, and the Pn408 setting value is used as the speed limit value.	

Internal Speed Limit Function

When Pn001.1=0, the internal speed limit function is selected.

In this case, user needs to set Pn408 as the limit value of the maximum motor speed. If the set value of Pn408 exceeds the maximum motor speed, the speed limit value is the maximum speed of the motor.

Number	Name	Range	Unit	Default	When Enabled
Pn408	Speed Limit During Torque Control	0 to 6000	rpm	1500	Immediately

External Speed Limit Function

When Pn001.1=1, the external speed limit function is selected. User can limit the speed via the VREF input signal and the set value of Pn408.

Type	Signal Name	Connector Pin Number	Meaning
Input	VREF+	CN1-1	Speed reference input signal
	VREF-	CN1-2	

[Note] The max. input voltage: DC \pm 10V.

Number	Name	Range	Unit	Default	When Enabled
Pn408	Speed Limit During Torque Control	0 to 6000	rpm	1500	Immediately

In torque control, the motor speed limit value is controlled by analog reference:

- When Pn001.1=1, the smaller of the speed limit input from VREF and the set value of Pn408 is valid.
- The voltage value input as the limit value depends on the set value of Pn400, not the polarity.

5.11.5 Internal Torque Contact Control

The internal torque contact control is a method to control the operation of the servo motor by the torque reference generated inside the servo drive. This control mode is selected using Pn005.1 and Pn409.

Parameter	Setting	Meaning	When Enabled
Pn005.1	2	Control mode selection: torque control	After restart
Pn409	1	Use of internal torque contact reference does not require external signal connection	Immediately

Setting Internal Torque Reference

To select a torque contact reference value, user needs to allocate TORQ_JD1 and TORQ_JD2.

Type	Signal Name	Connector Pin Number	Meaning
Input	TORQ_JD1	Allocation via Pn509 or Pn510	Internal torque contact 1
	TORQ_JD2		Internal torque contact 2

The different states of TORQ_JD1 and TORQ_JD2 can be switched to select the corresponding torque contact parameters.

TORQ_JD1	TORQ_JD2	Torque Reference Parameter
0	0	Pn410 (torque contact 1)
1	0	Pn411 (torque contact 2)
0	1	Pn412 (torque contact 3)
1	1	Pn413 (torque contact 4)

Number	Name	Range	Unit	Default	When Enabled
Pn410	Torque Contact 1	-400 to 400	%	0	Immediately
Pn411	Torque Contact 2	-400 to 400	%	0	Immediately
Pn412	Torque Contact 3	-400 to 400	%	0	Immediately
Pn413	Torque Contact 4	-400 to 400	%	0	Immediately

Setting Internal Torque Reference Limit

User needs to allocate TORQ_SPEED_LIMIT1 and TORQ_SPEED_LIMIT2 when using the torque reference limit, so as to select the required speed limit.

Type	Signal Name	Connector Pin Number	Meaning
Input	TORQ_SPEED_LIMIT1	Allocation via Pn509 or Pn510	Internal torque reference limit 1
	TORQ_SPEED_LIMIT2		Internal torque reference limit 2

The different states of TORQ_SPEED_LIMIT1 and TORQ_SPEED_LIMIT2 can be switched so as to select the corresponding torque contact parameters.

TORQ_SPEED_LIMIT1	TORQ_SPEED_LIMIT2	Torque Reference Parameter
0	0	Pn316 (speed limit 1)
1	0	Pn317 (speed limit 2)
0	1	Pn318 (speed limit 3)
1	1	Pn319 (speed limit 4)

Number	Name	Range	Unit	Default	When Enabled
Pn316	Speed Limit 1	-6000 to 6000	rpm	100	Immediately
Pn317	Speed Limit 2	-6000 to 6000	rpm	200	Immediately
Pn318	Speed Limit 3	-6000 to 6000	rpm	300	Immediately
Pn319	Speed Limit 4	-6000 to 6000	rpm	-100	Immediately

5.12 Internally Set Speed Control

It is a function that allows to set up to 7 motor speeds in the internal parameters of the servo drive, and selects the speed and moving direction from them through external input signals for speed control and operation. Since it is controlled by the internal parameters of the servo drive, a speed generator and pulse generator are not required to be installed externally.

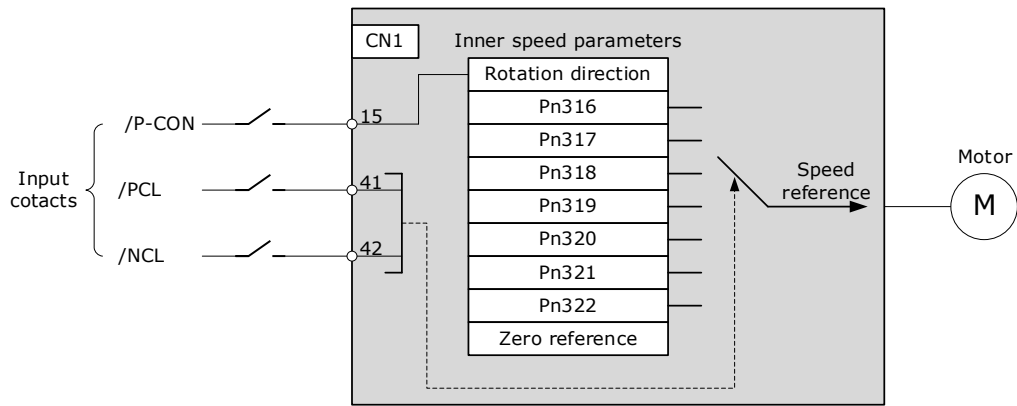

5.12.1 Basic Settings of Internally Set Speed Control

Setting Input Signal

The input signals for switching the operating speed are listed in table below.

Type	Signal Name	Connector Pin Number	Meaning
Input	P-CON	CN1-15	Switch the moving direction of the servo motor.
	PCL	CN1-41	Select the internally set speed.
	NCL	CN1-42	Select the internally set speed.

Selection of Internally Set Speed Control

Use Pn005.1 to select the torque control:

Parameter	Setting	Meaning	When Enabled
Pn005.1	3	Control mode selection: speed control (contact reference) ↔ speed control (zero reference)	After restart

5.12.2 Speed Setting of Internally Set Speed

Number	Name	Range	Unit	Default	When Enabled
Pn316	Internally Set Speed 1	-6000 to 6000	rpm	100	Immediately
Pn317	Internally Set Speed 2	-6000 to 6000	rpm	200	Immediately
Pn318	Internally Set Speed 3	-6000 to 6000	rpm	300	Immediately
Pn319	Internally Set Speed 4	-6000 to 6000	rpm	-100	Immediately
Pn320	Internally Set Speed 5	-6000 to 6000	rpm	-200	Immediately

Number	Name	Range	Unit	Default	When Enabled
Pn321	Internally Set Speed 6	-6000 to 6000	rpm	-300	Immediately
Pn322	Internally Set Speed 7	-6000 to 6000	rpm	500	Immediately

5.12.3 Switching Internally Set Speed by Input Signal

Use ON/OFF combinations of the following input signals to select the internally set speeds.

Signal			Motor Travel Direction	Operating Speed
/P-CON	/PCL	/NCL		
OFF	OFF	OFF	Forward	Switch to speed control (zero reference).
	OFF	ON		Run at internally set speed 1 as set by Pn316.
	ON	OFF		Run at internally set speed 2 as set by Pn317.
	ON	ON		Run at internally set speed 3 as set by Pn318.
ON	OFF	OFF	Reverse	Run at internally set speed 4 as set by Pn319.
	OFF	ON		Run at internally set speed 5 as set by Pn320.
	ON	OFF		Run at internally set speed 6 as set by Pn321.
	ON	ON		Run at internally set speed 7 as set by Pn322.

5.12.4 Running Example of Internally Set Speed Control

Figure below shows an example of operation during internally set speed control. This example is the operation method when internally set speed control and soft start are used in combination.

Using the soft start function would reduce the impact of speed switching.

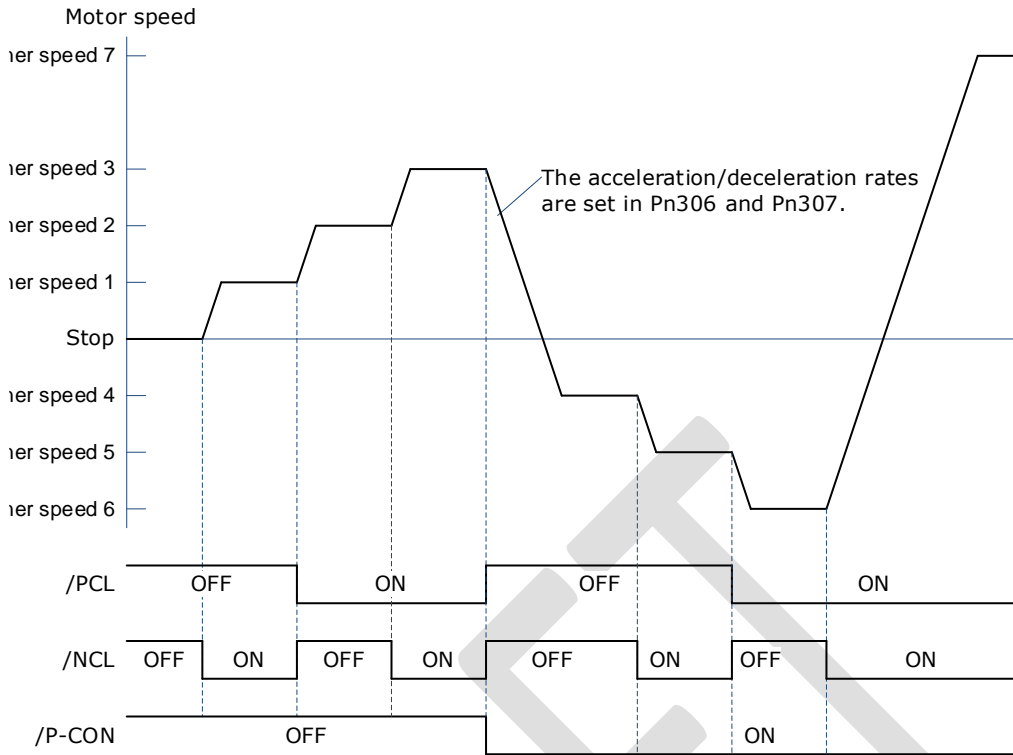

DRAFT

5.13 PCP Control

This function uses the 32 program contacts (PCP[0] to PCP[31]) preset in the drive for purpose of position control and PJOG operation.

When PCP control is selected, the drive will be controlled by the internal pulse generator to generate reference pulses based on the settings of the related parameters. In this case, the signal input from an external linear drive is not required.

5.13.1 PCP Control Selection

Select PCP control by setting Pn005.1=C.

Parameter	Setting	Meaning	When Enabled
Pn005.1	C	Control mode selection: position control (contact reference)	After restart

5.13.2 Parameter Setting of PCP Control

Parameter Setting of Contact

Servo drive allows to set a total of 32 point references (PCP[0] to PCP[31]). Each contact reference includes pulse reference, speed, attribute, acceleration/deceleration and delay.

Position contact parameter	Pulse reference	Speed	Attribute	Acceleration	Deceleration	Delay
PCP[0]	PnA00	PnA32	PnA64	PnB00	PnB32	PnB64
PCP[1]	PnA01	PnA33	PnA65	PnB01	PnB33	PnB65
PCP[2]	PnA02	PnA34	PnA66	PnB02	PnB34	PnB66
⋮	⋮	⋮	⋮	⋮	⋮	⋮
PCP[31]	PnA31	PnA63	PnA95	PnB31	PnB63	PnB95

The pulse reference defines the number of pulses of the contact, the speed defines the running speed of the contact, the attributes defines the motion attribute of contact, the acceleration and jerk define the acceleration/deceleration of the contact, and the delay defines the delay time after the contact reference is sent.

Use Pn014.1 to set the IO trigger mode.

Parameter	Setting	Meaning	When Enabled
Pn014.1	0	Edge trigger mode: Contact is triggered at the falling edge of the /PCON signal, and the servo then reads the contact number	After restart
	1	Level trigger mode: <ul style="list-style-type: none"> Control PCP when the /PCON signal is in low level, and the servo reads the contact number. Operate PJOG when /PCON is in high level. 	

 NOTE

Following shall be noted when setting Pn014.1=1.

- Only absolute command (ABS) is supported. When setting the contact as a relative command (REL) or incremental command (INC), the contact will not be executed.
- Automatic loading of the next contact is not supported.
- When /PCON is pulled high during the contact operation, you need to wait for the end of the contact operation before starting PJOG operation.

The attributes in each contact reference are set by the corresponding contact reference with the same meaning. For example, the setting of the attribute parameter PnA64 of PCP[0] is described as follows.

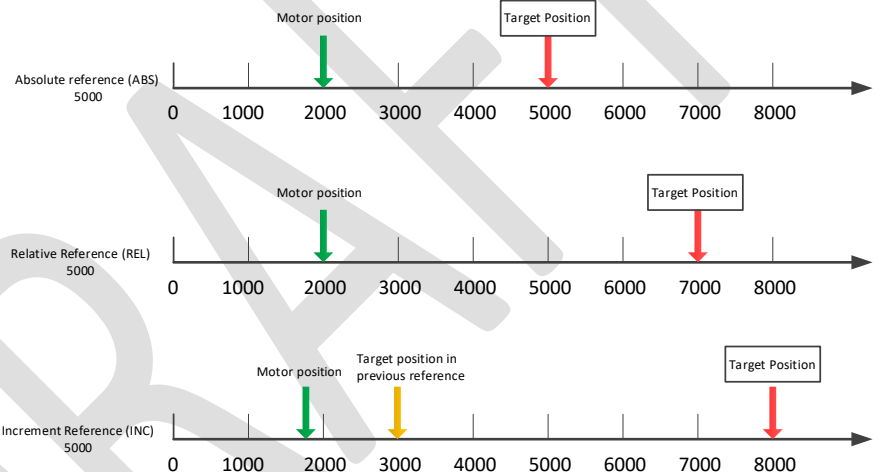
Parameter	Meaning
PnA64.0	<p>CMD: Position Control Reference Mode</p> <p>0: Absolute Command (ABS): The target position is the value of t position command.</p> <p>1: Relative Command (REL): The target position is the motor's current position plus the value of the position command.</p> <p>2: Incremental Command (INC): The target position is the target position of previous position command plus the value of current position command.</p> 
PnA64.1	INS: The current position contact is interrupted when this contact is triggered.
PnA64.2	FLOW: Allow the next command to be loaded after current node is executed. The next command is the contact triggered when current node is running.
PnA64.3	AUTO: Execution by order. After this contact program is completed, the next contact will be executed in order.

INS	FLOW	AUT	Interpretation	Diagram
✓	○	○	<p>With the highest priority.</p> <p>When the attribute of the currently triggered contact is of interrupt, it updates the target position by interrupting the previous contact directly.</p>	
×	✓	○	<p>Priority inferior to Interrupt.</p> <p>When the attribute of the currently triggered contact can be accessed, a new contact is allowed to access upon the execution of this contact and after the delay command is ended.</p> <p>If there is no new insertion, it is judged whether to load the next automatically.</p>	
×	×	✓	<p>With the lowest priority.</p> <p>When there's no contact that needs to be overlapped for current contact, and is not interrupted, the next contact is executed by order.</p> <p>If a new interruptible contact is triggered when this contact is running, it will be interrupted.</p> <p>If a new non-interrupted contact is triggered while the contact is running, the new triggered contact is then discarded.</p>	

INS	FLOW	AUT	Interpretation	Diagram
×	×	×	When current contact is running, no new contact other than Interrupt is accepted. It then judges whether the new contact is triggered until the current contact running is ended.	
	✓, overlap is required if no contact			

5.13.3 Contact Command Model

Position Command

The acceleration/deceleration are trapezoidal according to the given position and the acceleration/deceleration planning path, and can be set separately.

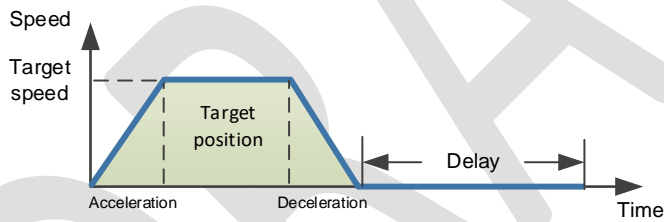

The position planning during Interrupt is to plan the position reference on the basis of the original reference speed.

- The initial speed is in the same direction with the planned position

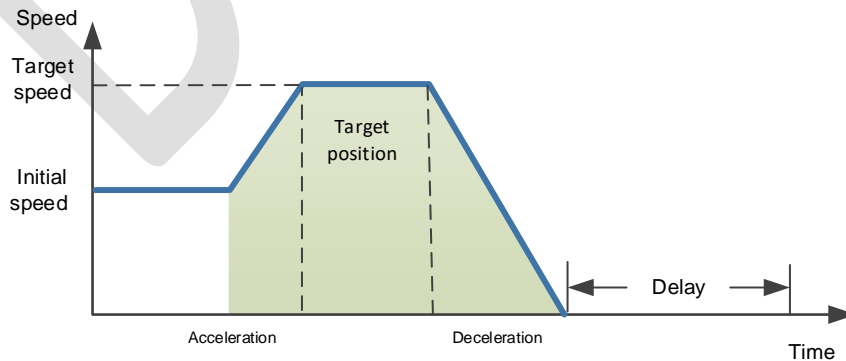

- The initial speed is the direction opposite to the planned position

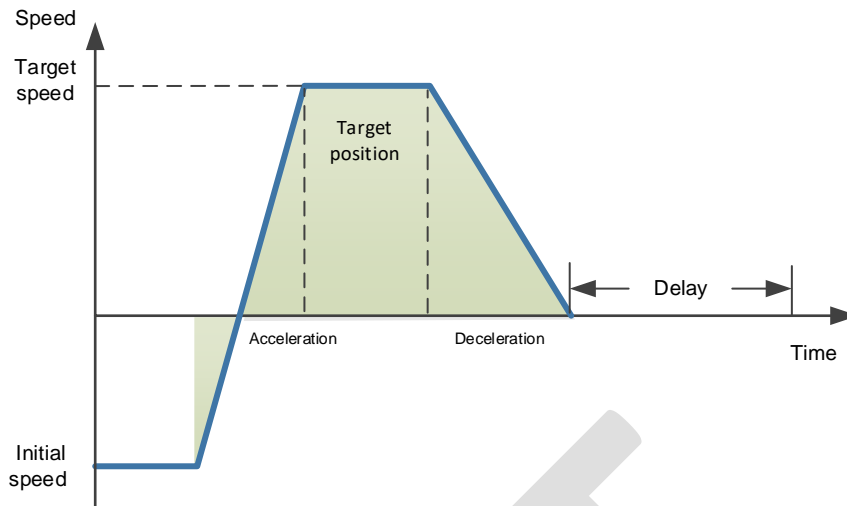

PJOG Command

It is valid under PCP contact control. PJOG can only be performed after the contact operation is ended.

At the same time, the contact cannot be triggered during PJOG operation.

PJOG curve is a trapezoidal, Pn305 is for the speed, Pn306 is for the acceleration, and Pn307 is for the deceleration.

Halt Command

This function allows to stop running through the external input signal STOP.

It is valid under PCP contact control. It can stop operation through the IO port during PJOG and PCP contact operation.

Input STOP signal (active at low level) to stop the current motion state, decelerate the speed to zero as per the deceleration set by Pn719. All control states are cleared after stopping, and cannot be restored to the original motion state. They shall be triggered again.

Number	Name	Range	Unit	Default	When Enabled
Pn324	Time required for trapezoidal deceleration at 1000rpm under indexing function	0 to 10000	ms	100	Immediately

5.13.4 Contact Trigger

The contact uses digital IO port trigger mode, by which users can trigger using the commands of POS0, POS1, POS2, POS3, POS4 and PCON.

The relationships are as defined as follows:

IO trigger mode (/PCON active low)	Contact attribute	Trigger signal
Edge	Absolute command (ABS)	/PCON↓
	Relative command (REL)	/PCON↓
	Relative command (REL)	/PCON↓
	PJOG	/PJOG+ or /PJOG- active when no contact is in operation
Level	Absolute command (ABS)	/PCON active
	Relative command (REL)	Not triggered
	Relative command (REL)	Not triggered
	PJOG	/PCON inactive, /PJOG+ or /PJOG- active

The corresponding IO relationships for each contact number are as listed below:

Position Command	POS4	POS3	POS2	POS1	POS0	Triggered Signal
PCP[0]	0	0	0	0	0	/PCON↓
PCP[1]	0	0	0	0	1	/PCON↓
PCP[2]						/PCON↓ or /PCON active
...						
PCP[30]	1	1	1	1	0	/PCON↓ or /PCON active
PCP[31]	1	1	1	1	1	/PCON↓ or /PCON active

* PCP[0] is available by setting parameter Pn014.2=1; Contact 0 is not executed

5.13.5 Software Limits

Compare the current motor running position of the Un009 with the position limit. It stops running if out of limits, and the servo enters the warning state, the servo is still under excitation status, the panel display shows A.XX in flashing status, and the upper computer can read the current warning number (same address as the alarm number) via Modbus. SoftOt output is available if the IO output signal is configured.

In case of a soft limit, there is no need to manually clear the warning but set the reverse motion command to exit the limit state.

Relevant alarm codes:

Alarm code	Name & sepcification
A.D7	Soft Limit, Forward
A.D8	Soft Limit, Reverse

Parameter	Name & sepcification	Unit	Setting range	Factory default	Re-power on
Pn015	Soft limit enable	-	0x0000-0x0001	0	Required
Pn325	Soft limit position 1	P	- 2,000,000,000-2,000,000,000	2,000,000,000	Not required
Pn326	Soft limit position 2	P	- 2,000,000,000-2,000,000,000	- 2,000,000,000	Not required

When Pn015.0 = 0, the soft limit function is not enabled

When Pn015.0 = 1, the soft limit function is enabled and warning A.D7 occurs if the current position Un009 is greater than the range of Pn325-Pn326. Warning A.D8 occurs if the current position Un009 is less than the range of Pn325- Pn326.

When Pn325 < Pn326, the two values are exchanged and the limit range is Pn326-Pn325.

5.13.6 Partial In-place Output

The Contacts 1 to 7 in-place outputs can be individually monitored

The Pn511 outputs can be configured as follows:

[A]REMOTE0\PCP_COIN0

[B]REMOTE1\PCP_COIN1

[C]REMOTE2\PCP_COIN2

Contact No.	PCP_COIN0	PCP_COIN1	PCP_COIN2	In-place information
xx	0	0	0	Contacts 1 to 7 not in place
PCP[1]	0	0	1	Contact 1 in place
PCP[2]	0	1	0	Contact 2 in place
PCP[3]	0	1	1	Contact 3 in place
PCP[4]	1	0	0	Contact 4 in place
PCP[5]	1	0	1	Contact 5 in place
PCP[6]	1	1	0	Contact 6 in place
PCP[7]	1	1	1	Contact 7 in place

5.13.7 When Overtravel Occurs

During contact operation: When an overtravel occurs, the contact will enter the limit state and exit the contact operation. Un024 is displayed as the current given position.

- If stopping by P-OT, exit the POT by giving a reverse position. The reverse position must be smaller than the current given one.
- If stopping by N-OT, exit NOT by giving a positive position. The positive position must be greater than the current given one.

When PJOG is running:

- PJOG+ can reverse as PJOG- when it stops by encountering P-OT.
- PJOG- can reverse as PJOG- when it stops by encountering N-OT.

5.13.8 Display

Un024 (PCP target position)

- Under non-contact operation state, STOP, PJOG and Servo-off are displayed as the given motor position.
- Under contact operation state, it is displayed as the current target position of PCP.

5.14 Selection of Control Mode Combinations

The servo drive can combine the two control modes and switch between them. The control mode combinations can be selected by setting "4" to "B" in Pn005.1.

Parameter	Setting	Control Mode Combinations	When Enabled
Pn005.1	4	Speed control (contact reference) ↔ speed control (analog reference)	After restart
	5	Speed control (contact reference) ↔ position control (pulse train reference)	
	6	Speed control (contact reference) ↔ torque control	

Parameter	Setting	Control Mode Combinations	When Enabled
	7	Position control (pulse train reference) ↔ speed control (analog reference)	
	8	Position control (pulse train reference) ↔ torque control	
	9	Torque control ↔ Speed control (analog reference)	
	A	Speed control (analog reference) ↔ zero clamp control	
	B	Position control (pulse train reference) ↔ Position control (pulse prohibited)	

When Pn005.1=4, 5 and 6

Switch the control mode by using /P-CON, /PCL and /NCL signals.

Signal			Running Speed			Motor Traveling Direction
/P-CON	/PCL	/NCL	Pn005.1 = 4	Pn005.1 = 5	Pn005.1 = 6	
OFF	OFF	OFF	Speed Control	Position Control	Torque Control	Forward
	OFF	ON	Run at internally set speed 1 as set by Pn316.			
	ON	OFF	Run at internally set speed 2 as set by Pn317.			
	ON	ON	Run at internally set speed 3 as set by Pn318.			
ON	OFF	OFF	Run at internally set speed 4 as set by Pn319.			Reverse
	OFF	ON	Run at internally set speed 5 as set by Pn320.			
	ON	OFF	Run at internally set speed 6 as set by Pn321.			
	ON	ON	Run at internally set speed 7 as set by Pn322.			

[Example] The running example of Pn005.1 = 5 [Speed control (contact reference) ↔ Position control (pulse train reference)] is detailed as follows.

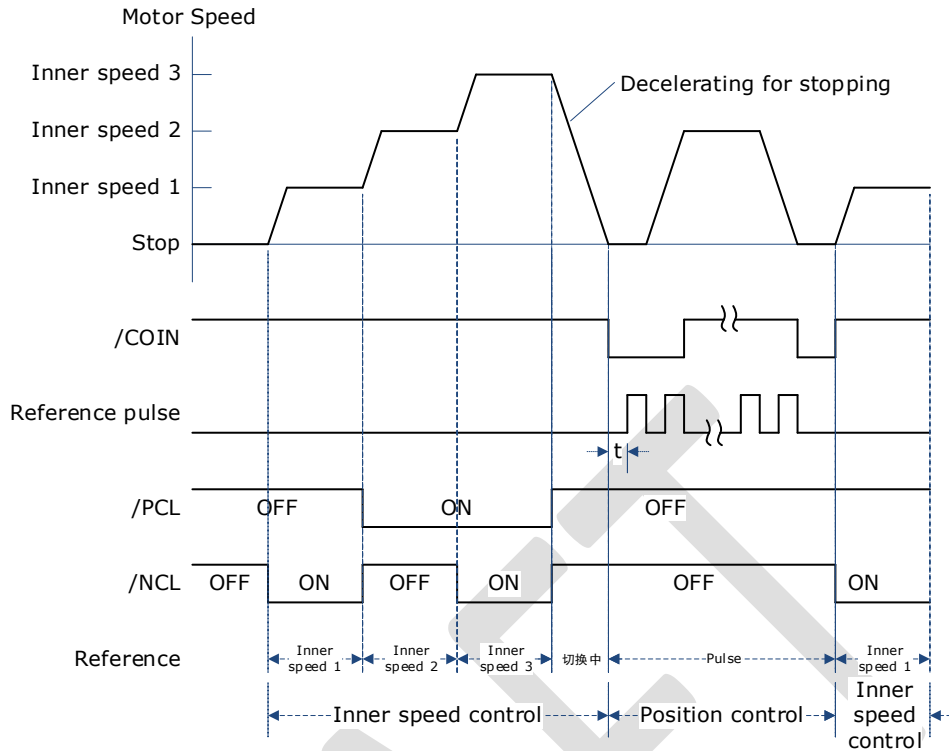

NOTE

- The value of t is not affected by the use of the soft boot feature. Reads of /PCL and /NCL can result in a maximum delay of 2ms.
- The switch of the speed control (contact command) → position control (pulse column command) switches to position control after the motor deceleration has stopped during the deceleration time set by Pn307.

When Pn005.1=7, 8 and 9

Switch control mode using /P-CON.

Type	Signal Name	Pin Number	Setting	Pn005.1=7	Pn005.1=8	Pn005.1=9
Input	/P-CON	CN1-15	ON	Speed control	Torque control	Speed control
			OFF	Position control	Position control	Torque control

When Pn005.1=A and B

Switch control modes using /P-CON.

Type	Signal Name	Pin Number	Setting	Pn005.1=A	Pn005.1=B
Input	/P-CON	CN1-15	ON	Speed control with zero clamp function	Position control with reference pulse prohibition
			OFF	speed control	Position control

5.15 Torque Limit

The servo drive provides the following three methods for limiting output torque to protect the machine.

Limit Method	Outline
Internal Torque Limits	Torque limiting through the parameters.
External Torque Limits	The torque is limited with an input signal from the host station.
Torque limit of analog reference	Torque limiting by analog reference

NOTE

If you set a value that exceeds the maximum torque of the Motor, the torque will be limited to the maximum torque of the Motor.

5.15.1 Internal Torque Limits

This function limits the maximum output torque through parameters Pn401 and Pn402.

Parameter	Name	Range	Unit	Default	When Enabled
Pn401	Forward Internal Torque Limit	0 to 350	%	300	Immediately
Pn402	Reverse Internal Torque Limit	0 to 350	%	300	Immediately

[Note] The setting unit is the percentage relative to the motor's rated torque.

Figure below shows a comparison of waveform curves with internal torque and without torque limit:

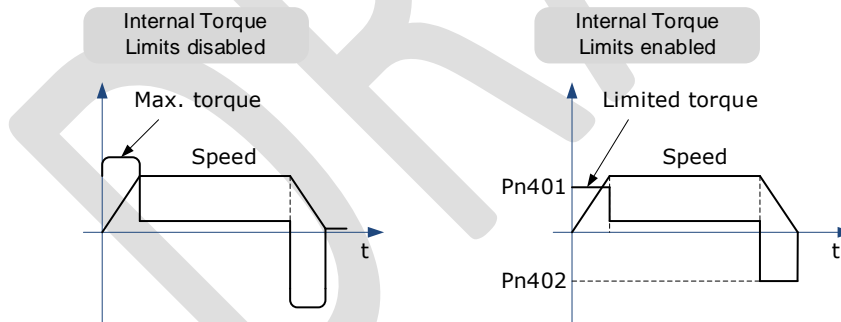

[Note] If the setting of Pn401 or Pn402 is too low, the torque may be insufficient for acceleration or deceleration of the Motor.

5.15.2 External Torque Limits

This function limits the torque through the input signal of the upper controller when the torque to be limited at specific times during machine operation. It can be used to push to stop the action or to hold operations for robot workpieces.

Input Signal

The input signals to enable the external torque limits are listed in table below.

Type	Signal Name	Connector Pin Number	Signal State	Meaning
Input	/P-CL	CN1-41	ON	Turn ON the forward external torque limit. [Limit value: Pn403]
			OFF	Turn OFF the forward external torque limit. [Limit value: Pn401]
Input	/NCL	CN1-42	ON	Turn ON the reverse external torque limit. [Limit value: Pn404]
			OFF	Turn OFF the reverse external torque limit. [Limit value: Pn402]

Related Parameters

The related parameters of external torque limit are as follows.

Parameter	Name	Range	Unit	Default	When Enabled
Pn401	Forward Internal Torque Limit	0 to 400	%	350	Immediately
Pn402	Reverse Internal Torque Limit	0 to 400	%	350	Immediately
Pn403	Forward External Torque Limit	0 to 400	%	100	Immediately
Pn404	Reverse External Torque Limit	0 to 400	%	100	Immediately

[Note] The setting unit is the percentage relative to the motor's rated torque.

If the setting values of Pn401, Pn402, Pn403 and Pn404 are too low, the torque may be insufficient for motor acceleration/deceleration.

Changes in the Output Torque for External Torque Limits

In the following figure, when setting Pn001.0=0 (under the forward reference, the incremental encoder is used in the positive counting direction), it indicates to set the internal torque limit as 300% of output torque (Pn401 and Pn402 are both 300%).

/PCL	/NCL	Diagram
OFF [H Level]	OFF [H Level]	

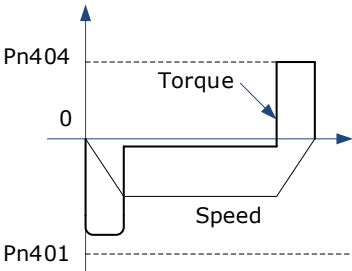
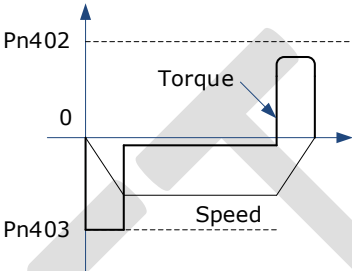
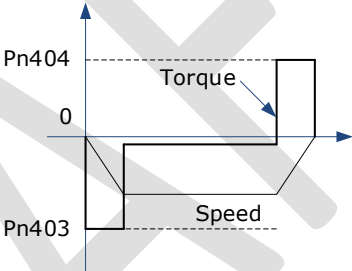
/PCL	/NCL	Diagram
OFF [H Level]	ON [L Level]	
ON [L Level]	OFF [H Level]	
ON [L Level]	ON [L Level]	

5.15.3 Torque Limiting Using an Analog Reference

This function uses TREF (CN1-26, -27) as analog reference input terminal so as to limit the torque arbitrarily.

This limit method can only be used in speed control or position control, but be invalid in torque control.

Parameter	Setting	Meaning	When Enabled
Pn001.2	1	Use the TREF terminal as the input terminal of external torque limit.	After restart

Figure below is the block diagram under speed control.

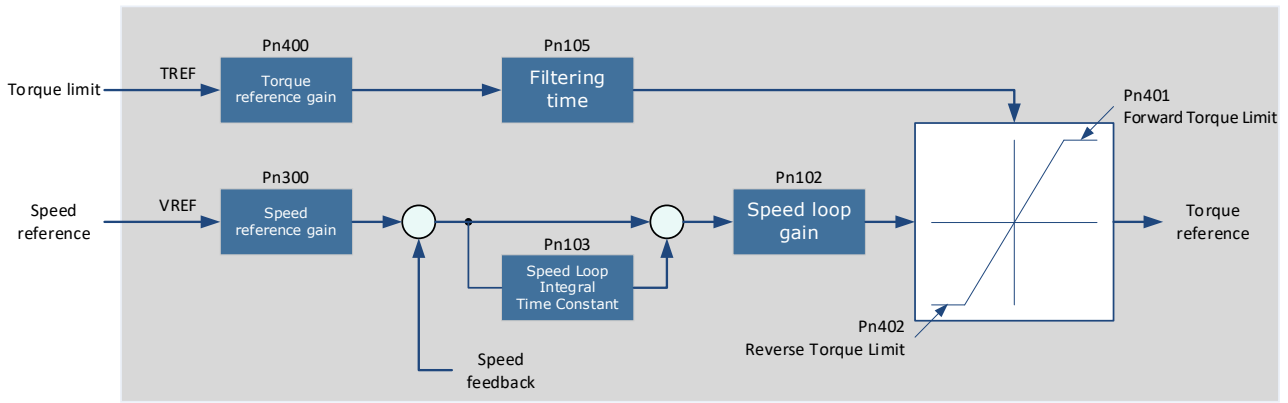

[Note] There is no issue with input voltage polarity of the analog voltage reference for torque limiting. The absolute values of both + and - voltages are input, and a torque limit value corresponding to that absolute value is applied in the forward or reverse direction.

Input Signal

The input signals when the torque limiting using an analog reference is made are as follows.

Type	Signal Name	Connector Pin Number	Meaning
Input	TREF+	CN1-26	Input signal of torque reference
	TREF-	CN1-27	

Related Parameters

The parameters related to the torque limiting using an analog reference are as follows.

Number	Name	Range	Unit	Default	When Enabled
Pn401	Forward Internal Torque Limit	0 to 400	%	350	Immediately
Pn402	Reverse Internal Torque Limit	0 to 400	%	300	Immediately
Pn400	Analog Torque Reference Gain	10 to 100	0.1V/100%	33	Immediately
Pn105	Torque Reference Filter Time Constant	0 to 2500	0.01ms	50	Immediately

5.15.4 Torque Limit Confirmation Signals

Output signal indicating the status of motor output torque limit is shown below.

Type	Signal Name	Connector Pin Number	Output State	Meaning
Input	/CLT	Allocated by Pn511	ON	Motor output torque is being limited.
			OFF	Output torque is not being limited.

For ways to allocate output signals, see "0 Output Signal Allocation".

5.16 Homing

5.16.1 Function Overview

The Storing Origin function is available after homing.

User can choose whether to home directly after power-up.

User may choose whether to continue homing after a limit or to enter a limit state.

Multiple homing modes are supported.

Storing Origin:

Clear origin data when Pn689.2 = 0.

When Pn689.2 = 1, the Storing Origin is performed after homing is completed, which stores the current single-turn position and the multi-turn position information that can be viewed via Un035 and Un036 respectively. (The origin is stored in parameters Pn694 and Pn695, and will not be displayed). When powering up again, there is no need to perform the homing operation again. The current position of the motor (absolute position with respect to the origin position) can be updated by calculating from the current multi-turn position and single-turn position of the motor as well as the stored position information, and homing done signal is then output. The current position can be viewed via Un009.

Warning A.D9 occurs if the Storing Origin function is switched on and succeeded or the origin stored is lost due to no homing operation.

Homing parameters:

User parameters	Meaning
Pn689	<p>b.□□□ A</p> <p>0: Switch off the Homing function 1: Enable the Homing function, which can be triggered by the rising edge of the SHOM signal, or be automatically homed after powering up.</p>
	<p>b.□□B □</p> <p>0: The first time Servo-on takes effect, no automatic homing is performed and a SHOM signal is required to trigger the homing operation. 1: The first time Servo-on takes effect, the automatic homing is performed without the need for a SHOM signal trigger.</p>
	<p>b.□C□ □</p> <p>0: No origin is stored after homing, and the data originally stored in Pn694 and Pn695 is reset. 1: Origin is stored after homing. When the encoder has a multi-turn position (Pn002.2 = 0), the current position of the motor is automatically updated each time the drive is re-powered and the homing done signal is output. If a multi-turn information error alarm such as encoder A47 occurs, the data stored in Pn694 and Pn695 is cleared and the homing done signal is not output.</p>
	<p>b.D□□ □</p> <p>0: In the process of searching for the trigger point, return to the limit and continue to make homing 1: Homing modes 1-6, search for trigger point and stop when it meets limit, and then enter limit state</p>



说明

- Applicable control mode: position control
- Homing operation can only be enabled when /COIN is ON.
- Position control function is invalid during homing process.
- After changing these parameters, turn the power supply ON again to enable the new settings.
- The input connector pin numbers can be assigned to signals SHOM and ORG by means of user parameters.
- After servo is turned ON, it is impossible to start homing under overtravel state (when P-OT/N-OT is enabled).

5.16.2 Related Parameters

Pn685	Speed of finding reference point (hitting the origin signal ORG)			
	Range	Unit	Default	Re-powered or not
	0~3000	rpm	1500	Not required
Pn686	Speed of finding reference point (leaving the origin signal ORG)			
	Range	Unit	Default	Re-powered or not
	0~200	rpm	30	Not required
Pn690	Number of homing offset pulses When homing mode is 7 and 9 (in the case of positive limit deceleration), the positive setting of the offset pulse number is invalid. When homing mode is 8 and 10 (in the case of reverse limit deceleration), the reverse setting of the offset pulse number is invalid.			
	Range	Unit	Default	Re-powered or not
	-9999~9999	10000 Pulse	0	Not required
Pn691	Number of homing offset pulses When homing mode is 7 and 9 (in the case of positive limit deceleration), the positive setting of the offset pulse number is invalid. When homing mode is 8 and 10 (in the case of reverse limit deceleration), the reverse setting of the offset pulse number is invalid.			
	Range	Unit	Default	Re-powered or not
	-9999~9999	1Pulse	0	Not required
Pn692	The homing mode is valid after re-powering on.			
Pn693	Homing acceleration, time taken to accelerate to 1,000rpm, in ms			



说明

- When homing mode is 7 and 9 (in the case of positive limit deceleration), the positive setting of the offset pulse number is invalid.
- When homing mode is 8 and 10 (in the case of reverse limit deceleration), the reverse setting of the offset pulse number is invalid.

5.16.3 Selection of Homing Modes

Select homing mode using Pn692. The Homing mode is valid after re-powering on.

Parameter	Setting	Meaning	When Enabled
Pn692	0	Use current position as the origin	After

Parameter	Setting	Meaning	When Enabled
	1	Forward homing, and use deceleration point and origin as the ORG switch	restart
	2	Reverse homing, and use deceleration point and origin as the ORG switch	
	3	Forward homing, and use the deceleration point as the ORG switch, and the origin as the motor's Z signal	
	4	Reverse homing, and use the deceleration point as the ORG switch, and the origin as the motor's Z signal	
	5	Forward homing, and use the deceleration point and origin as the motor's Z signal	
	6	Reverse homing, and use deceleration point and origin as the motor's Z signal	
	7	Forward homing, use the deceleration point and origin as the overtravel switches	
	8	Reverse homing, and use deceleration point and origin as the overtravel switches	
	9	Forward homing, and use the deceleration point as an overtravel switch, and the origin as the motor's Z signal	
	10	Reverse homing, and use the deceleration point as an overtravel switch, and the origin as the motor's Z signal	
	11	Power-up and run to home; only applicable when Pn005.1 = 1 and for position control (pulse train command)	

5.16.4 Allocating Homing Signals

SHOM and ORG signals need to be allocated before homing operation, which can be set via Pn509 or Pn510.

Type	Signal Name	Connector Pin Number	Signal State	Meaning
Input	SHOM	Allocated by Pn509 or Pn510	ON= ↑ (rising edge)	Start homing operation.
			OFF= Non-rising edge signal	Homing operation is not executed.
Input	ORG	Allocated by Pn509 or Pn510	ON=High level	Reference position of homing point is valid
			OFF=Low level	Reference position of homing point is invalid

Set the output signal (/HOME) after homing via Pn511.

Setting	Connector Pin Number		Meaning
	+ Terminal	- Terminal	
Pn511.0=8	CN1-11	CN1-12	The signal is output from output terminal CN1-11,12.
Pn511.1=8	CN1-5	CN1-6	The signal is output from output terminal CN1-5,6.
Pn511.2=8	CN1-9	CN1-10	The signal is output from output terminal CN1-9,10.

[Note] HOME signal is only enabled at low level (ON).

5.16.5 Homing Timing Sequence

Homing modes 1 and 2, using deceleration point and origin as ORG switch

Hit the deceleration signal (ORG rising edge) before encountering the limit signal.

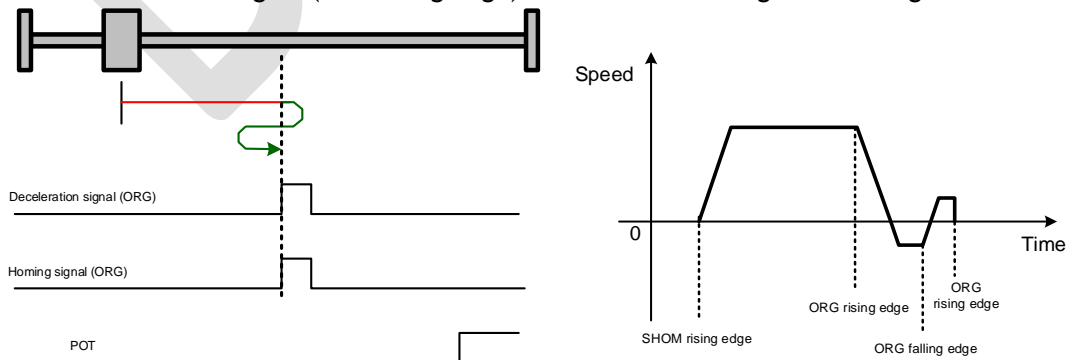

Hit the limit signal before encountering deceleration signal (ORG rising edge).

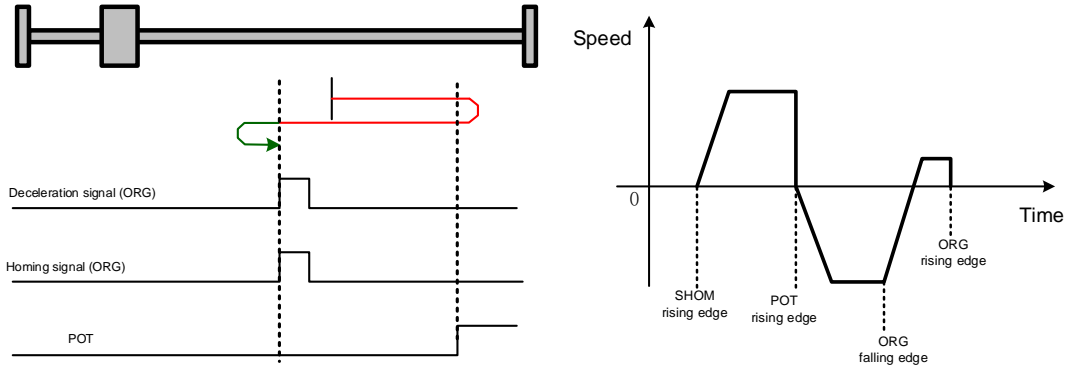

Homing modes 3 and 4, using deceleration point as ORG switch, and origin as Motor's Z signal

Hit the deceleration signal (ORG rising edge) before encountering the limit signal.

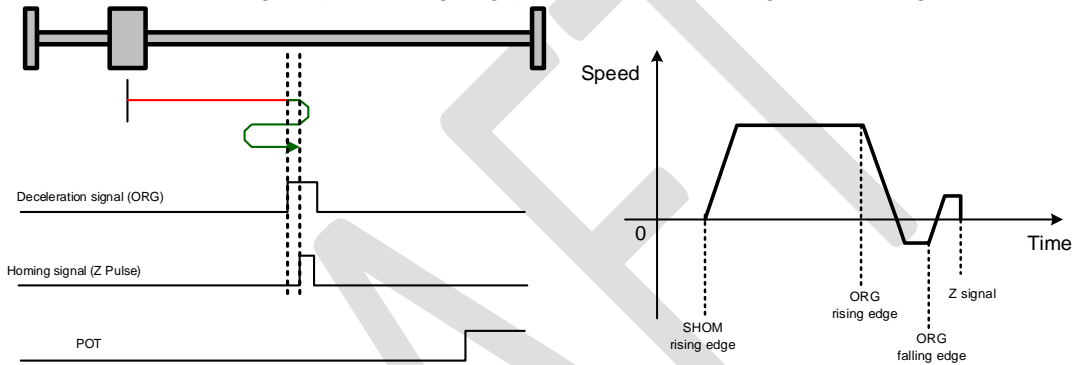

Hit the limit signal before encountering deceleration signal (ORG rising edge).

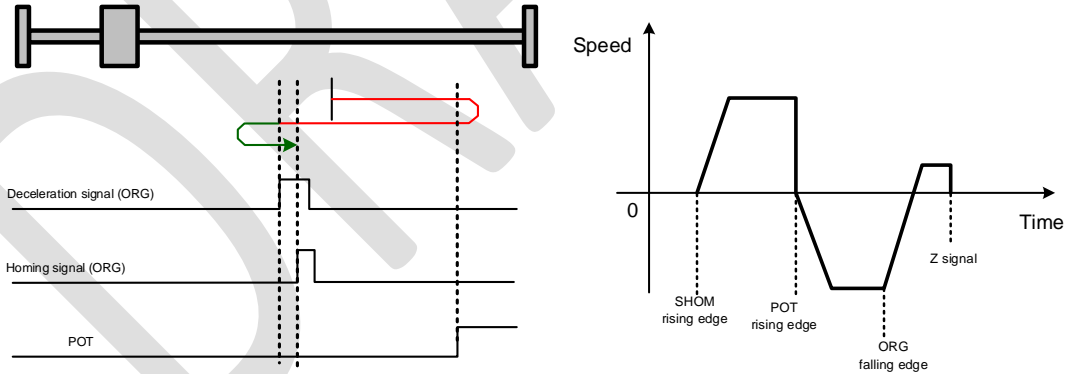

Homing modes 5 and 6, using origin as motor's Z signal

Hit the deceleration signal (Z signal rising edge) before encountering the limit signal.

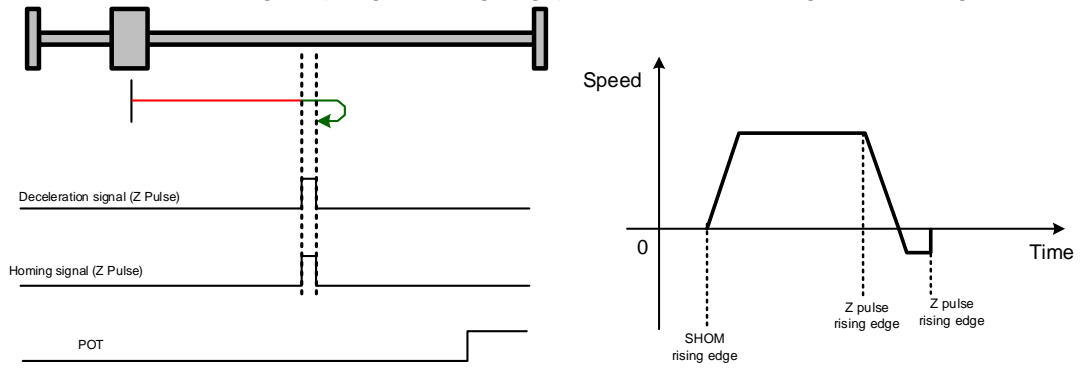

Hit the limit signal before encountering deceleration signal (Z signal rising edge).

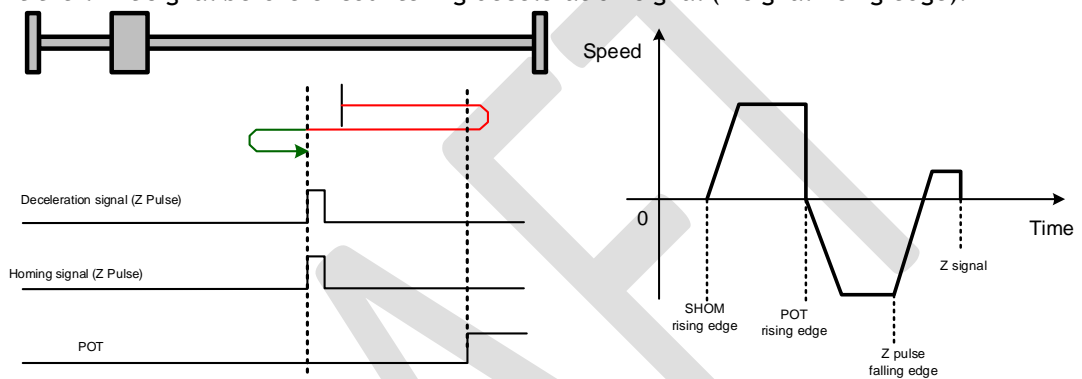

Homing modes 7 and 8, using deceleration point and origin as overtravel switch

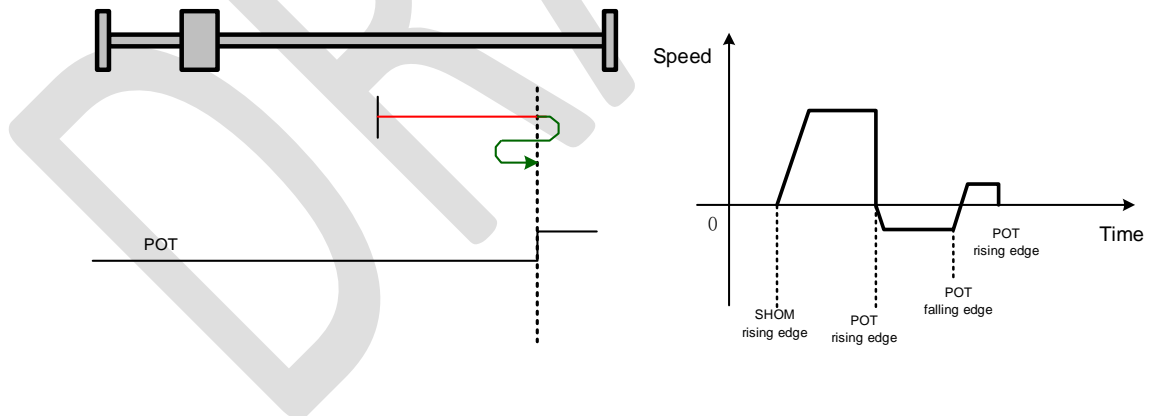

Homing modes 9 and 0, using deceleration point as overtravel switch, and origin as motor's Z signal

Homing finding point does not return when hitting the falling edge of OT.

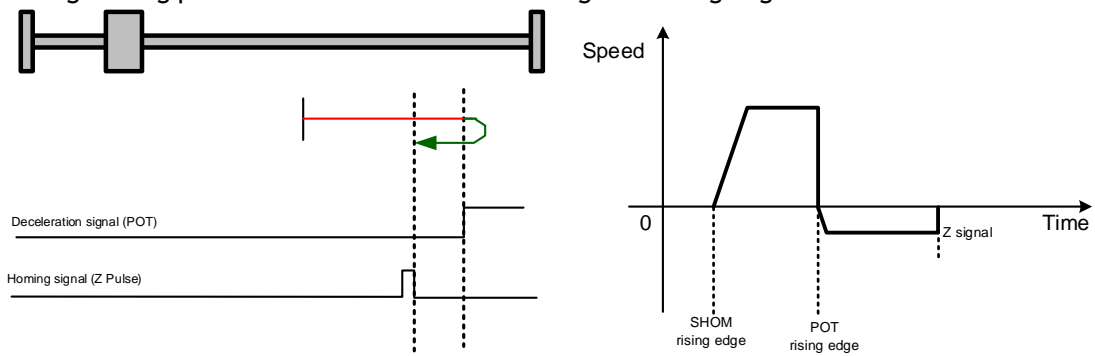

5.17 Other Output Signals

5.17.1 Alarm Output Signal (/ALM)

The servo drive outputs an alarm output signal (/ALM) when it detects an alarm.

Connection of Alarm Output Signal



IMPORTANT

The external circuit formed by /ALM must satisfy following conditions: the main circuit power supply of the servo drive is turned OFF through the signal output.

The following diagram shows the right way to connect the Alarm Output Signal:

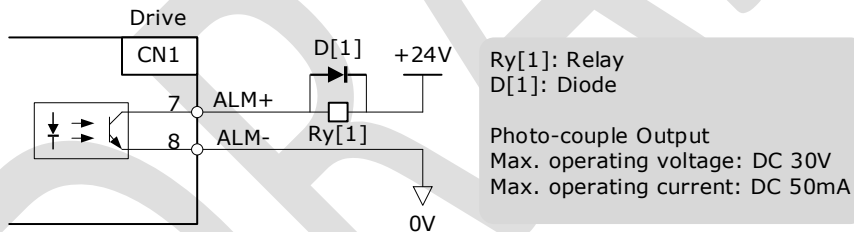

An external +24V I/O power supply is required.

Type	Signal Name	Connector Pin Number	Signal State	Meaning
Output	/ALM	CN1-7, 8	ON	Servo drive is operating normally.
			OFF	Servo drive is in alarm status

Ways to Reset Alarm

When “servo alarm (ALM)” happens, always remove alarm reasons first, and then turn the input signal “/ALM-RST” to ON position to reset alarm status.

Type	Signal Name	Connector Pin Number	Meaning
Input	ALM-RST	CN1-39	Alarm resets

**IMPORTANT**

Be sure to check the cause of the alarm before alarm reset.
For the alarm troubleshooting, refer to "10.2 Troubleshooting".

NOTE

- Some alarms may not be reset by the ALM-RST signal. In this case, reset after cutting off the control power.
- User may also try to reset the current alarm by pressing the [◀] key on the operation panel.

5.17.2 Rotation Detection Output Signal (/TGON)

/TGON is output when the motor is currently operating above the setting set in parameter Pn503.

Signal Specification

Type	Signal Name	Connector Pin Number	Signal State	Meaning
Output	/TGON	CN1-5, 6	ON	Motor is running at a speed above the value set in Pn503.
			OFF	Motor is running at a speed lower than the value set in Pn503.

Related Parameters

Number	Name	Range	Unit	Default	When Enabled
Pn503	Detection Speed	0 to 3000	rpm	20	Immediately

5.17.3 Servo Ready (/S-RDY) Output Signal

The servo drive outputs the servo READY signal (/S-RDY) after receiving servo ON (S-ON) signal. The signal is output under the following conditions:

- The main circuit power supply is ON.
- No alarm occurs.

The specification of signal is as follows:

Type	Signal Name	Connector Pin Number	Signal State	Meaning
Output	/S-RDY	CN1-9, 10	ON	Status of the servo ON (S-ON) signal can be received.
			OFF	Status of the servo ON (S-ON) signal cannot be received.

Chapter 6 CANopen Communication

6.1 Wiring and Connection

Connection diagram

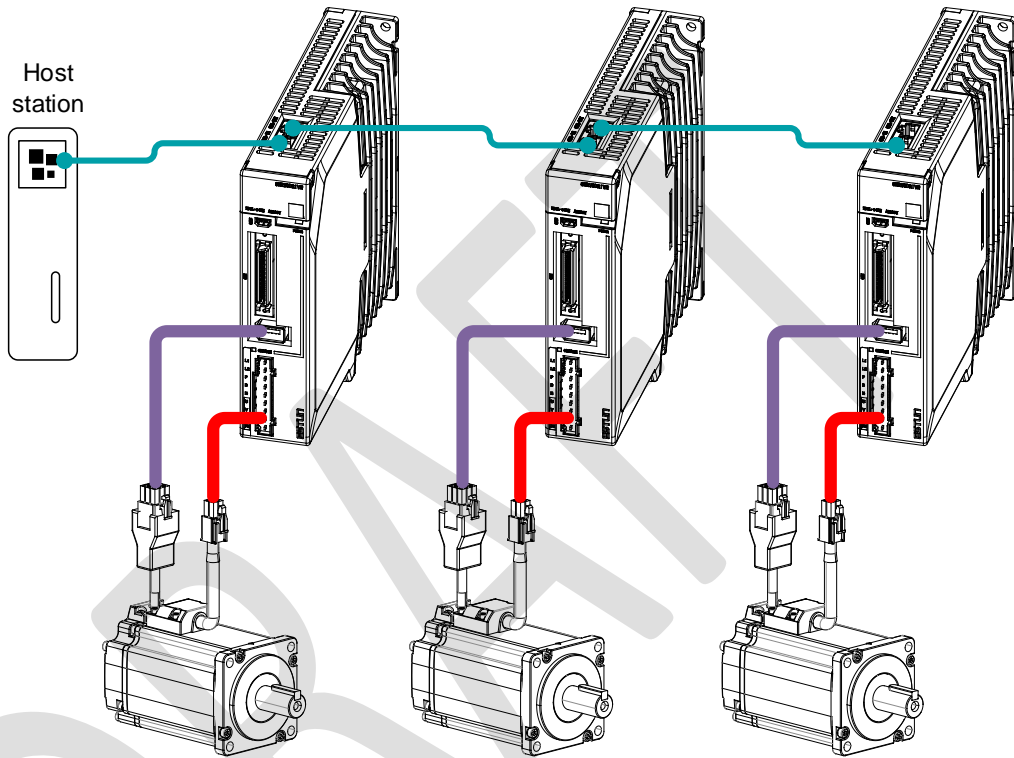

Terminal arrangement

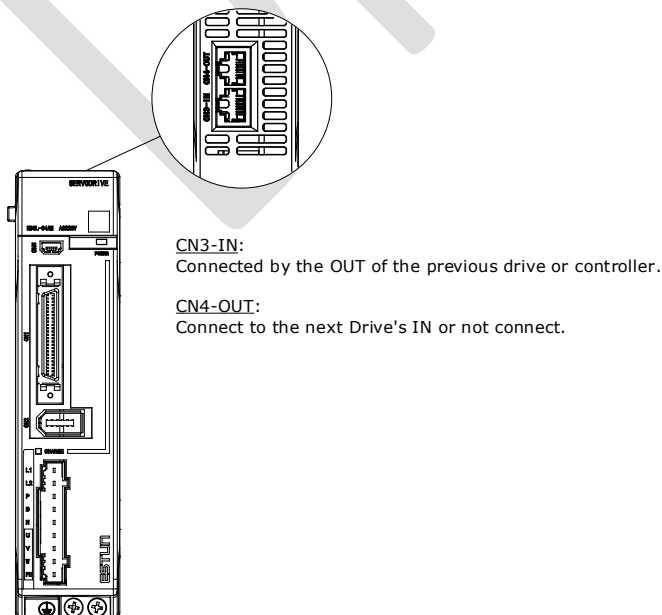

Signal Definition

The external communication connection terminals (CN3-IN and CN4-OUT) are of RJ45 connectors. The interface line as the master or controller is connected from CN3-IN, and CN4-OUT is connected to the CN3-IN terminal of next drive (slave).

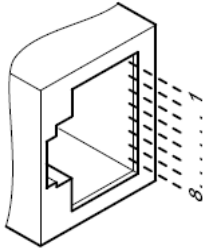
Connector	Pin	Definition	Description
	1	–	Reserved
	2	–	
	3	RS485+	RS-485 communication terminal +
	4	GNDW	Signal GND
	5	GNDW	
	6	RS485-	RS-485 communication terminal -
	7	CANH	CAN communication terminal
	8	CANL	
	Housing	FG	Shielded wire is connected to the housing

[Note] The signal definitions of CN3-IN and CN4-OUT are the same.

Wiring Instructions

When wiring the CANopen communication, following precautions shall be taken.

- Do not short connect pin 1 and pin 2.
- Use UTPs (at least 2 pairs) with shielding layer.
One pair of UTPs is connected to CANL and CANH; the other is connected to ISO_GND.
- The shielding layer is generally grounded reliably at a single point.
- To prevent signal reflection, it is recommended to connect two 120Ω (1%, 1/4W) terminal matched resistors at both ends of the bus.
- It is recommended that the CAN bus networking node is ≤ 16 .

The wiring diagram is shown below.

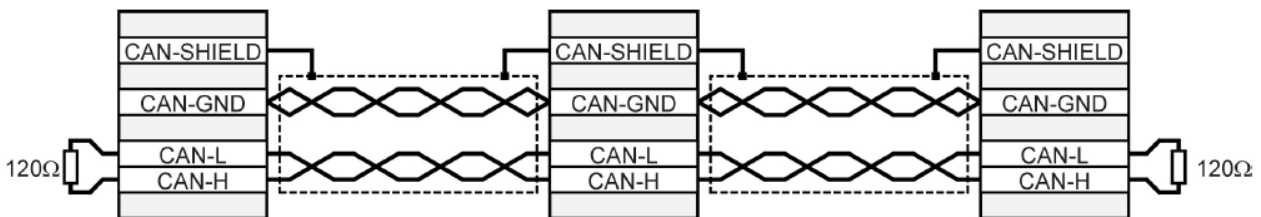

6.2 CANopen Overview

6.2.1 CAN Identifier List

Object	COB-ID bit10tobit7	COB-ID (Hexadecimal)	Index in OD
NMT	0000	000 _h	–
SYNC	0001	080 _h	1005 _h 、 1006 _h 、 1007 _h
TIME STAMP	0010	100 _h	1012 _h 、 1013 _h
EMCY	0001	081 _h to 0FF _h	1024 _h 、 1015 _h
PDO1 (transmit)	0011	181 _h to 1FF _h	1800 _h
PDO1 (receive)	0100	201 _h to 27F _h	1400 _h
PDO2 (transmit)	0101	281 _h to 2FF _h	1801 _h
PDO2 (receive)	0110	301 _h to 37F _h	1401 _h
PDO3 (transmit)	0111	381 _h to 3FF _h	1802 _h
PDO3 (receive)	1000	401 _h to 47F _h	1402 _h
PDO4 (transmit)	1001	481 _h to 4FF _h	1803 _h
PDO4 (receive)	1010	501 _h to 57F _h	1403 _h
SDO (transmit)	1011	581 _h to 5FF _h	1200 _h
SDO (receive)	1100	601 _h to 67F _h	1200 _h
Heartbeat	1110	701 _h to 77F _h	1016 _h 、 1017 _h

6.2.2 Service Data Objects (SDO)

SDO is used to visit the object dictionary of a device. Visitor is called client. The CANopen device whose object dictionary is visited and required to supply the asked service is called server. CANopen messages from a client and servo all contain 8 bits (not all of them are meaningful). A request from a client must be confirmed by a server.

There are 2 method of transferring SDO:

- Expedited transfer: contains 4 bytes at maximum
- Segmented transfer: contains more than 4 bytes

Basic structure of SDO:

Byte0	Byte1 to Byte2	Byte3	Byte4 to Byte7
SDO	Object index	Object sub-index	Data

SDO read/write structure:

SDO message format for parameter read/write operation:

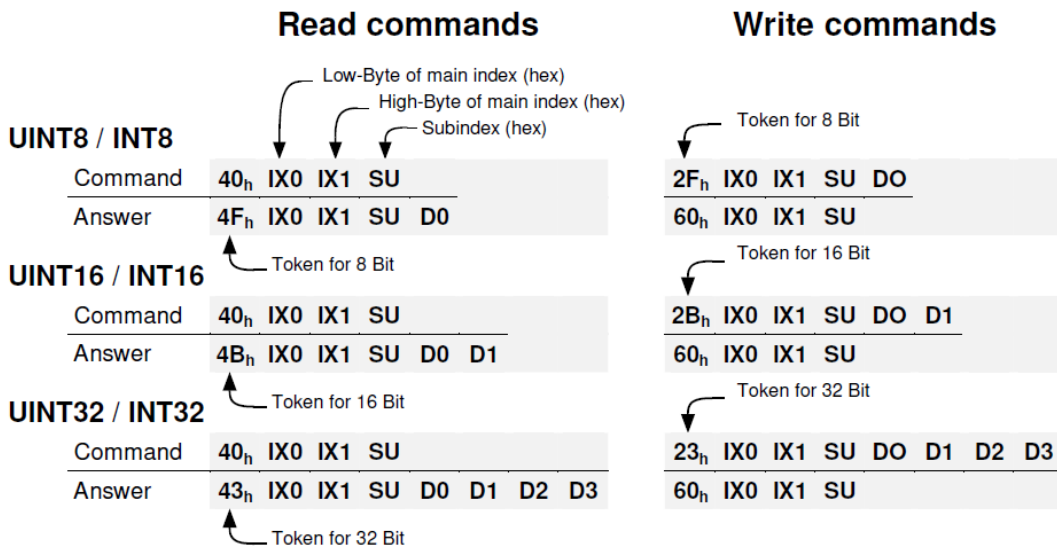

For example:

<p>UINT8 / INT8</p> <p>Reading of Obj. 6061_00_h Returning data: 01_h</p> <p>Command: 40_h 61_h 60_h 00_h</p> <p>Answer: 4F_h 61_h 60_h 00_h 01_h</p>	<p>Writing of Obj. 1401_02_h Data: EF_h</p> <p>2F_h 01_h 14_h 02_h EF_h</p> <p>60_h 01_h 14_h 02_h</p>
<p>UINT16 / INT16</p> <p>Reading of Obj. 6041_00_h Returning data: 1234_h</p> <p>Command: 40_h 41_h 60_h 00_h</p> <p>Answer: 4B_h 41_h 60_h 00_h 34_h 12_h</p>	<p>Writing of Obj. 6040_00_h Data: 03E8_h</p> <p>2B_h 40_h 60_h 00_h E8_h 03_h</p> <p>60_h 40_h 60_h 00_h</p>
<p>UINT32 / INT32</p> <p>Reading of Obj. 6093_01_h Returning data: 12345678_h</p> <p>Command: 40_h 93_h 60_h 01_h</p> <p>Answer: 43_h 93_h 60_h 01_h 78_h 56_h 34_h 12_h</p>	<p>Writing of Obj. 6093_01_h Data: 12345678_h</p> <p>23_h 93_h 60_h 01_h 78_h 56_h 34_h 12_h</p> <p>60_h 93_h 60_h 01_h</p>

Format of SDO read/write error message:

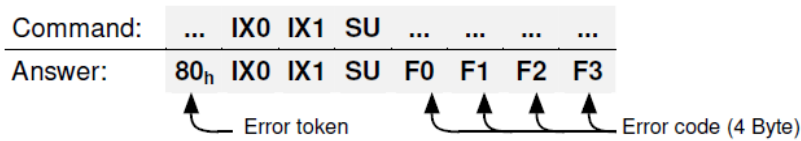

Error code is defined as follows:

Error code F3 F2 F1 F0	Description
05 03 00 00 _h	Toggle bit not alternated
05 04 00 01 _h	Client / server command specifier not valid or unknown
06 01 00 00 _h	Unsupported access to an object
06 01 00 01 _h	Attempt to read a write only object
06 01 00 02 _h	Attempt to write a read only object
06 02 00 00 _h	Object does not exist in the object dictionary
06 04 00 41 _h	Object cannot be mapped to the PDO
06 04 00 42 _h	The number and length of the objects to be mapped would exceed PDO length
06 04 00 47 _h	General internal incompatibility in the device
06 07 00 10 _h	Data type does not match, length of service parameter does not match
06 07 00 12 _h	Data type does not match, length of service parameter too high
06 07 00 13 _h	Data type does not match, length of service parameter too low
06 09 00 11 _h	Sub-index does not exist
06 04 00 43 _h	General parameter incompatibility
06 06 00 00 _h	Access failed due to an hardware error ^{*1)}
06 09 00 30 _h	Value range of parameter exceeded
06 09 00 31 _h	Value of parameter written too high
06 09 00 32 _h	Value of parameter written too low
06 09 00 36 _h	Maximum value is less than minimum value
08 00 00 20 _h	Data cannot be transferred or stored to the application ^{*1)}
08 00 00 21 _h	Data cannot be transferred or stored to the application because of local control
08 00 00 22 _h	Data cannot be transferred or stored to the application because of the present device state ^{*3)}
08 00 00 23 _h	No Object Dictionary is present ^{*2)}

6.2.3 Process Data Objects (PDO)

PDO is applied to transferring real time data which will be conveyed from a producer to one or multiple clients. Data transferring will be limited to 1 to 8 bytes. There is no hand-shake restriction in PDO communication, which means data has been redefined, so clients could process the received data for vary short time. PDO content will be only defined by its CAN ID, assuming producers and clients know PDO content from its CAN ID.

2 objects in object dictionary are used for each PDO.

- PDO communication parameter: It contains COB-ID, transferring type, restriction time and cycle of timer used by PDO.
- PDO mapping parameter: It contains a list of objects in the object dictionary. These objects are mapped into PDO, includes their data length in bits. Producers and clients must know this mapping to explain the content of PDO.

The content of PDO's message is predefined or configured when the network initializes. Mapping application object into PDO is described in object dictionary. If a device (producer and client) support dynamic mapping, SDO could be used to configure PDO's mapping parameter. Our servo drive supports dynamic PDO mapping. There are 2 rules for PDO mapping to follow:

- Each PDO could be mapped into 4 objects.
- The length of each PDO will be no more than 64 bits.

PDO mapping process

1. Set the sub-index of PDO coordinated mapping parameter (e.g. 1600_h or 1A00_h) as o.

2. Revise the sub-index from 1 to 4 of PDO coordinated mapping parameter (e.g. 1600_h or 1A00_h).
3. Set the sub-index 0 of PDO coordinated mapping parameter (e.g. 1600_h or 1A00_h) as legal Number (number of PDO's mapping objects)
4. PDO mapping completed.

Ways to transmit PDO

- Synchronous (synchronization by receiving SYNC object)
Cycle: Transmission triggered after every 1 to 240 SYNC messages.
- Asynchronous
Transmission triggered by special object event regulated in sub-object protocol.

Definition of transmission type of PDO

Transmission Type	Description	PDO Type
0	Reserved	–
1to240	SYNC: It represents the number of SYNC objects between 2 PDOs.	TPDO/RPDO
240to253	Reserved	
254	Asynchronous: If the content of PDO has changed, PDO transmission will be triggered.	TPDO
255	Asynchronous: The content of PDO will be periodically updated and transmitted.	TPDO/RPDO

One PDO could set a frozen time which is the shortest interval time between 2 continuous PDO. It could prevent the bus from being occupied by amount of data with high priority. Frozen time is defined by 16 bit unsigned integer number and its unit is 100us

One PDO could set a timing period. When the regulated time is violated, a PDO transmit could be triggered without a trigger bit. Object timing period is defined as 16 bit unsigned integer and its unit is 1ms.

PDO mapping example

Map the 3 objects to PDO1 (transmit). PDO1 (transmit) is required to be asynchronous periodic type with period time as much as 10ms and frozen time as much as 2ms.

Object	Index – Sub-index	Description
statusword	6041 _h - 00 _h	Status word
modes_of_operation_display	6061 _h - 00 _h	Practical operational mode
Position_Actual_Value	6064 _h - 00 _h	Practical position

1. Clear number_of_mapped_objects
number_of_mapped_objects(1A00_h: 00_h)= 0
 2. Set the parameter for mapping objects
 Index =6041_h Subin. = 00_h Length = 10_h ⇒ 1st_mapped_object(1A00_h: 01_h)= 60410010_h
 Index =6061_h Subin. = 00_h Length = 08_h ⇒ 2st_mapped_object(1A00_h: 02_h)= 60610008_h
 Index =60FD_h Subin. = 00_h Length = 20_h ⇒ 3st_mapped_object(1A00_h: 03_h) = 60FD0020_h
 3. Set number_of_mapped_objects
number_of_mapped_objects(1A00_h: 00_h)= 3
 4. Set PDO communication parameter

PDO1 (transmit) is asynchronous periodical type ⇒ transmit_type (1800 h: 02 h)= FF h
 Frozen time 2ms(20×100us) ⇒ inhibit_time (1800 h: 03 h)= 14 h
 Period time 10ms(10×1ms) ⇒ event_time (1800 h: 05 h)= 0A h

5. PDO mapping completed.

PDO Parameters

Drive contains 4 transmit PDOs and 4 receive PDOs. The detailed communication parameter and mapping parameter of the first transmit/receive PDO is as below and those of the rest 3 transmit/receive PDO are the same as the first PDO.

Index	1800 _h
Name	transmit_pdo_parameter_tpdo1
Object Code	RECORD
No. of Elements	4

Sub-Index	01 _h
Description	cob_id_used_by_pdo_tpdo1
Data Type	UINT32
Access	RW
PDO Mapping	NO
Units	---
Value Range	181 _h ...1FF _h , Bit 31 may be set
Default Value	181 _h

Sub-Index	02 _h
Description	transmission_type_tpdo1
Data Type	UINT8
Access	RW
PDO Mapping	NO
Units	---
Value Range	1...240,254,255
Default Value	255

Sub-Index	03 _h
Description	inhibit_time_tpdo1
Data Type	UINT16
Access	RW
PDO Mapping	NO
Units	100μs
Value Range	---
Default Value	100

Sub-Index	05 _h
-----------	-----------------

Description	event_time_tpdo1
Data Type	UINT16
Access	RW
PDO Mapping	NO
Units	1ms
Value Range	---
Default Value	10

Index	1A00 _h
Name	transmit_pdo_mapping_tpdo1
Object Code	RECORD
No. of Elements	2

Sub-Index	00 _h
Description	number_of_mapped_objects_tpdo1
Data Type	UINT8
Access	RW
PDO Mapping	NO
Units	---
Value Range	0...4
Default Value	2

Sub-Index	01 _h
Description	first_mapped_object_tpdo1
Data Type	UINT32
Access	RW
PDO Mapping	NO
Units	---
Value Range	---
Default Value	见表

Sub-Index	02 _h
Description	second_mapped_object_tpdo1
Data Type	UINT32
Access	RW
PDO Mapping	NO
Units	---
Value Range	---
Default Value	见表

Sub-Index	03 _h
Description	third_mapped_object_tpdo1
Data Type	UINT32
Access	RW
PDO Mapping	NO
Units	---
Value Range	---
Default Value	见表

Sub-Index	04 _h
Description	fourth_mapped_object_tpdo1
Data Type	UINT32
Access	RW
PDO Mapping	NO
Units	---
Value Range	---
Default Value	见表

T-PDO1

Index	Comment	Type	Acc.	Default Value
1800 _h _00 _h	number of entries	UINT8	RO	04 _h
1800 _h _01 _h	COB-ID used by PDO	UINT32	RW	00000181 _h
1800 _h _02 _h	transmission type	UINT8	RW	FF _h
1800 _h _03 _h	inhibit time (100 μs)	UINT16	RW	64 _h
1800 _h _05 _h	event time (1ms)	UINT16	RW	0A _h
1A00 _h _00 _h	number of mapped objects	UINT8	RW	02 _h
1A00 _h _01 _h	first mapped object	UINT32	RW	60410010 _h
1A00 _h _02 _h	second mapped object	UINT32	RW	60640020 _h
1A00 _h _03 _h	third mapped object	UINT32	RW	00 _h
1A00 _h _04 _h	fourth mapped object	UINT32	RW	00 _h

T-PDO2

Index	Comment	Type	Acc.	Default Value
1801 _h _00 _h	number of entries	UINT8	RO	04 _h
1801 _h _01 _h	COB-ID used by PDO	UINT32	RW	00000281 _h
1801 _h _02 _h	transmission type	UINT8	RW	FF _h
1801 _h _03 _h	inhibit time (100 μs)	UINT16	RW	64 _h
1801 _h _05 _h	event time (1ms)	UINT16	RW	0A _h
1A01 _h _00 _h	number of mapped objects	UINT8	RW	02 _h
1A01 _h _01 _h	first mapped object	UINT32	RW	60640020 _h
1A01 _h _02 _h	second mapped object	UINT32	RW	60610010 _h
1A01 _h _03 _h	third mapped object	UINT32	RW	00 _h
1A01 _h _04 _h	fourth mapped object	UINT32	RW	00 _h

T-PDO3

Index	Comment	Type	Acc.	Default Value
1802 _h _00 _h	number of entries	UINT8	RO	04 _h
1802 _h _01 _h	COB-ID used by PDO	UINT32	RW	00000381 _h
1802 _h _02 _h	transmission type	UINT8	RW	FF _h
1802 _h _03 _h	inhibit time (100 μs)	UINT16	RW	64 _h
1802 _h _05 _h	event time (1ms)	UINT16	RW	0A _h
1A02 _h _00 _h	number of mapped objects	UINT8	RW	00 _h
1A02 _h _01 _h	first mapped object	UINT32	RW	0 _h
1A02 _h _02 _h	second mapped object	UINT32	RW	0 _h
1A02 _h _03 _h	third mapped object	UINT32	RW	00 _h

Index	Comment	Type	Acc.	Default Value
1A02 _h _04 _h	fourth mapped object	UINT32	RW	00 _h

T-PDO4

Index	Comment	Type	Acc.	Default Value
1803 _h _00 _h	number of entries	UINT8	RO	04 _h
1803 _h _01 _h	COB-ID used by PDO	UINT32	RW	00000481 _h
1803 _h _02 _h	transmission type	UINT8	RW	FF _h
1803 _h _03 _h	inhibit time (100 μs)	UINT16	RW	64 _h
1803 _h _05 _h	event time (1ms)	UINT16	RW	0A _h
1A03 _h _00 _h	number of mapped objects	UINT8	RW	00 _h
1A03 _h _01 _h	first mapped object	UINT32	RW	0 _h
1A03 _h _02 _h	second mapped object	UINT32	RW	0 _h
1A03 _h _03 _h	third mapped object	UINT32	RW	00 _h
1A03 _h _04 _h	fourth mapped object	UINT32	RW	00 _h

If **transmit type is 254** (if PDO content has changed, such PDO is triggered to send), use of the following object can shield parts of PDO changers. Only when the un-shield bit has changed, PDO occurs. If wants shielding any bit, the corresponding bit of object write to 0.

tpdo_1_transmit_mask

Index	Comment	Type	Acc.	Default Value
2000 _h _00 _h	number of entries	UINT8	RO	02 _h
2000 _h _01 _h	tpdo_1_transmit_mask_low	UINT32	RW	FFFFFFFF _h
2000 _h _02 _h	tpdo_1_transmit_mask_high	UINT32	RW	FFFFFFFF _h

tpdo_2_transmit_mask

Index	Comment	Type	Acc.	Default Value
2001 _h _00 _h	number of entries	UINT8	RO	02 _h
2001 _h _01 _h	tpdo_2_transmit_mask_low	UINT32	RW	FFFFFFFF _h

Index	Comment	Type	Acc.	Default Value
2001 _h _02 _h	tpdo_2_transmit_mask_high	UINT32	RW	FFFFFFFF _h

tpdo_3_transmit_mask

Index	Comment	Type	Acc.	Default Value
2002 _h _00 _h	number of entries	UINT8	RO	02 _h
2002 _h _01 _h	tpdo_1_transmit_mask_low	UINT32	RW	FFFFFFFF _h
2002 _h _02 _h	tpdo_1_transmit_mask_high	UINT32	RW	FFFFFFFF _h

tpdo_4_transmit_mask

Index	Comment	Type	Acc.	Default Value
2003 _h _00 _h	number of entries	UINT8	RO	02 _h
2003 _h _01 _h	tpdo_2_transmit_mask_low	UINT32	RW	FFFFFFFF _h
2003 _h _02 _h	tpdo_2_transmit_mask_high	UINT32	RW	FFFFFFFF _h

R-PDO1

Index	Comment	Type	Acc.	Default Value
1400 _h _00 _h	number of entries	UINT8	RO	02 _h
1400 _h _01 _h	COB-ID used by PDO	UINT32	RW	00000201 _h
1400 _h _02 _h	transmission type	UINT8	RW	FF _h
1600 _h _00 _h	number of mapped objects	UINT8	RW	02 _h
1600 _h _01 _h	first mapped object	UINT32	RW	60400010 _h
1600 _h _02 _h	second mapped object	UINT32	RW	60FF0020 _h
1600 _h _03 _h	third mapped object	UINT32	RW	00 _h
1600 _h _04 _h	fourth mapped object	UINT32	RW	00 _h

R-PDO2

Index	Comment	Type	Acc.	Default Value
1401 _h _00 _h	number of entries	UINT8	RO	02 _h
1401 _h _01 _h	COB-ID used by PDO	UINT32	RW	00000301 _h
1401 _h _02 _h	transmission type	UINT8	RW	FF _h
1601 _h _00 _h	number of mapped objects	UINT8	RW	02 _h
1601 _h _01 _h	first mapped object	UINT32	RW	60FF0020 _h
1601 _h _02 _h	second mapped object	UINT32	RW	60600010 _h
1601 _h _03 _h	third mapped object	UINT32	RW	00 _h
1601 _h _04 _h	fourth mapped object	UINT32	RW	00 _h

R-PDO3

Index	Comment	Type	Acc.	Default Value
1402 _h _00 _h	number of entries	UINT8	RO	02 _h
1402 _h _01 _h	COB-ID used by PDO	UINT32	RW	00000401 _h
1402 _h _02 _h	transmission type	UINT8	RW	FF _h
1602 _h _00 _h	number of mapped objects	UINT8	RW	00 _h
1602 _h _01 _h	first mapped object	UINT32	RW	0 _h
1602 _h _02 _h	second mapped object	UINT32	RW	0 _h
1602 _h _03 _h	third mapped object	UINT32	RW	00 _h
1602 _h _04 _h	fourth mapped object	UINT32	RW	00 _h

R-PDO4

Index	Comment	Type	Acc.	Default Value
1403 _h _00 _h	number of entries	UINT8	RO	02 _h
1403 _h _01 _h	COB-ID used by PDO	UINT32	RW	00000501 _h
1403 _h _02 _h	transmission type	UINT8	RW	FF _h
1603 _h _00 _h	number of mapped objects	UINT8	RW	00 _h
1603 _h _01 _h	first mapped object	UINT32	RW	0 _h
1603 _h _02 _h	second mapped object	UINT32	RW	0 _h
1603 _h _03 _h	third mapped object	UINT32	RW	00 _h
1603 _h _04 _h	fourth mapped object	UINT32	RW	00 _h

6.2.4 SYNC Message

Synchronization object is used for controlling data synchronize transmit. For example, starting synchronously several axes. The transmission of synchronous message is based on Producer-Customer model. All the nodes of synchronous PDO can receive (at the same time) the message as customer and synchronize other node.

The general mode is that the SYNC master node sends the SYNC object regularly, and the SYNC slave node executes the task synchronously upon receiving it.

CANopen suggests a COB-ID with highest priority to ensure that synchronized signal could be transmitted properly. Without transferring data, SYNC message could be as short as possible.

The COB-ID of the SYNC message is fixed at 080_h, and the COB-ID can be read from 1005_h in the object dictionary.

Index	1005 _h
Name	cob_id_sync
Object Code	VAR
Data Type	UINT32
Access	RW
PDO Mapping	NO
Units	---
Value Range	80000080 _h , 00000080 _h
Default Value	00000080 _h

6.2.5 Emergency Message

When an alarm occurs to drive, CANopen will initiate an Emergency message to inform the current drive type and error code to clients. Error code displayed on panel can be read on low byte of 603Fh object.

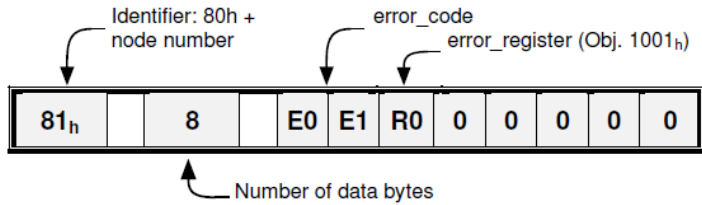
Structure of Emergency Message:

error_code (Hex)	Description
2310	Over current
3100	Instantaneous power failure
3110	Over voltage
3120	Under voltage
5080	RAM exception
5210	AD sampling error
5420	Regenerative resistor error
5421	Regenerative resistor exception
5581	Parameter checksum exception
5582	Electric gear error
5583	Motor type or drive type error
6100	Illegal error code
6120	PDO mapping error
6300	CAN communication error(Address or communication baud rate error)
7303	serial encoder error
7305	Incremental encoder error
7380	Resolver error
8100	CAN communication exception
8110	CAN bus overflow
8120	PASSIVE CAN bus turn to PASSIVE
8130	Heartbeat error
8140	CAN BUS OFF
8200	Length of CAN messages error
8210	Length of receiving PDO error
8311	Overload alarm
8480	Over speed alarm

Related Parameters

Index	1003 _h
Name	pre_defined_error_field
Object Code	ARRAY
No. of Elements	4
Data Type	UINT32
Sub-Index	01 _h
Description	standard_error_field_0
Access	RO
PDO Mapping	NO
Units	---
Value Range	---
Default Value	---
Sub-Index	02 _h
Description	standard_error_field_1
Access	RO
PDO Mapping	NO
Units	---
Value Range	---
Default Value	---
Sub-Index	03 _h
Description	standard_error_field_2
Access	RO
PDO Mapping	NO
Units	---
Value Range	---
Default Value	---
Sub-Index	04 _h
Description	standard_error_field_3
Access	RO
PDO Mapping	NO

Units	---
Value Range	---
Default Value	---

6.2.6 HEARTBEAT Message

Structure of Heartbeat Message

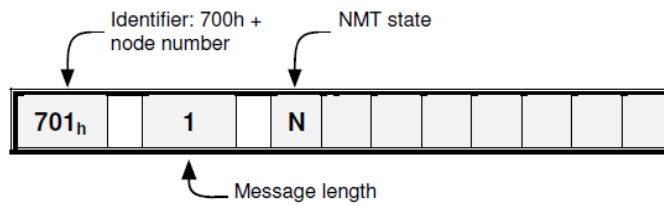

Related Parameters

Index	1017 _h
Name	producer_heartbeat_time
Object Code	VAR
Data Type	UINT16
Access	RW
PDO Mapping	NO
Units	ms
Value Range	0 - 65535
Default Value	1000

6.2.7 Network management (NMT service)

Structure of Message

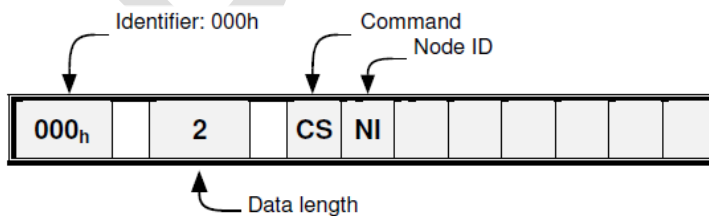

NMT state transition diagram

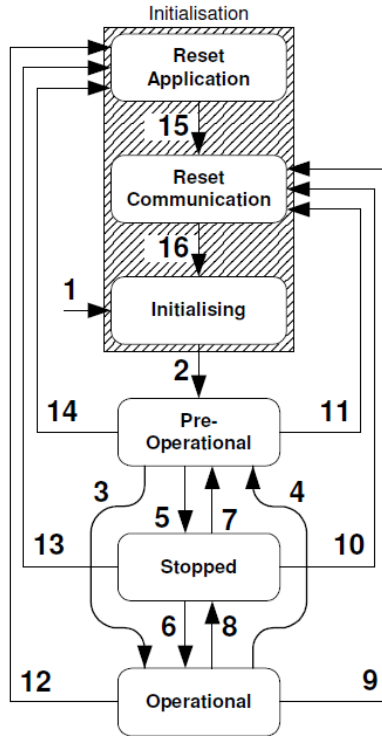

CS	Meaning	Transition	Target state
01 _h	Start Remote Node	3, 6	Operational
02 _h	Stop Remote Node	5, 8	Stopped
80 _h	Enter Pre-Operational	4, 7	Pre-Operational
81 _h	Reset Application	12, 13, 14	Reset Application
82 _h	Reset Communication	9, 10, 11	Reset Communication

Name	Meaning	SDO	PDO	NMT
Reset Application	No communication. All CAN objects are set to their reset values (application parameter set).	-	-	-
Reset Communication	No communication. The CAN controller will be re-initialised.	-	-	-
Initialising	State after Hardware Reset. Reset of the CAN node, sending of the Bootup message	-	-	-
Pre-Operational	Communication via SDOs possible. PDOs inactive (No sending / receiving)	X	-	X
Operational	Communication via SDOs possible. PDOs active (sending / receiving)	X	X	X
Stopped	No communication except heartbeat + NMT	-	-	X

6.3 Unit Conversion

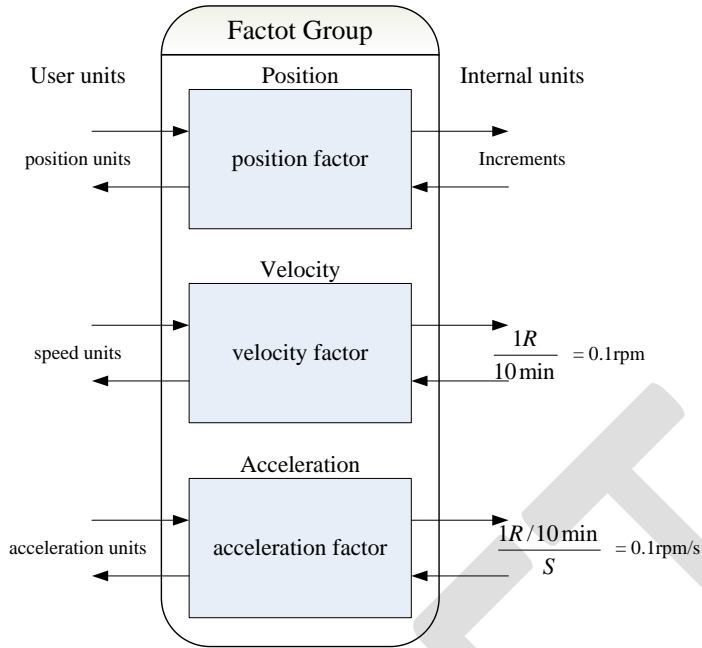

Default user unit of the drive:

Object	Name	Unit	Description
Length	position units	Increments	Pulse *
Speed	speed units	1R / 10min	0.1rpm
Acceleration	Acceleration units	1R/10min/s	0.1rpm/s
Jerk	jerk units	pulse/(s*100 μ s*100 μ s)	Value ranged from 1 to 20, the smaller the smoother

* : Ordinary incremental encoder outputs 10,000 pulses per revolution;
 Rotary encoder outputs 65,536 pulses per revolution;
 17-bit encoder outputs 131,072 pulses per revolution;
 20-bit encoder outputs 1,048,576 pulses per revolution;

6.3.1 Parameters for Unit Conversion

Index	Object	Name	Type	Attr.
6093 _h	ARRAY	position factor	UINT32	RW
6094 _h	ARRAY	velocity factor	UINT32	RW
6097 _h	ARRAY	acceleration factor	UINT32	RW

6.3.2 Position factor

Position factor module converts all the measuring units of client into internal unit of servo drive (pulse) and at the same time converts the unit (pulse) of all the output from the drive into the measuring unit of clients (position units). Position factors includes numerator and division.

Index	6093 _h
Name	position factor
Object Code	ARRAY
No. of Elements	2
Data Type	UINT32
Sub-Index	01 _h
Description	numerator
Access	RW
PDO Mapping	YES
Units	---
Value Range	---
Default Value	Initialized to the value of Pn201 when power on
Sub-Index	02 _h
Description	division
Access	RW
PDO Mapping	YES
Units	---
Value Range	---
Default Value	Initialized to the value of Pn202 when power on

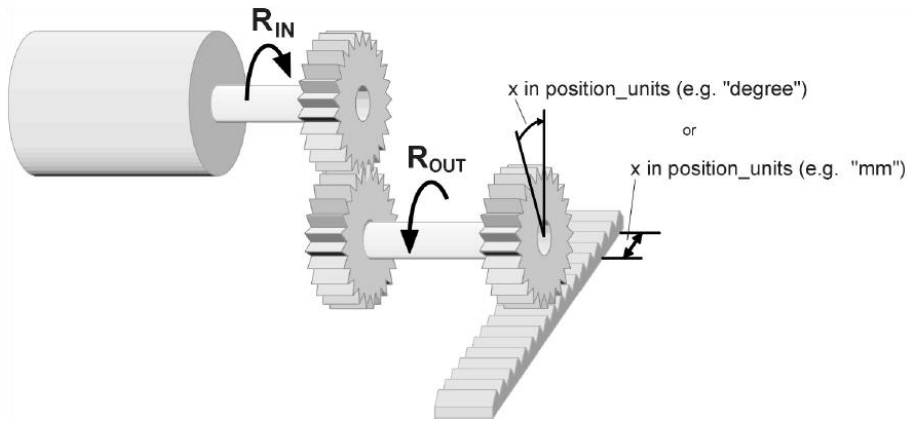

For calculating the position factors easily, 2 parameters as below are defined:

- **gear_ratio**: Reduction ratio between the load shaft and the motor shaft. (When motor's revolution is n and load's revolution is m , then **gear_ratio** = m/n)
- **feed_constant**: the distance of position units' movement when load shaft rotates for one revolution.

position factor is calculated according to:

$$\text{position factor} = \frac{\text{numerator}}{\text{division}} = \frac{\text{gear_ratio} * \text{encoder_resolution}}{\text{feed_constant}}$$

Encoder Type	encoder_resolution (Unit: Inc)
Normal incremental encoder	10000
Resolver encoder	65535
17-bit encoder	131072
20-bit encoder	1048576

6.3.3 Velocity factor

Velocity factor module converts all the speed measuring unit at customer side into drive's internal measuring unit as much as 0.1rpm. And at the same time, it converts the drive's output velocity unit (0.1rpm) into user's velocity units. Velocity factor parameters includes a numerator and a division.

Index	6094 _h
Name	velocity factor
Object Code	ARRAY
No. of Elements	2
Data Type	UINT32
Sub-Index	01 _h
Description	numerator
Access	RW
PDO Mapping	YES
Units	---
Value Range	---
Default Value	1
Sub-Index	02 _h
Description	division
Access	RW
PDO Mapping	YES
Units	---
Value Range	---
Default Value	1

For calculating velocity factor easily, 3 parameters are defined as below:

- **time_factor_v**: drive's internal time unit and user's time unit. (For example: 1min = 1/10 10min)
- **gear_ratio**: the reduction ration between the load shaft and the motor shaft. (When motor's revolution is n and load's revolution is m, then **gear_ratio** = n/m)
- **feed_constant**: the distance of position units' movement when load shaft rotates for one revolution.

velocity factor is calculated according to:

$$\text{velocity factor} = \frac{\text{numerator}}{\text{division}} = \frac{\text{gear_ratio} * \text{time_factor_v}}{\text{feed_constant}}$$

6.3.4 Acceleration factor

Acceleration factor module converts all the acceleration units at the perspective of clients into drive's internal unit (0.1rpm) and at the same time converts the output acceleration units (0.1rpm) from the drive into acceleration units at the perspective of clients. Acceleration factor parameters contain numerator and division.

Index	6097 _h
Name	acceleration factor
Object Code	ARRAY
No. of Elements	2
Data Type	UINT32
<hr/>	
Sub-Index	01 _h
Description	numerator
Access	RW
PDO Mapping	YES
Units	---
Value Range	---
Default Value	1
<hr/>	
Sub-Index	02 _h
Description	division
Access	RW
PDO Mapping	YES
Units	---
Value Range	---
Default Value	1

For calculating velocity factor easily, we could define 3 variables as below:

- **time_factor_a**: The ratio between drive's internal time square and clients' time square. (For example: $1\text{min}^2 = 1\text{min} \cdot \text{min} = 60\text{s} \cdot 1\text{min} = 60/10 \text{ 10min/s}$)
- **gear_ratio**: the reduction ration between the load shaft and the motor shaft. (When motor's revolution is n and load' s revolution is m, then $\text{gear_ratio} = n/m$)
- **feed_constant**: the distance of position units' movement when load shaft rotates for one revolution.

acceleration factor is calculated according to:

$$\text{acceleration factor} = \frac{\text{numerator}}{\text{division}} = \frac{\text{gear_ratio} * \text{time_factor_a}}{\text{feed_constant}}$$

6.4 Position Control Function

The demanding position (`position_demand_value`) output from Trajectory unit is the input of drive's position loop. Besides, the actual position (`position_actual_value`) is measured through the motor's encoder. Position control is influenced by parameter settings. To ensure the stability of the control system, we have to limit the output of position loop (`control_effect`). This output becomes the given speed for speed loop. In the Factor group, all the input and output are transformed into the internal measuring unit of the servo drive.

Following Error

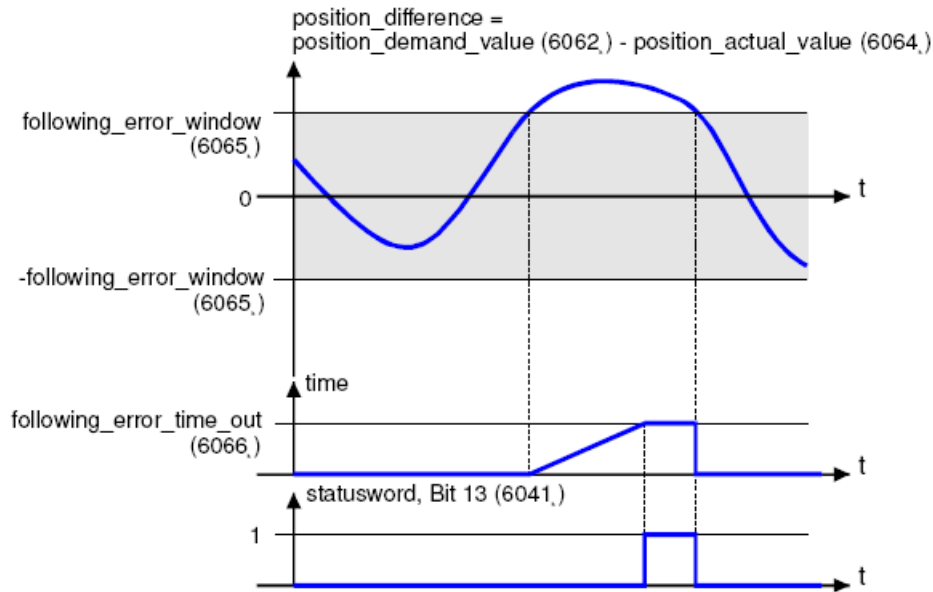

The deviation of the actual position value (`position_actual_value`) from the desired position value (`position_demand_value`) is named following error. As shown in figure above, if for a certain period of time this following error is bigger than specified in the following error window (`following_error_window`) bit 13 (`following_error`) of the object statusword will be set to 1.

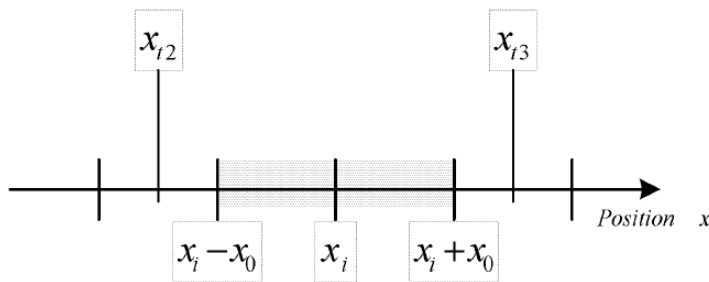
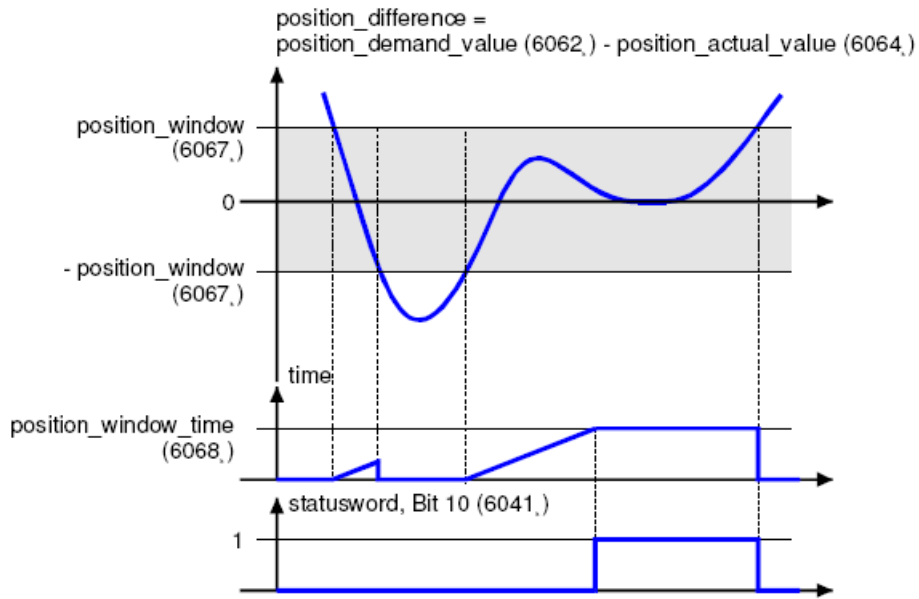

Figure above shows how the window function is defined for the message "following error". The range between $x_i - x_0$ and $x_i + x_0$ is defined symmetrically around the desired position (`position_demand_value`) x_i . For example the positions x_{i2} and x_{i3} are outside this window (`following_error_window`). If the drive leaves this window and does not return to the window within the time defined in the object `following_error_time_out` then bit 13 (`following_error`) in the statusword will be set to 1.

Position Reached

This function offers the chance to define a position window around the target position (`target_position`). If the actual position of the drive is within this range for a certain period of time - the `position_window_time` - bit 10 (`target_reached`) will be set to 1 in the statusword. As shown in figure below.



The figure below shows the position_windows are symmetrically distributed around the target_position), i.e. the range from $x_i - x_0$ to $x_i + x_0$. For example, the positions x_{t0} and x_{t1} are in the position windows. If the drive is in the window, a fixed period starts timing. If the fixed period reaches the position_window_time and the drive position is always in the window during the time, then bit10 (target_reached) in the statusword_will be set to 1. As soon as the drive position leaves the window, bit10 (target_reached) in the statusword will be cleared to zero immediately.

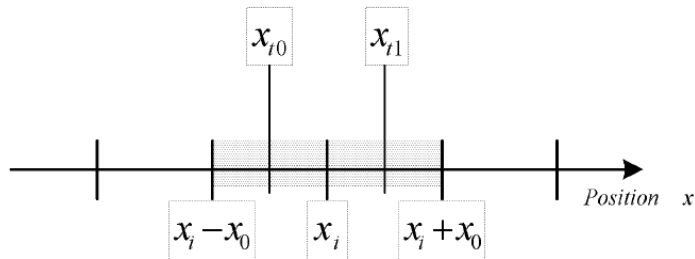

Related Parameters

Index	Object	Name	Type	Attr.
6062 _h	VAR	position_demand_value	INT32	RO
6063 _h	VAR	position_actual_value*	INT32	RO
6064 _h	VAR	position_actual_value	INT32	RO
6065 _h	VAR	following_error_window	UINT32	RW
6066 _h	VAR	following_error_time_out	UINT16	RW
6067 _h	VAR	position_window	UINT32	RW
6068 _h	VAR	position_time	UINT16	RW
60FA _h	VAR	control_effort	INT32	RO

Index	6062 _h
Name	position_demand_value
Object Code	VAR
Data Type	INT32
Access	RO
PDO Mapping	YES
Units	position units
Value Range	--
Default Value	--

Index	6064 _h
Name	position_actual_value
Object Code	VAR
Data Type	INT32
Access	RO
PDO Mapping	YES
Units	position units
Value Range	--
Default Value	--

Index	6065 _h
Name	following_error_window
Object Code	VAR
Data Type	UINT32
Access	RW
PDO Mapping	YES
Units	position units
Value Range	0 - 7FFFFFFF _h
Default Value	30000

Index	6066 _h
Name	following_error_time_out
Object Code	VAR
Data Type	UINT16
Access	RW

PDO Mapping	YES
Units	ms
Value Range	0 - 65535
Default Value	200
<hr/>	
Index	60FA _h
Name	control_effort
Object Code	VAR
Data Type	INT32
Access	RO
PDO Mapping	YES
Units	speed units
Value Range	--
Default Value	--
<hr/>	
Index	6067 _h
Name	position_window
Object Code	VAR
Data Type	UINT32
Access	RW
PDO Mapping	YES
Units	position units
Value Range	--
Default Value	10
<hr/>	
Index	6068 _h
Name	position_time
Object Code	VAR
Data Type	UINT16
Access	RW
PDO Mapping	YES
Units	ms
Value Range	0 - 65535
Default Value	50

6.5 Device Control

6.5.1 Control State Machine

The master controls the drive through the controlword, and knows the current status of the drive by reading the statusword of the drive.

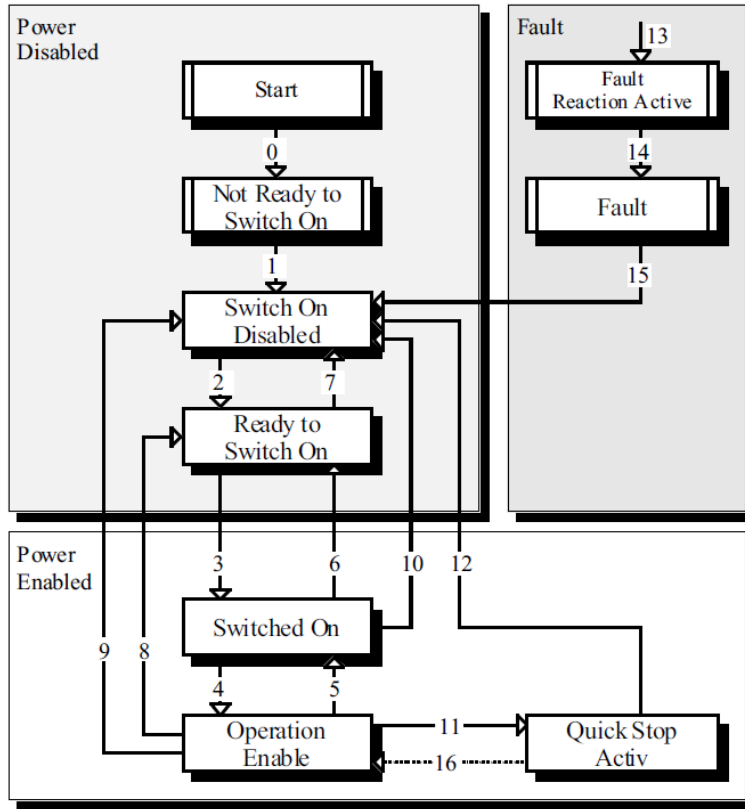

According to figure above, the state diagram can be divided into three main parts: "Power Disabled" (means the main power supply is switched off), "Power Enabled" (the main power supply is turned on) and "Fault". All states enter "Fault" after an alarm occurs. After switching on the servo controller initializes itself and enters the state SWITCH_ON_DISABLED. In this state CAN communication is possible and the servo controller can be parameterized (e.g. the working mode of drive can be set to "PP" mode). The main power supply remains switched off and the motor is not excited. Through the state transitions 2, 3 and 4, the state OPERATION_ENABLE will be reached. In this state the main power supply is turned on and the servo controller controls the motor according to the parameterized working mode. Therefore, it must be confirmed that the parameters of the drive have been correctly configured and the corresponding input value is zero before such state. The circuit main power supply will be turned off after state transition 9 is done. Once the driver alarms, the driver enters FAULT.

Status	Description
Not Ready to Switch On	The servo controller executes its self-test. The CAN communication is not working
Switch On Disabled	The self-test has been completed. The CAN communication is activated
Ready to Switch On	Servo driver is waiting for the state of Switch and servo motor is not at main power supply
Switched On	The main power supply is turned on
Operation Enable	The motor is under voltage and is controlled according to working mode
Quick Stop Active	Servo driver will be stopped through its fixed way

Status	Description
Fault Reaction Active	Servo driver tests error and will be stopped through its fixed way, with motor's main power supply turned on
Fault	An error has occurred. The main power supply has been turned off.

6.5.2 Related Parameters of Device Control

Index	Object	Name	Type	Attr.
6040 _h	VAR	controlword	UINT16	RW
6041 _h	VAR	statusword	UINT16	RO
605A _h	VAR	quick_stop_option_code	INT16	RW
605B _h	VAR	shutdown_option_code	INT16	RW
605C _h	VAR	disabled_operation_option_code	INT16	RW
605D _h	VAR	halt_option_code	INT16	RW
605E _h	VAR	fault_reaction_option_code	INT16	RW

6.5.3 Controlword

Index	6040 _h
Name	controlword
Object Code	VAR
Data Type	UINT16
Access	RW
PDO Mapping	YES
Units	--
Value Range	--
Default Value	0

15	11	10	9	8	7	6	4	3	2	1	0
manufacturer specific	reserved	halt	Fault reset	Operation mode specific	Enable operation	Quick stop	Enable voltage	Switch on			

Bit0to3 and Bit7

The transmission of the state machine is triggered by the control command composed of those 5 bits.

Command	Bit of the <i>controlword</i>					Transitions
	Fault reset	Enable operation	Quick stop	Enable voltage	Switch on	
Shutdown	0	X	1	1	0	2,6,8
Switch on	0	0	1	1	1	3*
Switch on	0	1	1	1	1	3**
Disable voltage	0	X	X	0	X	7,9,10,12
Quick stop	0	X	0	1	X	7,10,11
Disable operation	0	0	1	1	1	5
Enable operation	0	1	1	1	1	4,16
Fault reset		X	X	X	X	15

[Note] X means this bit could be ignored.

Bit4, 5, 6 and 8

The definition of this 4 bit is different in different control mode.

Bit	Control mode		
	profile position mode	profile velocity mode	homing mode
4	new_set_point	Reserve	start_homing_operation
5	change_set_immediately	Reserve	Reserve
6	abs/rel	Reserve	Reserve
8	Halt	Halt	Halt

Other bits

All reserved.

6.5.4 Statusword

Index	6041 _h
Name	statusword
Object Code	VAR
Data Type	UINT16
Access	RO
PDO Mapping	YES
Units	--
Value Range	--
Default Value	--

Explanation of statusword bit is as below:

Bit	Description
0	Ready to switch on
1	Switched on

Bit	Description
2	Operation enabled
3	Fault
4	Voltage enabled
5	Quick stop
6	Switch on disabled
7	Warning
8	Reserved
9	Remote
10	Target reached
11	Internal limit active
13to12	Operation mode specific
15to14	Reserved

Bit0~3 , Bit5 and Bit6

The combination of these bits indicates the status of drives.

Value (binary)	State
xxxx xxxx x0xx 0000	Not ready to switch on
xxxx xxxx x1xx 0000	Switch on disabled
xxxx xxxx x01x 0001	Ready to switch on
xxxx xxxx x01x 0011	Switched on
xxxx xxxx x01x 0111	Operation enabled
xxxx xxxx x00x 0111	Quick stop active
xxxx xxxx x0xx 1111	Fault reaction active
xxxx xxxx x0xx 1000	Fault

Bit4: Voltage enabled

Main power supply is turned on when this bit is 1.

Bit5: Quick stop

Driver will halt by following settings (605A h: quick_stop_option_code) when this bit is 0.

Bit7: Warning

Driver detects alarm when this bit is 1.

Bit9: Warning

Servo can deal with Controlword when the enabling state of this bit is at 1.

Bit10: Target reached

In different control modes the meaning of this bit is different.

- In profile position mode, when set position is reached, this bit is set. When Halt is booted, speed is reduced to 0 and this bit will be set. When new position is set, this bit will be cleared.
- In profile Velocity Mode, when the speed reaches the targeted speed, this bit will be set. When Halt is booted and speed is reduced to 0, this bit is set.

Bit11: Internal limit active

When this bit is 1, it indicates that internal torque has surpassed the set value, or reached the max forward/reverse limit position. It can be confirmed by reading object 60FDh (digital inputs).

Bit12-13

These 2 bits have different meanings in different control mode.

Bit	Control Mode		
	profile position mode	profile velocity mode	homing mode
12	Set-point acknowledge	Speed	Homing attained
13	Following error	Max slippage error	Homing error

Other bits

All reserved.

6.5.5 Shutdown_option_code

The object shutdown_option_code determines the behavior when the state transition from OPERATION ENABLE to READY TO SWITCH ON is executed.

Index	605B _h
Name	shutdown_option_code
Object Code	VAR
Data Type	INT16
Access	RW
PDO Mapping	NO
Units	--
Value Range	0,1
Default Value	0

Value	Description
0	Drive enters OFF state and stops according to Pn003.0 setting
1	After deceleration stops at 6084h, the drive cuts off the power supply to the motor

6.5.6 Disable_operation_option_code

The object `disable_operation_option_code` determines the behavior if the state transition from OPERATION ENABLE to SWITCHED ON is executed.

Index	605C _h
Name	disable_operation_option_code
Object Code	VAR
Data Type	INT16
Access	RW
PDO Mapping	NO
Units	--
Value Range	0,1
Default Value	0

Value	Description
0	Drive enters OFF state and stops according to Pn003.0 setting
1	After decelerates and stops at 6084h, the drive will cut off the power supply to the motor

6.5.7 Quick_stop_option_code

The object `quick_stop_option_code` determines the behavior if the state transition from Operation Enable to Quick Reaction Active is executed.

Index	605A _h
Name	quick_stop_option_code
Object Code	VAR
Data Type	INT16
Access	RW
PDO Mapping	NO
Units	--
Value Range	0,1,2,5,6
Default Value	2

Value	Description
0	Drive enters OFF state and stops according to Pn003.0 setting

Value	Description
1	After decelerates and stops at 6084h, the drive will cut off the power supply to the motor
2	After decelerates and stops at 6085h, the drive will cut off the power supply to the motor
3,4	—
5	After decelerates and stops at 6084h, the drive will stay in QuickStop.
6	After decelerates and stops at 6085h, the drive will stay in QuickStop.

6.5.8 Halt_option_code

halt_option_code determines how to stop when bit.8 (halt) of controlword is set to 1.

Index	605D _h
Name	halt_option_code
Object Code	VAR
Data Type	INT16
Access	RW
PDO Mapping	NO
Units	--
Value Range	1,2
Default Value	0

Value	Description
1	Motor decelerates and stops.
2	Motor decelerates and stops urgently.

6.5.9 Fault_reaction_option_code

When an error is occurred, fault_reation_option_code determines how to stop.

Index	605E _h
Name	fault_reaction_option_code
Object Code	VAR
Data Type	INT16
Access	RW
PDO Mapping	NO

Units	--
Value Range	0
Default Value	0

Value	Description
0	Shut down the motor excitation signal. Motor is freely rotatable.

6.6 Control Mode

ProNet/EDS/ETS currently supports 5 control modes in CANopen DSP402:

- HOMING MODE
- PROFILE VELOCITY MODE
- PROFILE TORQUE MODE
- PROFILE POSITION MODE
- INTERPOLATED POSITION MODE

Relevant parameter of control mode

Index	Object	Name	Type	Attr.
6060 _h	VAR	modes_of_operation	INT8	RW
6061 _h	VAR	modes_of_operation_display	INT8	RO

Modes_of_operation

Drive control mode will be determined by parameters of modes_of_operation.

Index	6060 _h
Name	modes_of_operation
Object Code	VAR
Data Type	INT8
Access	RW
PDO Mapping	YES
Units	--
Value Range	1,3,4,6,7
Default Value	1

Value	Description
1	PROFILE POSITION MODE
3	PROFILE VELOCITY MODE
4	PROFILE TORQUE MODE
6	HOMING MODE
7	INTERPOLATION MODE

Modes_of_operation_display

Drive current control mode could be read from parameters in modes_of_operation_display.

Index	6061 _h
Name	modes_of_operation_display
Object Code	VAR
Data Type	INT8
Access	RO
PDO Mapping	YES
Units	--
Value Range	1,3,4,6,7
Default Value	1

[Note] The current control mode could be only known from parameters in modes_of_operation_display.

6.7 HOMING MODE

Servo drive currently supports multiple homing mode, and users could choose the suitable homing mode.

The user can determine the way of homing, and its velocity and acceleration. After the servo controller has found its reference, the current position is displayed as the value set by home_offset (607C_h).

6.7.1 Control word of homing mode

15 ~ 9	8	7 ~ 5	4	3 ~ 0
*	Halt	*	home_operation_start	*

*: Refer to previous chapters

Name	Value	Description
Homing operation start	0	Homing mode inactive
	0 → 1	Start homing mode
	1	Homing mode active
	1 → 0	Interrupt homing mode
Halt	0	Execute the instruction of bit 4
	1	Stop axle with homing acceleration

6.7.2 Status word of homing mode

15 ~ 14	13	12	11	10	9 ~ 0
*	homing_error	homing_attained	*	target_reached	*

*: Refer to previous chapters

Name	Value	Description
Target reached	0	Halt = 0: Home position not reached Halt = 1: Axle decelerates
	1	Halt = 0: Home position reached Halt = 1: Axle has velocity 0
Homing attained	0	Homing mode not yet completed
	1	Homing mode carried out successfully
Homing error	0	No homing error
	1	Homing error occurred; Homing mode carried out not successfully; The error cause is found by reading the error code

6.7.3 Related Parameters of homing mode

Index	Object	Name	Type	Attr.
607C _h	VAR	home_offset	INT32	RW
6098 _h	VAR	homing_method	INT8	RW
6099 _h	ARRAY	homing_speeds	UINT32	RW
609A _h	VAR	homing_acceleration	INT32	RW

home_offset

The parameter `home_offset` determines the distance between the reference position and the zero position.

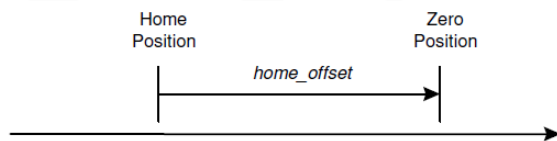

Index	607C _h
Name	home_offset
Object Code	VAR
Data Type	INT32
Access	RW
PDO Mapping	YES
Units	position units
Value Range	--

Default Value 0

homing_method

4 kinds of signals can be used as the homing signal: positive limit switch, negative limit switch, reference switch and C pulse.

Index	6098 _h
Name	homing_method
Object Code	VAR
Data Type	INT8
Access	RW
PDO Mapping	YES
Units	--
Value Range	1-14, 17-22, 23-30, 33-35
Default Value	1

List of Homing Modes

Mode	Direction	Target	Reference Position	DS402
1	Negative	NOT	C pulse	1
2	Positive	POT	C pulse	2
3	Negative	Reference switch	C pulse	3
4	Positive	Reference switch	C pulse	4
5	Negative	Reference switch	C pulse	5
6	Positive	Reference switch	C pulse	6
7	Positive	Reference switch	C pulse	7
8	Positive	Reference switch	C pulse	8
9	Positive	Reference switch	C pulse	9
10	Positive	Reference switch	C pulse	10
11	Negative	Reference switch	C pulse	11
12	Negative	Reference switch	C pulse	12
13	Negative	Reference switch	C pulse	13
14	Negative	Reference switch	C pulse	14
17	Negative	NOT	NOT	17
18	Positive	POT	POT	18
19	Negative	Reference switch	Reference switch	19

Mode	Direction	Target	Reference Position	DS402
20	Positive	Reference switch	Reference switch	20
21	Negative	Reference switch	Reference switch	21
22	Positive	Reference switch	Reference switch	22
23	Positive	Reference switch	Reference switch	23
24	Positive	Reference switch	Reference switch	24
25	Positive	Reference switch	Reference switch	25
26	Positive	Reference switch	Reference switch	26
27	Negative	Reference switch	Reference switch	27
28	Negative	Reference switch	Reference switch	28
29	Negative	Reference switch	Reference switch	29
30	Negative	Reference switch	Reference switch	30
33	Negative	Current position	C pulse	33
34	Positive	Current position	C pulse	34
35	--	Current position	Current position	35
-4	Positive	Target torque	C pulse	Defined by manufacturer
-3	Negative	Target torque	C pulse	Defined by manufacturer
-2	Positive	Target torque	Target torque	Defined by manufacturer
-1	Negative	Target torque	Target torque	Defined by manufacturer

homing_speeds

Two kinds of speed are required to find reference point, speed during search for switch and speed during search for zero.

Index	6099 _h
Name	homing_speeds
Object Code	ARRAY
No. of Elements	2
Data Type	INT32

Sub-Index	01 _h
Name	speed_during_search_for_switch
Object Code	VAR

Data Type	INT32
Access	RW
PDO Mapping	YES
Units	speed units
Value Range	--
Default Value	5000

Sub-Index	02 _h
Name	speed_during_search_for_zero
Object Code	VAR
Data Type	INT32
Access	RW
PDO Mapping	YES
Units	speed units
Value Range	--
Default Value	100

Pn207 (stopper torque)

The locked-rotor torque value used by the homing modes -4, -3, -2 and -1. When the machine hits the stop and reaches the torque value set by Pn207 and keeps the filter time set by Pn208, find the C pulse in the reverse direction or make the current position for the origin.

Index	3049 _h
Name	Pn207 (stopper torque)
Object Code	VAR
Data Type	UINT16
Access	RW
PDO Mapping	NO
Units	1% rated torque
Value Range	0-200
Default Value	20

Pn208 (blocking time)

The locked-rotor torque value used by the homing modes -4, -3, -2 and -1. When the machine hits the stop and reaches the torque value set by Pn207 and keeps the filter time set by Pn208, find the C pulse in the reverse direction or make the current position for the origin.

Index	304A _h
-------	-------------------

Name	Pn208 (Blocking time)
Object Code	VAR
Data Type	UINT16
Access	RW
PDO Mapping	NO
Units	0.125ms
Value Range	0-10000
Default Value	100

homing_acceleration

The objects homing_acceleration determine the acceleration and deceleration during homing.

Index	609A _h
Name	homing_acceleration
Object Code	VAR
Data Type	INT32
Access	RW
PDO Mapping	YES
Units	acceleration units
Value Range	--
Default Value	100000

6.7.4 Homing Methods

Method 1: Using C pulse and negative limit switch

A: When homing mode is enabled, if negative limit switch N-OT=0, the drive first moves quickly to the negative direction and stops until it reaches the rising edge of negative limit switch (N-OT). Afterwards the drive slowly returns, and stops until reaches the 1st C pulse of falling edge of negative limit switch (N-OT).

B: When homing mode is enabled, if negative limit switch N-OT=1, the drive first moves slowly to the positive direction, and stops until reaches the 1st C pulse of falling edge of negative limit switch (N-OT).

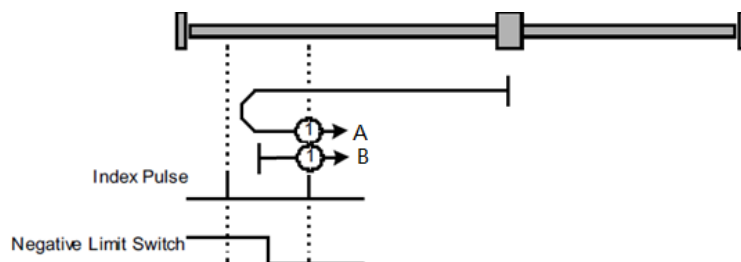

Method 2: Using C pulse and positive limit switch

A: When homing mode is enabled, if positive limit switch P-OT=0, the drive first moves quickly to the positive direction, and stops until it reaches the rising edge of positive limit switch (P-OT). Afterwards the drive slowly returns, and stops until reaches the 1st C pulse of falling edge of positive limit switch (P-OT).

B: When homing mode is enabled, if positive limit switch P-OT=1, the drive first moves slowly to the negative direction, and stops until reaches the 1st C pulse of falling edge of positive limit switch (P-OT).

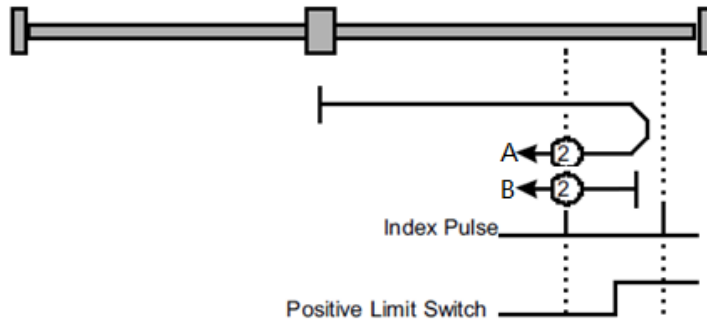
Methods 3 and 4: Using C pulse and positive reference switch

- Method 3

A: When homing mode is enabled, if positive reference switch H-S=0, the drive first moves quickly to the positive direction, and stops until it reaches the 1st C pulse of rising edge of positive reference switch (H-S). Afterwards the drive slowly returns, and stops until reaches the 1st C pulse of falling edge of positive reference switch (H-S).

B: When homing mode is enabled, if positive reference switch H-S =1, the drive first moves slowly to the negative direction, and stops until reaches the 1st C pulse of falling edge of positive reference switch (H-S).

- Method 4

A: When homing mode is enabled, if positive reference switch H-S =0, the drive first moves slowly to the positive direction, and stops until reaches the 1st C pulse of falling edge of positive reference switch (H-S).

B: When homing mode is enabled, if positive reference switch H-S=1, the drive first moves quickly to the negative direction, and stops until it reaches the 1st C pulse of falling edge of positive reference switch (H-S). Afterwards the drive slowly returns, and stops until reaches the 1st C pulse of rising edge of positive reference switch (H-S).

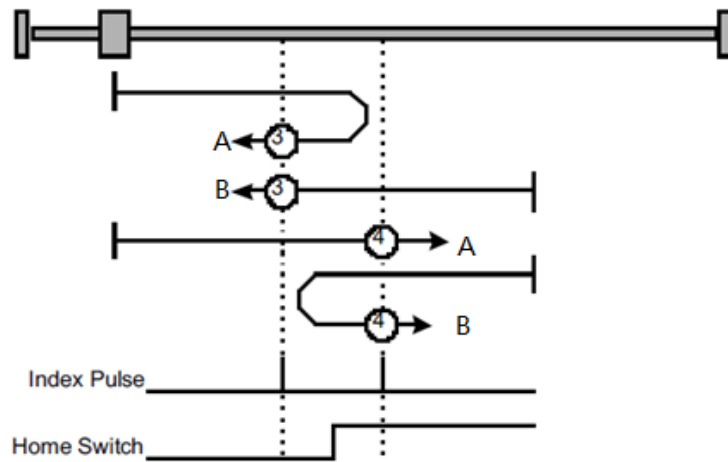

Methods 5 and 6: Using C pulse and negative reference switch

- Method 5

A: When homing mode is enabled, if negative reference switch H-S=1, the drive first moves slowly to the positive direction, and stops until it reaches the 1st C pulse of falling edge of negative reference switch (H-S).

B: When homing mode is enabled, if positive reference switch H-S=0, the drive first moves quickly to the negative direction, and stops until reaches the 1st C pulse of rising edge of negative reference switch (H-S). Afterwards the drive slowly returns, and stops until reaches the 1st C pulse of falling edge of negative reference switch (H-S).

- Method 6

A: When homing mode is enabled, if negative reference switch H-S=1, the drive first moves quickly to the positive direction, and stops until reaches the 1st C pulse of falling edge of negative reference switch (H-S). Afterwards the drive slowly returns, and stops until reaches the 1st C pulse of falling edge of negative reference switch (H-S).

B: When homing mode is enabled, if negative reference switch H-S=0, the drive first moves slowly to the negative direction, and stops until it reaches the 1st C pulse of rising edge of negative reference switch (H-S).

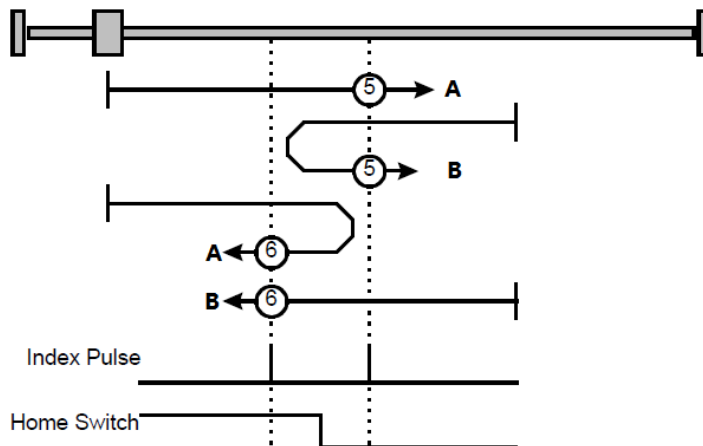

Methods 7-14: Using reference switch , limit switch and C pulse

Methods 7-14 use the reference switch which is only active over parts of the travel.

- When the positive limit switch (POT) is used for homing, the initial direction of methods 7-10 is the positive direction

– Method 7

A: When homing mode is enabled, if reference switch H-S=0, the drive first moves quickly into the positive direction, but not reaches positive limit switch, and stops until it reaches the rising edge of reference switch (H-S). Afterwards the drive slowly returns, and stops until reaches 1st C pulse of the falling edge of reference switch (H-S).

B: When homing mode is enabled, if reference switch H-S =1, the drive first moves slowly into the negative direction, and stops until reaches 1st C pulse of the falling edge of reference switch (H-S).

C: When homing mode is enabled, if reference switch H-S=0, the drive first moves quickly into the positive direction, reaches positive limit switch, and moves quickly to the negative direction. When it reaches the rising edge of the reference switch (H-S), it starts to decelerate and continues to run in the negative direction, and stops when it reaches the 1st C pulse after the falling edge of the reference switch (H-S).

– Method 8

A: When homing mode is enabled, if reference switch H-S=0, the drive first moves quickly into the positive direction, but not reaches positive limit switch, and slows down until it reaches the rising edge of reference switch (H-S). Afterwards it moves to positive direction, and stops until finds the 1st C pulse.

B: When homing mode is enabled, if reference switch H-S =1, the drive first moves slowly to the negative direction, and turn around until reaches the falling edge of reference switch (H-S). Then moves slowly into the positive direction, and stops when it reaches the 1st C pulse after the rising edge of the reference switch (H-S).

C: When homing mode is enabled, if reference switch H-S=0, the drive first moves quickly to the positive direction, and reaches positive limit switch; then it moves quickly into the negative direction, and slows down after reaching the rising edge of reference switch (H-S). Afterwards it moves to negative direction, and returns to positive direction slowly. It stops until reaches the 1st C pulse of the rising edge of reference switch (H-S).

– Method 9

A: When homing mode is enabled, if reference switch H-S=0, the drive first moves in the positive direction quickly, but not reaches the positive limit switch, and it slowly down after reaching the rising edge of the reference switch (HS), and continues to run slowly in the positive direction. Afterwards it slows down and stops after reaching the falling edge of the reference switch (HS). Then the drive returns slowly, and stops when it reaches the 1st C pulse behind the rising edge of the reference switch (HS).

B: When homing mode is enabled, if reference switch H-S =1, the drive runs slowly in the positive direction directly, reverses after reaching the falling edge of the reference switch (H-S). Afterwards it moves slowly in the negative direction, and stops after it reaches the 1st C pulse of the rising edge of the reference switch (H-S).

C: When homing mode is enabled, if reference switch H-S=0, the drive moves in the positive direction first, and when it reaches the positive limit switch, the drive automatically runs in the reverse direction at a high speed. After reaching the rising edge of the reference switch (HS), it slows down and continues to move slowly in the negative direction, and stops until the 1st C pulse is found.

– Method 10

A: When homing mode is enabled, if reference switch H-S=0, the drive first moves in the positive direction quickly, but reaches the positive limit switch, and it slows down when reaching the rising edge of the reference switch (HS), and continues to run slowly in the positive direction. Afterwards it continues to run in the positive direction after reaching the falling edge of the reference switch (HS), and stops until the 1st C pulse is found.

B: When homing mode is enabled, if reference switch H-S =1, the drive runs slowly in the positive direction, and stops at the 1st C pulse behind the falling edge of the reference switch (H-S).

C: When homing mode is enabled, if reference switch H-S=0, the drive moves in the positive direction first, and when it reaches the positive limit switch, the drive

automatically runs in the reverse direction at a high speed. After reaching the rising edge of the reference switch (HS), it slows down and stops, and then returns slowly, and continues to move slowly in the positive direction. It stops after reaching the 1st C pulse of the falling edge of the reference switch (H-S).

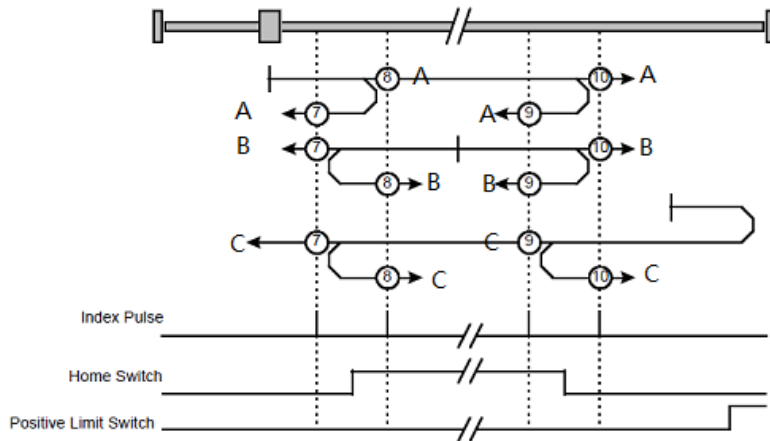

- When the negative limit switch (NOT) is used for homing, the method 11-14 is almost same as method 7-10, and the drive first moves to the negative direction.

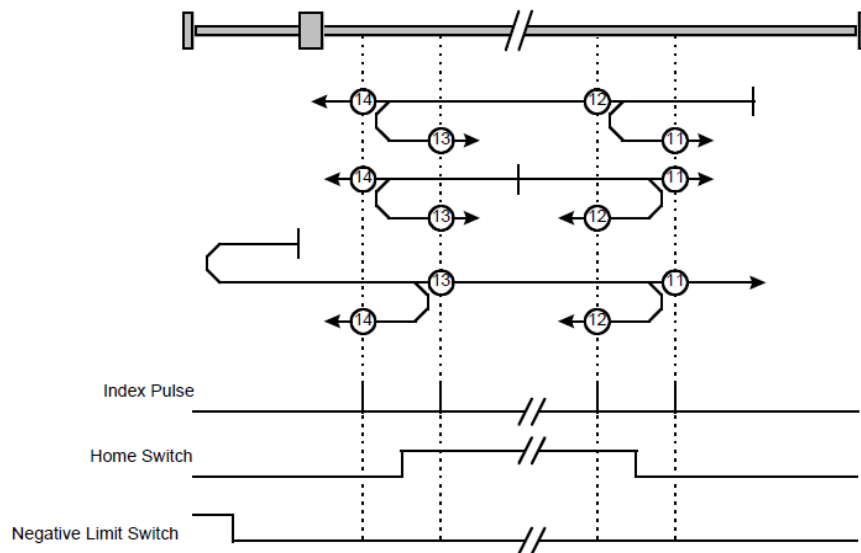

Methods 17-20, 23-30: Not using C pulse

Homing methods 17-30 are similar to methods 1-4, and 7-14, but the target homing position is not relied on C pulse any more but on the change of limit switch or reference point. For example, as below, method 19 and method 20 are just similar to method 3 and method 4.

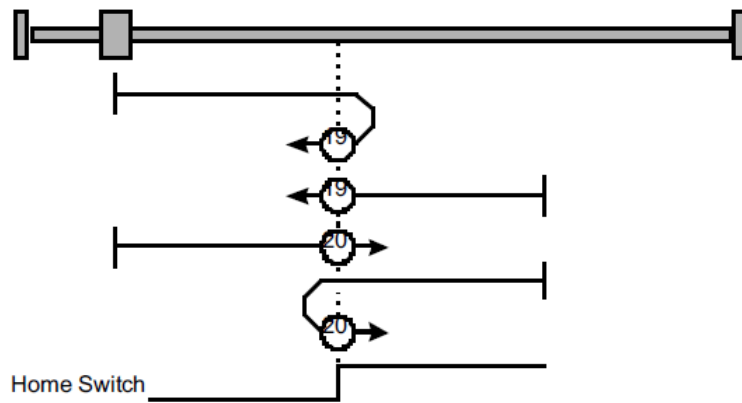

Methods 21, 22 Homing by using reference switch

These two homing methods are similar to 5 and 6, except that the C pulse is not used for target zero position, but depends on the change of the reference switch.

- Method 21

A: When homing mode is enabled, if reference switch H-S =1, the drive runs slowly in the positive direction, and stops when it reaches the falling edge of the reference switch (H-S).

B: When homing mode is enabled, if reference switch H-S=0, the drive first moves in the negative direction quickly, slows down and stops when it reaches the rising edge of the reference switch (HS), then the drive returns slowly and runs in the positive direction. It stops when reaching the falling edge of the reference switch (HS).

- Method 22

A: When homing mode is enabled, if reference switch H-S =1, the drive first moves in the positive direction quickly, slows down and stops when it reaches the falling edge of the reference switch (HS). Afterwards it returns slowly, runs in the negative direction, and stops when reaching the rising edge of the reference switch (HS).

B: When homing mode is enabled, if reference switch H-S=0, the drive runs slowly in the negative direction, and stops when reaching the rising edge of the reference switch (H-S).

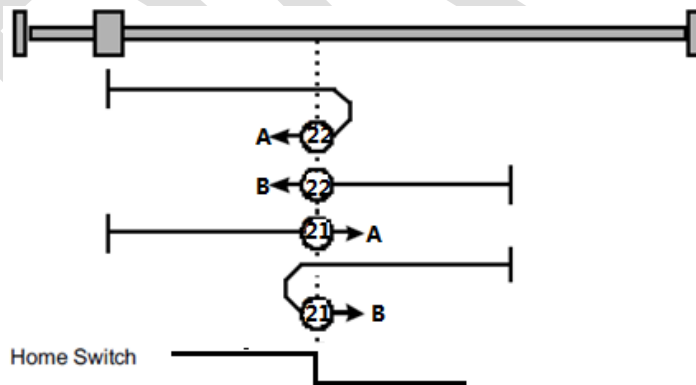

Methods 33 and 34: Homing by using C pulse

- Method 33: The drive moves slowly into the negative direction, and stops when reaching the 1st C pulse.
- Method 34: The drive moves slowly into the positive direction, and stops when reaching the 1st C pulse.

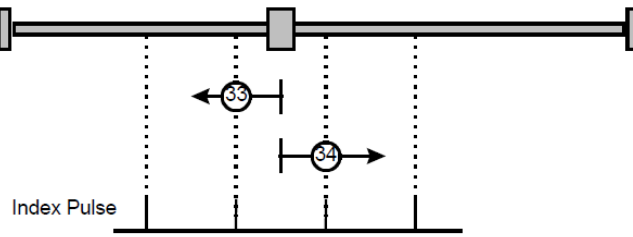

Method 35: Homing on the current position

In this method, the current position shall be taken to be the home position.

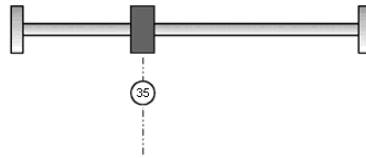

Method-4: Movement in positive direction, hitting an end and reversing to travel, the target homing position is the C pulse

In this method, the motor moves in positive direction. When it hits an end so that the torque set in Pn207 is reached for the blocking time set in Pn208, movement in the opposite direction, and the target homing position is the first C pulse.

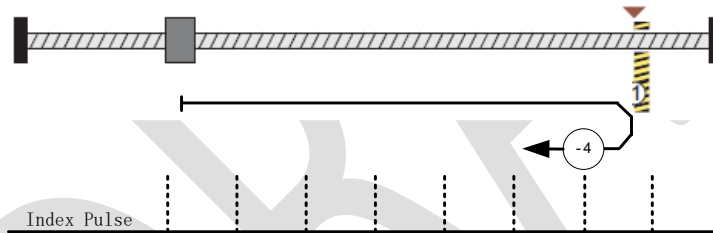

Movement in negative direction, hitting an end and reversing to travel, the target homing position is the C pulse

In this method, the motor moves in negative direction. When it hits an end so that the locked-rotor torque set in Pn207 is reached for the blocking time set in Pn208, movement in the opposite direction, and the target homing position is the first C pulse.

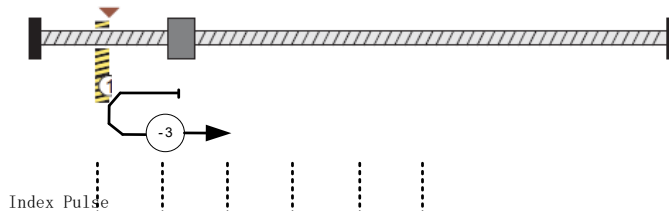

Method -2: Movement in positive direction, hitting an end, makes the current position for the homing point

In this method, the motor moves in positive direction. When the drive hits an end so that the locked-rotor torque set in Pn207 is reached for the blocking time set in Pn208, and makes the current position for the origin.

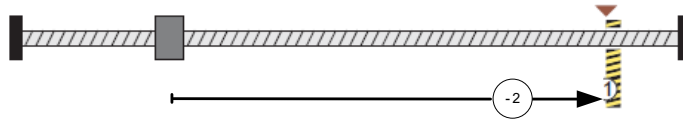

Method -1: Movement in negative direction, hitting an end, makes the current position for the homing point

In this method, the motor moves in negative direction. When the drive hits an end so that the locked-rotor torque set in Pn207 is reached for the blocking time set in Pn208, and makes the current position for the origin.

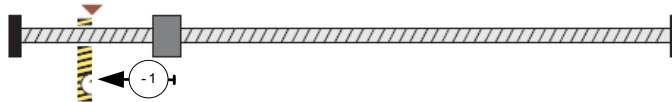

Notes: When starting homing on homing method about input signal, the rotation direction of servo motor is associated with the initial status of the limit switch. Changing the initial status by inverse input, if it is necessary.

6.8 PROFILE VELOCITY MODE

6.8.1 Flow Chart of Profile Velocity Mode

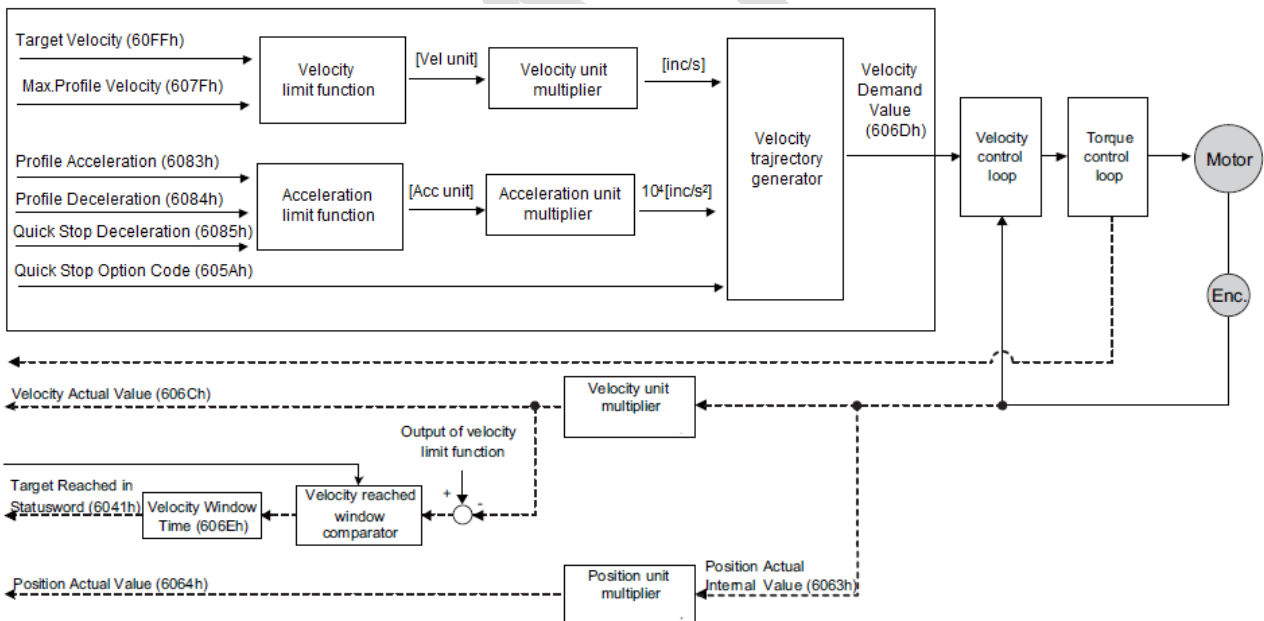

6.8.2 Control Word

15 ~ 9	8	7 ~ 4	3 ~ 0
*	Halt	*	*

*: Refer to previous chapters

Name	Value	Description
Halt	0	Execute the motion
	1	Stop axle

6.8.3 Status Word

15 - 14	13	12	11	10	9 - 0
*	MaxSlippageError	Speed	*	Target reached	*

*: Refer to previous chapters

Name	Value	Description
Target reached	0	Halt = 0: <i>Target velocity</i> not (yet) reached Halt = 1: Axle decelerates
	1	Halt = 0: <i>Target velocity</i> reached Halt = 1: Axle has velocity 0
Speed	0	Speed is not equal 0
	1	Speed is equal 0
Max slippage error	0	Maximum slippage not reached
	1	Maximum slippage reached

6.8.4 Related Parameters

Index	Object	Name	Type	Attr.
6069 _h	VAR	velocity_sensor_actual_value	INT32	RO
606B _h	VAR	velocity_demand_value	INT32	RO
606C _h	VAR	velocity_actual_value	INT32	RO
606D _h	VAR	velocity_window	UINT16	RW
606E _h	VAR	velocity_window_time	UINT16	RW
606F _h	VAR	velocity_threshold	UINT16	RW
6070 _h	VAR	velocity_threshold_time	UINT16	RW
607F _h	VAR	Max profile velocity	UINT32	RW
60FF _h	VAR	target_velocity	INT32	RW

velocity_sensor_actual_value

The master could read `velocity_sensor_actual_value` to know the current velocity. The parameter's unit is internal speed unit.

Index	6069 _h
Name	velocity_sensor_actual_value
Object Code	VAR
Data Type	INT32
Access	RW
PDO Mapping	YES
Units	0.1rm/s (1R/10min)
Value Range	--

Default Value	--
---------------	----

velocity_demand_value

The master can read velocity_demand_value to know the current reference speed value of the servo drive. The unit of this parameter is user's velocity unit.

Index	606B _h
Name	velocity_demand_value
Object Code	VAR
Data Type	INT32
Access	RO
PDO Mapping	YES
Units	speed units
Value Range	--
Default Value	--

velocity_actual_value

The master can read velocity_actual_value to know the current velocity of the servo motor. The unit of this parameter is user's velocity unit.

Index	606C _h
Name	velocity_actual_value
Object Code	VAR
Data Type	INT32
Access	RO
PDO Mapping	YES
Units	speed units
Value Range	--
Default Value	--

velocity_window

The difference between velocity_actual_value (606C_h) and target_velocity (60FF_h) is defined as actual velocity error window. If the actual velocity error window is always smaller than velocity_window (606D_h) within the time set by velocity_window_time (606E_h), then bit 10 of status word (target_reached) will be set to indicate that the set velocity has been reached.

Index	606D _h
Name	velocity_window
Object Code	VAR

Data Type	UINT16
Access	RW
PDO Mapping	YES
Units	speed units
Value Range	--
Default Value	20 R/10min

velocity_window_time

Velocity window comparator is composed of velocity_window_time and velocity_window.

Index	606E _h
Name	velocity_window_time
Object Code	VAR
Data Type	UINT16
Access	RW
PDO Mapping	YES
Units	ms
Value Range	--
Default Value	0

velocity_threshold

Velocity_threshold indicates a range close to zero speed in order to define if the servo motor has already stopped.

Index	606F _h
Name	velocity_threshold
Object Code	VAR
Data Type	UINT16
Access	RW
PDO Mapping	YES
Units	speed units
Value Range	--
Default Value	50

velocity_threshold_time

Velocity_threshold_time is used to set the shortest time when servo motor's speed is under velocity threshold. The unit is: ms. When the time that servo motor's speed is lower than the

threshold is more than velocity_threshold_time, status word bit 12 (speed is zero) will be set as 1.

Index	6070 _h
Name	velocity_threshold_time
Object Code	VAR
Data Type	UINT16
Access	RW
PDO Mapping	YES
Units	ms
Value Range	--
Default Value	0

Max profile velocity

The object max profile velocity is the speed that the motor cannot exceed. Its unit is the unit of customer's speed.

Index	607F _h
Name	Max profile velocity
Object Code	VAR
Data Type	UINT32
Access	RW
PDO Mapping	YES
Units	speed units
Value Range	--
Default Value	0

target_velocity

target_velocity is the reference speed.

Index	60FF _h
Name	target_velocity
Object Code	VAR
Data Type	INT32
Access	RW
PDO Mapping	YES
Units	speed units
Value Range	--

Default Value 0

6.9 PROFILE TORQUE MODE

6.9.1 Flow Chart of PROFILE TORQUE MODE

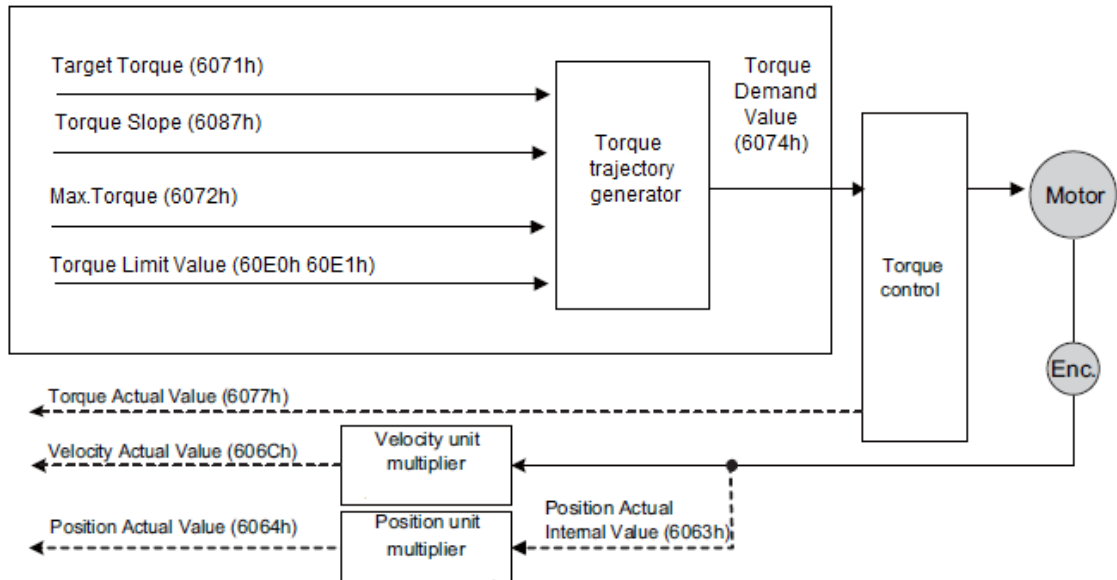

6.9.2 Control Word

15 ~ 9	8	7 ~ 4	3 ~ 0
*	Halt	*	*

*: refer to previous chapters

bit	Value	Definition
8	0	The motion shall be executed 8 or continued
	1	Axis shall be stopped according to the halt option code (605Dh)

6.9.3 Status Word

15 ~ 14	13	12	11	10	9 ~ 0
*	*	*	*	Target reached	*

*: refer to previous chapters

bit	Value	Definition
10	0	Target torque not reached

bit	Value	Definition
	1	Target torque reached

6.9.4 Related Parameters

Index	Object	Name	Type	Attr.
6071 _h	VAR	target_torque	INT16	RW
6072 _h	VAR	Max torque	UINT16	RW
6074 _h	VAR	torque_demand	INT16	RO
6077 _h	VAR	torque_actual_value	INT16	RO
6087 _h	VAR	torque_slope	UINT32	RW

target_torque

The master can send a torque reference to the drive through target_torque, the unit is 0.1% of the rated motor torque, which is indicated on the motor nameplate.

Index	6071 _h
Name	target_torque
Object Code	VAR
Data Type	INT16
Access	RW
PDO Mapping	YES
Units	0.1% rated torque
Value Range	--
Default Value	--

Max torque

Max torque, the maximum torque allowed by the motor during operation, the unit is 0.1% of the rated torque of the motor.

Index	6072 _h
Name	Max torque
Object Code	VAR
Data Type	UINT16
Access	RW
PDO Mapping	YES
Units	0.1% rated torque
Value Range	--
Default Value	0

torque_demand

The output of the torque reference generator. The drive generates the command slope according to the value of target_torque and torque_slope.

Index	6074 _h
Name	torque_demand
Object Code	VAR
Data Type	INT16
Access	RO
PDO Mapping	YES
Units	0.1% rated torque
Value Range	--
Default Value	--

torque_actual_value

The master can get the current output torque of the motor by reading torque_actual_value. Its unit is 0.1% of rated torque of the motor.

Index	6077 _h
Name	torque_actual_value
Object Code	VAR
Data Type	INT16
Access	RO
PDO Mapping	YES
Units	0.1% rated torque
Value Range	--
Default Value	--

torque_slope

The master can set the change speed of torque reference via torque_slope. Its unit is 0.1% of rated torque per second.

Index	6087 _h
Name	torque_slope
Object Code	VAR
Data Type	UINT32
Access	RW
PDO Mapping	YES

Units	0.1% rated torque per second
Value Range	--
Default Value	--

6.10 PROFILE POSITION MODE

6.10.1 Flow Chart of PROFILE POSITION MODE

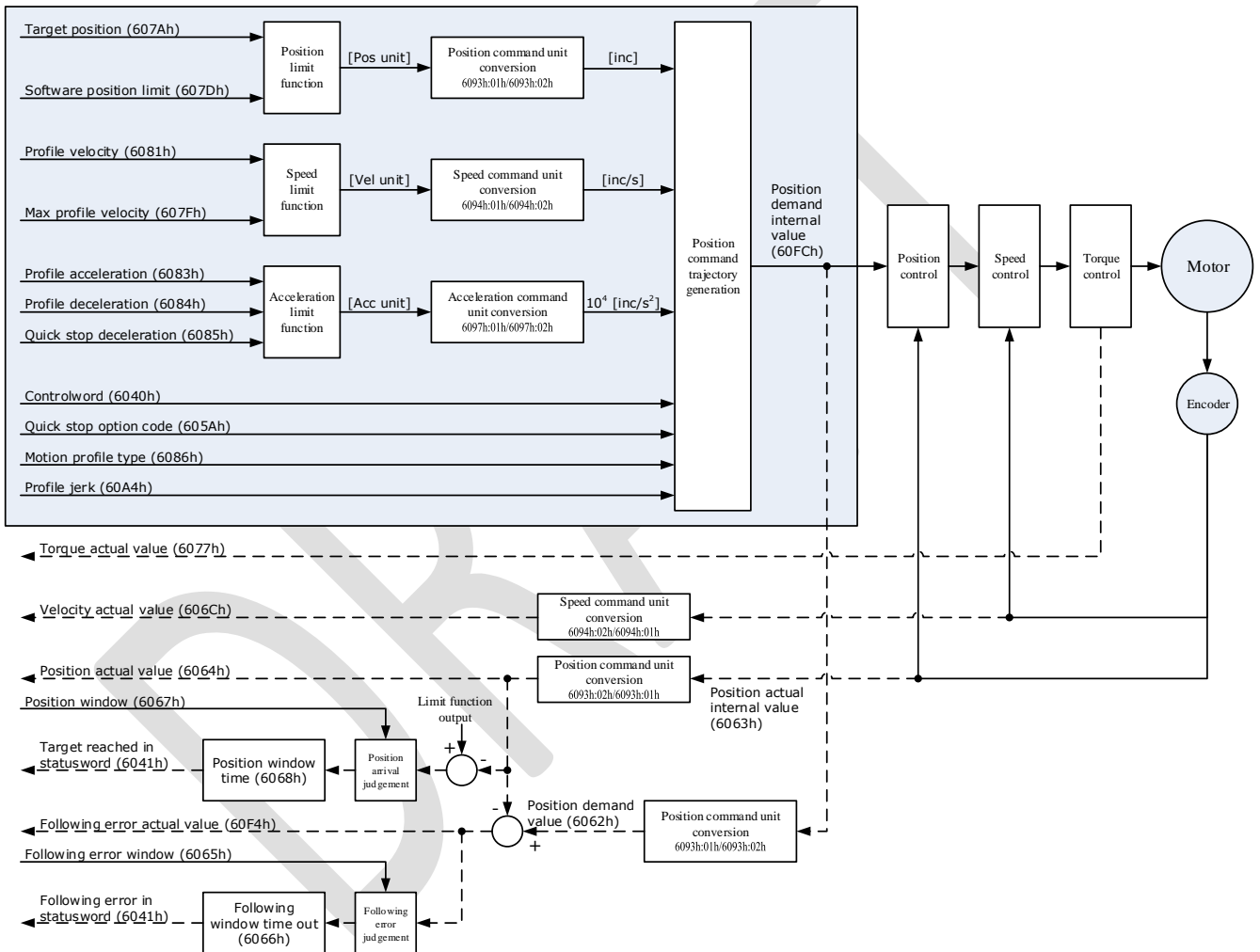

6.10.2 Control Word

15 ~ 9	8	7	6	5	4	3 - 0
*	Halt	*	abs / rel	change set immediately	New set-point	*

*: refer to previous chapters

Name	Value	Description
New set-point	0	Does not assume <i>target position</i>
	1	Assume <i>target position</i>
Change set immediately	0	Finish the actual positioning and then start the next positioning
	1	Interrupt the actual positioning and start the next positioning
abs / rel	0	<i>Target position</i> is an absolute value
	1	<i>Target position</i> is a relative value
Halt	0	Execute positioning
	1	Stop axle with <i>profile deceleration</i> (if not supported with <i>profile acceleration</i>)

6.10.3 Staus Word

15 ~ 14	13	12	11	10	9 ~ 0
*	Following error	Set_point acknowledge	*	Target reached	*

*: refer to previous chapters

Name	Value	Description
Target reached	0	Halt = 0: <i>Target position</i> not reached Halt = 1: Axle decelerates
	1	Halt = 0: <i>Target position</i> reached Halt = 1: Velocity of axle is 0
Set-point acknowledge	0	Trajectory generator has not assumed the positioning values (yet)
	1	Trajectory generator has assumed the positioning values
Following error	0	No following error
	1	Following error

6.10.4 Related Parameters

Index	Object	Name	Type	Attr.
607A _h	VAR	target_position	INT32	RW
6081 _h	VAR	profile_velocity	UINT32	RW
6082 _h	VAR	end_velocity	UINT32	RW
6083 _h	VAR	profile_acceleration	UINT32	RW
6084 _h	VAR	profile_deceleration	UINT32	RW
6085 _h	VAR	quick_stop_deceleration	UINT32	RW
6086 _h	VAR	motion_profile_type	INT16	RW
60A4-01 _h	VAR	Profile_jerk1	UINT32	RW

target_position

The object target_position is the given target position, which (target_position) is interpreted either as an absolute or relative position. This depends on bit 6 (relative) of the object control word.

Index	607A _h
Name	target_position
Object Code	VAR
Data Type	INT32
Access	RW
PDO Mapping	YES
Units	position units
Value Range	--
Default Value	0

profile_velocity

The object profile_velocity specifies the speed that usually is reached during a positioning motion at the end of the acceleration ramp.

Index	6081 _h
Name	profile_velocity
Object Code	VAR
Data Type	UINT32
Access	RW
PDO Mapping	YES
Units	speed units
Value Range	--
Default Value	0

end_velocity

End_velocity is the speed when servo motor reaches the target_position. Normally we set this value as 0 in order to stop the servo motor when the servo motor reaches the requested position. But in continuous multiple position, this value could be set as a non-zero value.

Index	6082 _h
Name	end_velocity
Object Code	VAR
Data Type	UINT32
Access	RW
PDO Mapping	YES

Units	speed units
Value Range	--
Default Value	0

profile_acceleration

Profile_acceleration is the acceleration speed before reaching the target position.

Index	6083 _h
Name	profile_acceleration
Object Code	VAR
Data Type	UINT32
Access	RW
PDO Mapping	YES
Units	acceleration units
Value Range	--
Default Value	100000 R/10min/s

profile_deceleration

Profile_deceleration is the deceleration speed before reaching the target position.

Index	6084 _h
Name	profile_deceleration
Object Code	VAR
Data Type	UINT32
Access	RW
PDO Mapping	YES
Units	acceleration units
Value Range	--
Default Value	100000 R/10min/s

quick_stop_deceleration

Quick_stop_deceleration is the deceleration speed in Quick Stop.

Index	6085 _h
Name	quick_stop_deceleration
Object Code	VAR
Data Type	UINT32

Access	RW
PDO Mapping	YES
Units	acceleration units
Value Range	--
Default Value	200000 R/10min/s

motion_profile_type

Motion_profile_type is used to select the motion curve. Now we only support trapezoid speed curve (set as 0) and S speed curve (set as 2).

Index	6086 _h
Name	motion_profile_type
Object Code	VAR
Data Type	INT16
Access	RW
PDO Mapping	YES
Units	--
Value Range	0or2
Default Value	0

profile_jerk1

Profile_jerk1 is used to set the jerk of speed profile. The value is smaller, the speed changing is more smooth.

Index	60A4 -01 _h
Name	profile_jerk1
Object Code	VAR
Data Type	UINT32
Access	RW
PDO Mapping	YES
Units	jerk units
Value Range	1-20
Default Value	5pulse/(s*100μs*100μs)

6.10.5 Function Description

When the speed profile is trapezia (motion_profile_type=0), two different ways to apply target positions are supported:

Single-step

When the current position is being executed, the controller resends a new position, and at the same time gives a rising edge to bit4 of the controlword, the drive then will re-plan and execute based on the latest position and speed.

Continuous-step

After the motor reaches the target position, the drive informs the host of "target position reached", and then gets a new target position and starts motion. Before getting a new target position, the motor speed is usually zero.

Both of the above two methods can be changed in real time by bit4 and bit5 of the controlword and bit12 (set_point_acknowledge) of the status word statusword. The position control being executed can be interrupted through the handshake mechanism, and the target position can be reset by using these few words.

Single-step setting procedure

1. Set the NMT status into Operational and set the control mode parameter (6060 h) as 1.
2. According to the actual demand, we could set the target position (target_position: 607A h) and so on.
3. We need set bit4 (new_set_point) of the control word as 1, bit 5 (change_set_immediately) as 0, bit 6 (absolute/comparative) should be determined by whether the reference target position is an absolute value or a comparative value.
4. We use bit12 (set_point_acknowledge) of the status word to configure the servo drive acknowledge mechanism. And then we start to operate position control.
5. After reaching the target position, servo drive will need to respond through bit 10 (target_reached) of the status word. And then servo drive will follow the program to keep moving or accept new target position.

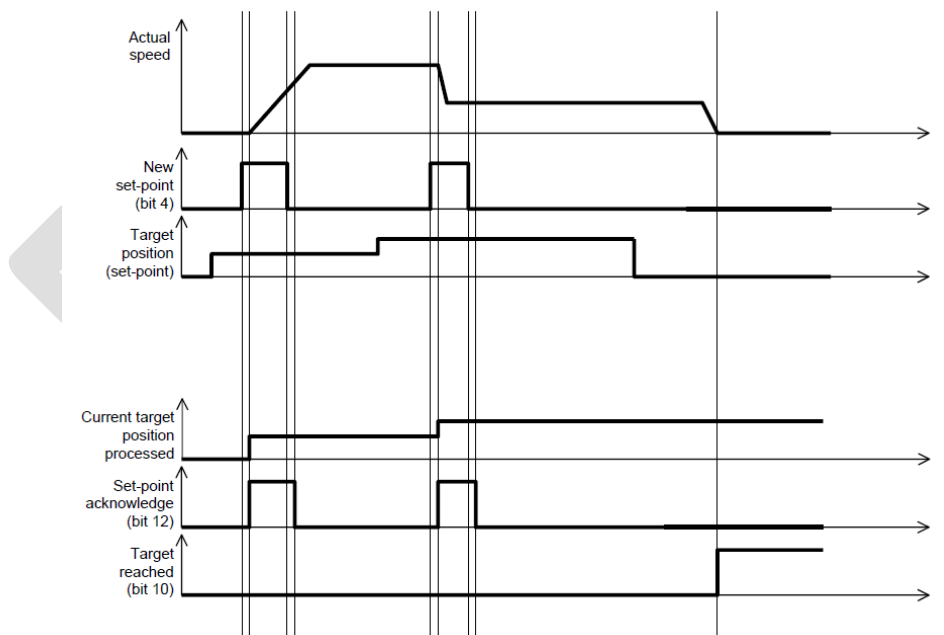

Continuous-step setting procedure

6. At first, set NMT as Operational and control mode parameter (6060 h) as 1.
7. According to actual demand, set the first target position (target_position: 607A h), target speed, acceleration/deceleration and other Related Parameters.
8. Set bit 4 (new_set_point) of control word as 1. Set bit 5 (change_set_immediately) as 0. Set bit6 (absolute/comparative) according to the type of object position.
9. Set bit 12 (set_point_acknowledge) of the status word and then start to operate position control.
10. Set the second target position (target_position: 607A h), target speed, acceleration/deceleration speed.

11. Set bit4 (new_set_point) as 1, bit 5 (change_set_immediately) as 0. Set Bit6 (absolute/comparative) according to the target position type.
12. After reaching the first target position, the servo drive will not stop and keep moving toward the second target position. After reaching the second target position, the servo drive will respond through status word bit 10 (target_reached). Then the servo motor will follow the program to keep moving or accept new target position.

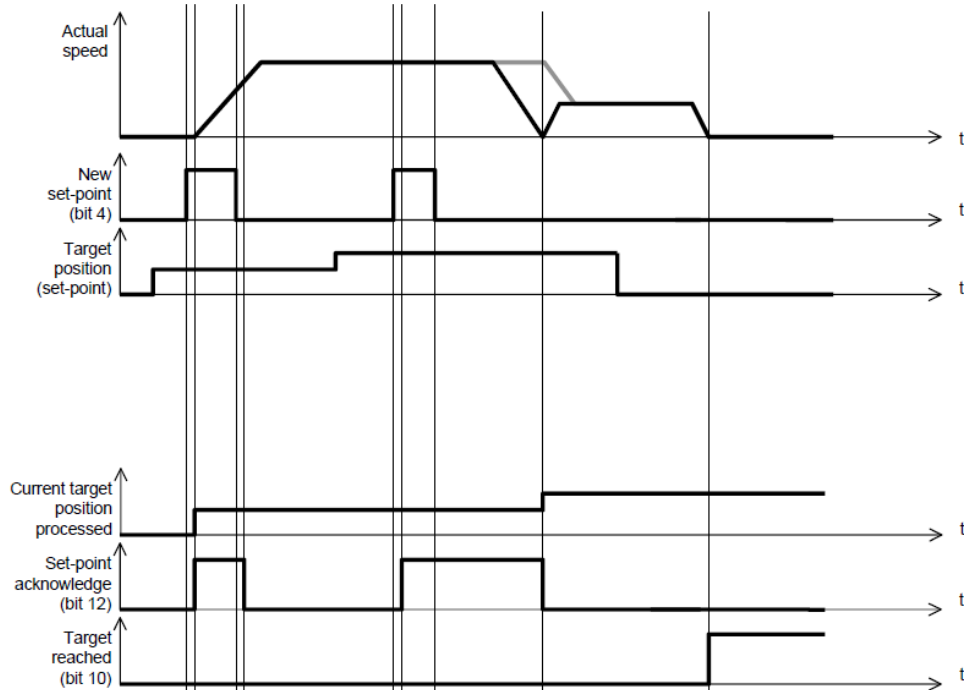

When the speed profile is S (motion_profile_type=2), only **Continuous-step setting** is available. 6083h (profile_acceleration) limits max acceleration, and 6081h (profile_velocity) limits max speed. 60A4-01 h (VAR Profile_jerk1) limits the jerk. Only symmetrical S linear is available currently.

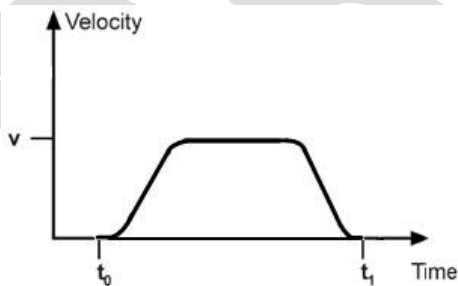

6.11 INTERPLATION POSITION MODE

6.11.1 Flow Chart of INTERPLATION POSITION MODE

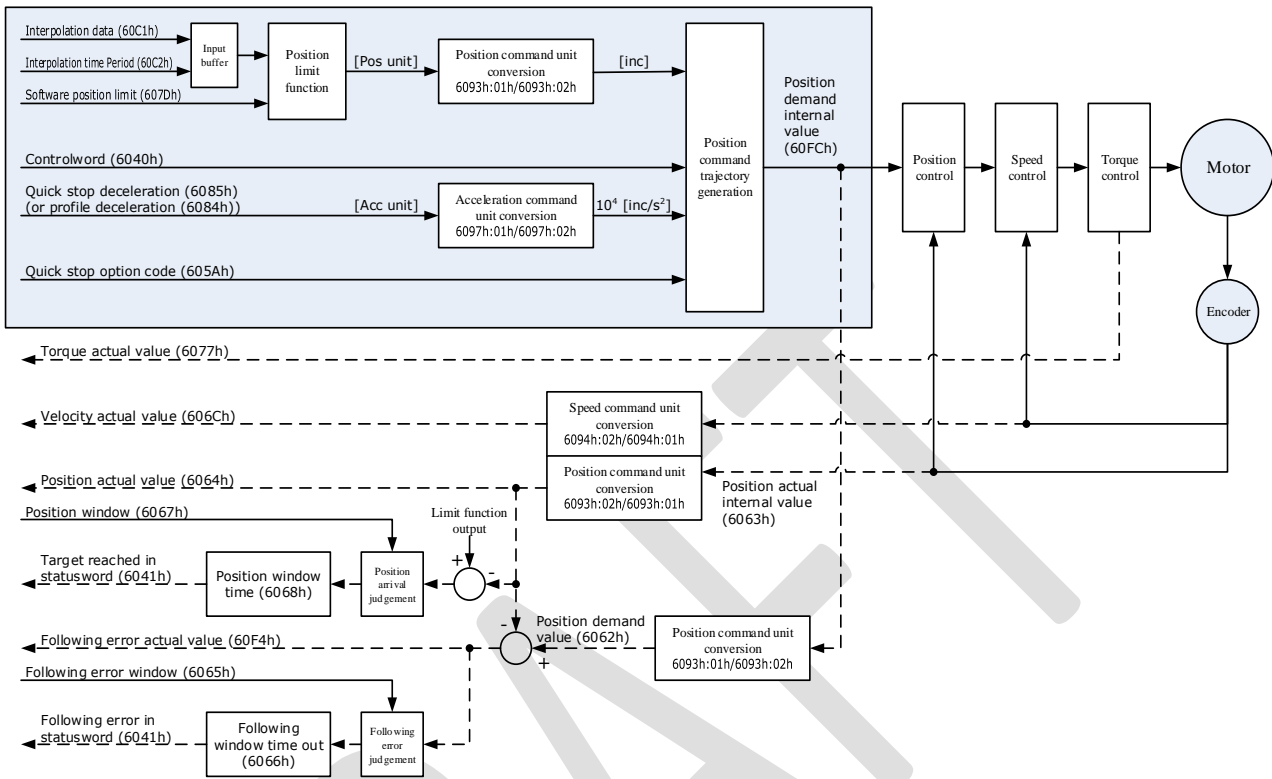

6.11.2 Control Word

15 ~ 9	8	7	6	5	4	3 ~ 0
*	Halt	*	*	*	Enable ip mode	*

*: refer to previous chapters

Name	Value	Description
Enable ip mode	0	Interpolated position mode inactive
	1	Interpolated position mode active
Halt	0	Execute the instruction of bit 4
	1	Stop axle

6.11.3 Status Word

15 ~ 14	13	12	11	10	9 ~ 0
*	*	ip mode active	*	Target reached	*

*: refer to previous chapters

Name	Value	Description
Target reached	0	Halt = 0: Position not (yet) reached Halt = 1: Axle decelerates
	1	Halt = 0: Position reached Halt = 1: Axle has velocity 0
ip mode active	0	Interpolated position mode inactive
	1	Interpolated position mode active

6.11.4 Related Parameters

Index	Object	Name	Type	Attr.
60C0 _h	VAR	Interpolation sub mode select	INT16	RW
60C1 _h	ARRAY	Interpolation data record	INT32	RW
60C2 _h	RECORD	Interpolation time period		RW

Interpolation sub mode select

Interpolation sub mode select is used to select the method of interpolation under IP control. **Only the linear interpolation is available.**

Index	60C0h
Name	Interpolation sub mode select
Object Code	VAR
Data Type	INT16
Access	RW
PDO Mapping	NO
Value Range	0
Default Value	0
Comment	0: Linear interpolation

Interpolation data record

Interpolation data record is used to reserve interpolation position data. **Our servo drive's interpolation command only uses the first data whose subindex is 1.**

Index	60C1h
Subindex	0
Object Code	ARRAY
Data Type	INT32
Access	RO
PDO Mapping	YES

Value Range	INT8
Default Value	2
Comment	number of entries

Index	60C1h
Subindex	1
Object Code	ARRAY
Data Type	INT32
Access	RW
PDO Mapping	YES
Value Range	INT32
Default Value	0
Comment	the first parameter of ip function

Index	60C1h
Subindex	2
Object Code	ARRAY
Data Type	INT32
Access	RW
PDO Mapping	YES
Value Range	INT32
Default Value	0
Comment	The second parameter of ip function

Interpolation time period

Interpolation time period is used to reserve the time data of interpolation position.

Index	60C2h
Object Code	RECORD
Data Type	Interpolation time period record (0080h)
Category	Conditional: mandatory if ip, csp, csv or cst mode is supported

Index	60C2h
Subindex	0

Object Code	RECORD
Data Type	UINT8
Access	C
PDO Mapping	NO
Value Range	02
Default Value	02
Comment	Highest sub-index supported

Index	60C2h
Subindex	01
Object Code	RECORD
Data Type	UINT8
Access	RW
PDO Mapping	YES
Value Range	UINT8
Default Value	01
Comment	Interpolation time period value

Index	60C2h
Subindex	02
Object Code	RECORD
Data Type	INT8
Access	RW
PDO Mapping	YES
Value Range	-128 to +63
Default Value	-3
Comment	Interpolation time index

6.11.5 Functional Description

Interpolation principle of IP mode:

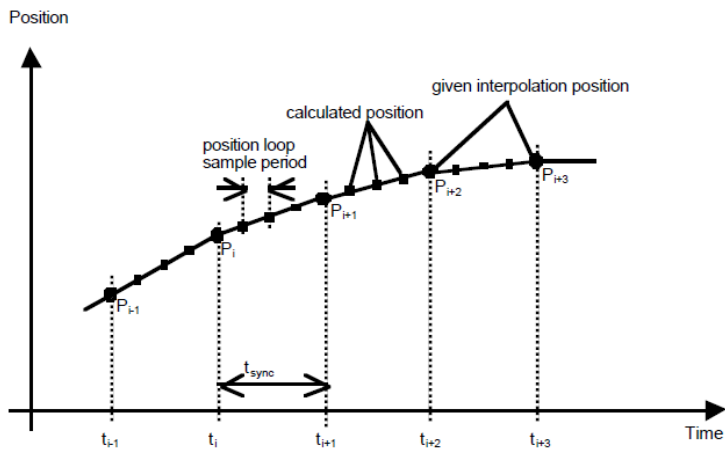

P_i : interpolation position set by the host; t_{sync} : sync period

Explanations

1. In our servo drive, there is no buffer for position data so in IP control, all the position data needs to be updated by the host controller. To achieve synchronization, host controllers need to send the updated position at first and then use SYNC signal to make all the servo drive receive the synchronization information. After receiving the synchronization information, servo drive will synchronize its internal clock. Please notice that the sync period should be not bigger than interpolation cycle period in order to keep the updating of interpolation data.
2. In IP mode, the host controller should at first set the servo's PDO receiving method into sync mode (use SYNC frame to receive and send synchronization information). Since the SYNC is broad casted, each servo drive will only update PDO data after receiving this signal.
3. Before SYNC is sent, host controller should send position data X_i and Controlword to the servo drive.
4. When there is data delay, servo drive will use the last sync date to do interpolation.
5. After one IP period is ended, if there is no further data updating, interpolation cycle overtime alarm (A 69) will happen. Then servo drive will stop.

Recommended RPDO configuration:

- When you use only one RPDO

Control word (index: 6040h, subindex: 0h)	32bit (index:60C1h, subindex:01h)	position reference
-------------------------------------------------	-----------------------------------------	-----------------------

- When you use two RPDOs

Control (index:6040h, subindex:0h)	word 32bit (index:60C1h, subindex:01h)	position reference
------------------------------------------	----------------------------------------------	-----------------------

Configuration process:

1. Configure PDO. (RPDO1 is configured as index: 6040h, subindex: 0h, RPDO2 is configured as index 60c1h, subindex: 1h)
2. Set interpolation cycle (60C2-01h), in micro second (ms).
3. Set PDO as Sync mode (Set the object dictionary (index: 1400h, subindex: 02h) as 1. Set object dictionary (index: 1401h, subindex: 02h) as 1). If sending PDO needs to be in sync mode as well, we need to set object dictionary (index: 1800h, subindex: 02h) as 1 and (index:1801h,subindex:02h) as 1 as well.
4. Set the control mode to PI mode (set the object dictionary (index: 6060h, subindex:0h) to 7);

5. NMT starts node.

6.12 Torque Limit Function

In CANOPEN bus mode, torque limit function is restricted by 0x60E0 and 0x60E1 as below.

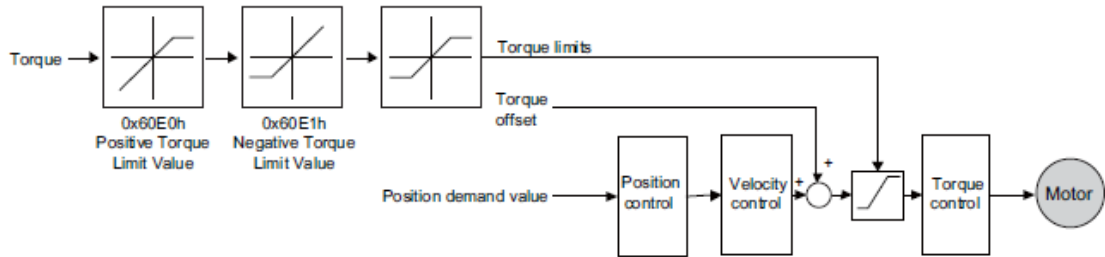

PosTorLimit(0x60E0)

PosTorLimit is the positive torque limit, unit: 0.1% rated torque

Index	60E0h
Name	PosTorLimit
Object Code	VAR
Data Type	UINT16
Access	RW
PDO Mapping	YES
Value Range	0-3000
Default Value	3000

NegTorLimit(0x60E1)

NegTorLimit is the negative torque limit, unit: 0.1% rated torque

Index	60E1h
Name	NegTorLimit
Object Code	VAR
Data Type	UINT16
Access	RW
PDO Mapping	YES
Value Range	0-3000
Default Value	3000

6.13 DIGITAL INPUT /OUTPUT

60FE (Physical outputs)

In some cases, some switches (i.e. the origin signal and limit signal) are not sent to the servo drive directly, but sent by the host. You need to use the object 60FE-01h (Physical outputs) to transfer the relevant signals.

Index	60FE _h
Name	Digital outputs
Object Code	ARRAY
No. of Elements	2
Data Type	UINT32

Sub-Index	01 _h
Name	Physical outputs
Object Code	VAR
Data Type	UINT32
Access	RW
PDO Mapping	YES
Default Value	0

Sub-Index	02 _h
Name	Bit mask
Object Code	VAR
Data Type	UINT32
Access	RW
PDO Mapping	YES
Default Value	0

Bit17	Bit28	Bit29	Bit30	Bit31
reserved	Remote0	Remote1	Remote2	reserved

The bit28-bit30 bits of this object correspond only to the input port of CN1 respectively, and then you need to configure the corresponding function of the input port through Pn511 or invert it through 517.

60FD (Physical outputs)

Sometimes, the host controller may read the object 60FDh (Digital Inputs) to monitor the switching on-off inputs of the drive, which are defined as follows:

Index	60FD _h
-------	-------------------

Name	Digital outputs
Object Code	Variable
Data Type	UINT32

Sub-Index	00 _h
Name	Physical outputs
Object Code	VAR
Data Type	UINT32
Access	RO
PDO Mapping	YES
Default Value	0

Bit0	Bit1	Bit2	Bit3-15	Bit16	Bit17	Bit18
negative limit switch	positive limit switch	home switch	reserved	CN1_in1	CN1_in2	CN1_in3
Bit19	Bit20	Bit21	Bit22	Bit23	Bit24-31	
CN1_in4	CN1_in5	CN1_in6	CN1_in7	CN1_in8	reserved	

6.14 Functions of TouchProbe

You may use the following trigger events to latch the feedback motor position.

- TouchProbe input 1 (TP1) triggered
- TouchProbe input 2 (TP2) triggered
- Trigger by using C pulse signal

The latch function of two TouchProbes can be used at the same time:

- Latch control object: 60B8h (bit0 to bit7)
- Latch state object: 60B9h (bit0 to bit7)
- The locked position is always stored in the TouchProbe1 position value (60BAh and 60BBh).
- Trigger signal: C pulse signal or EXT1 signal of the encoder

The objects involved in this function are listed in table below:

Index 1	Sub-index	Name	Visit	Data Type	PDO Mapping	Default
60B8	00	Touch Probe Function	RW	UINT16	Yes	–
60B9	00	Touch Probe Status	RO	UINT16	Yes	–
60BA	00	TouchProbePos1PosValue	RO	INT32	Yes	–

Index 1	Sub-index	Name	Visit	Data Type	PDO Mapping	Default
60BB	00	TouchProbeNeg1PosValue	RO	INT32	Yes	–
60BC	00	TouchProbePos2PosValue	RO	INT32	Yes	–
60BD	00	TouchProbeNeg2PosValue	RO	INT32	Yes	–

Example of the execution process of Touch Probe:

- Single Trigger Mode (60B8h bit1=0, or bit9=0)

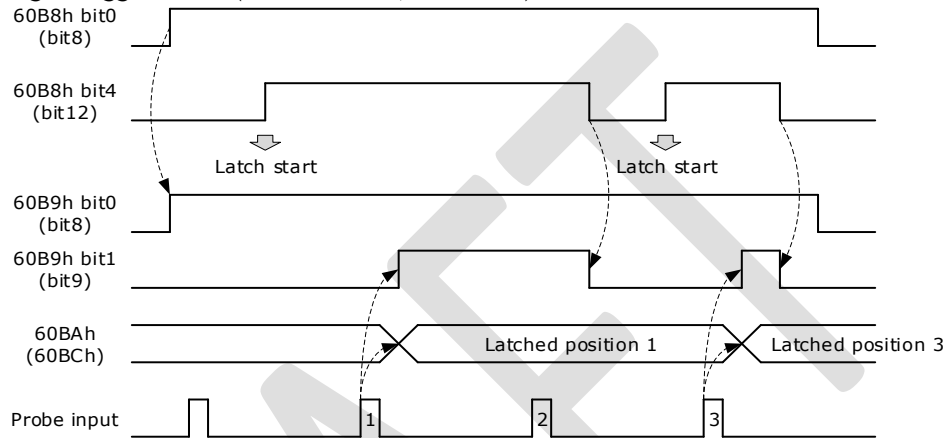

- Continuous Trigger Mode (60B8h bit1=1, or bit9=1)

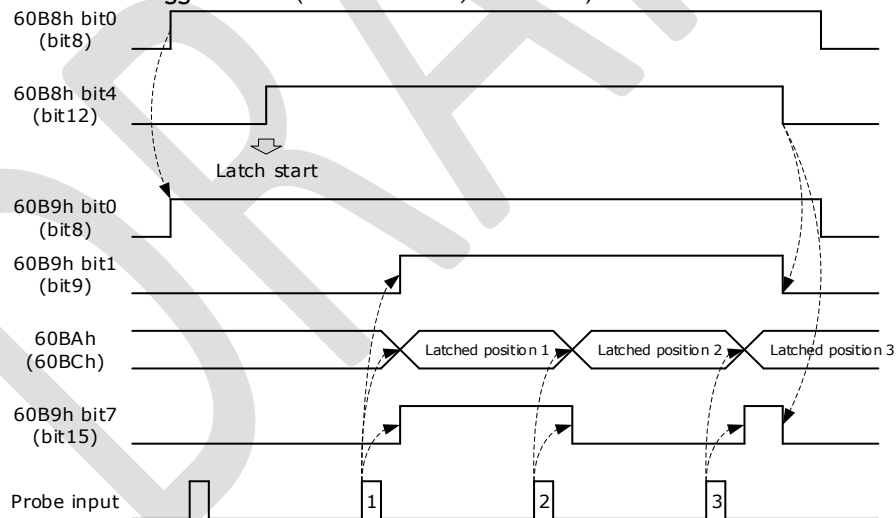

60B8h: Touch Probe Function

The object is configured to the Touch Probe Function.

Index	Subindex	Name	Access	Data Type	Unit	Range	Default
60B8	00	Touch Probe Function	RW	UINT16	–	0 to 0xFFFF	0

Each bit of Touch Probe Function (60B8h) is described as follows:

Bit	Value	Definition
0	0	Probe 1 not enabled
	1	Probe 1 enabled
1	0	Single trigger, probe 1 is triggered only when the trigger signal is valid for the first time
	1	Continuous trigger, probe 1 is triggered every time the trigger signal is valid
2	0	External IO signal, used as probe 1 trigger signal
	1	C pulse, used as the trigger signal of probe 1
3	0	Reserved
4	0	Not enable the rising edge latch position of probe 1
	1	Enable latch position on rising edge of probe 1
5	0	Not enable the latch position of probe 1 falling edge
	1	Enable the latch position of probe 1 falling edge
6, 7	0	Reserved
8	0	Probe 2 not enabled
	1	Probe 2 enabled
9	0	Single trigger, probe 2 is triggered only when the trigger signal is valid for the first time
	1	Continuous trigger, probe 2 is triggered every time the trigger signal is valid
10	0	External IO signal, used as probe 1 trigger signal
	1	C pulse, used as the trigger signal of probe 1
11	0	Reserved
12	0	Not enable the rising edge latch position of probe 2
	1	Enable latch position on rising edge of probe 2
13	0	Not enable the latch position of probe 2 falling edge
	1	Enable the latch position of probe 2 falling edge
14, 15	0	Reserved

60B9h: Touch Probe Status

Touch Probe Status (60B9h) indicates the touch probe status.

Index	Sub-index	Name	Visit	Data Type	Unit	Range	Default
60B9	00	Touch Probe Status	RO	UINT16	–	–	–

Each bit of Touch Probe Function (60B9h) is described as follows:

Bit	Value	Definition
0	0	Probe 1 not enabled
	1	Probe 1 enabled
1	0	Probe 1 rising edge position latch has not been executed
	1	Probe 1 rising edge position latch has been executed
2	0	Probe 1 falling edge position latch has not been executed
	1	Probe 1 falling edge position latch has been executed
3 to 5	0	Reserved
6,7	0	In continuous mode, bit6 and bit7 record the times that the function of probe 1 has been executed; the value is counted cyclically between 0 and 3.
8	0	Probe 2 not enabled
	1	Probe 2 enabled
9	0	Probe 2 rising edge position latch has not been executed
	1	Probe 2 rising edge position latch has been executed
10	0	Probe 2 falling edge position latch has not been executed
	1	Probe 2 falling edge position latch has been executed
11 to 13	0	Reserved
14, 15	0	In continuous mode, bit14 and bit15 record the times that the function of probe 2 has been executed; the value is counted cyclically between 0 and 3.

60BAh: TouchProbePos1PosValue

TouchProbePos1PosValue (60BAh) indicates the latch location when the Touch Probe1 trigger condition occurs.

Index	Sub-index	Name	Visit	Data Type	Unit	Range	Default
60BA	00	TouchProbePos1PosValue	RO	INT32	–	–	–

60BBh: TouchProbeNeg1PosValue

TouchProbeNeg1PosValue (60BBh) indicates the latch location when the trigger condition for Touch Probe1 falling edge occurs.

Index	Sub-index	Name	Visit	Data Type	Unit	Range	Default
60BB	00	TouchProbeNeg1PosValue	RO	INT32	–	–	–

60BCh: TouchProbePos2PosValue

TouchProbePos2PosValue (60BCh) indicates the latch location when the Touch Probe2 trigger condition occurs.

Index	Sub-index	Name	Visit	Data Type	Unit	Range	Default
60BC	00	TouchProbePos2PosValue	RO	INT32	–	–	–

60BDh: TouchProbeNeg2PosValue

TouchProbeNeg2PosValue (60BDh) indicates the latch location when the trigger condition for Touch Probe2 falling edge occurs.

Index	Sub-index	Name	Visit	Data Type	Unit	Range	Default
60BD	00	TouchProbeNeg2PosValue	RO	INT32	–	–	–

Pn331 and Pn332

You can allocate the TouchProbe functions by Pn331, and set Touch Probe Digital Input Filtering Time by Pn332. The Related Parameters are as following:

Para	Name	Range	Unit	Default	When Enabled
Pn331.0	CN1-18 Signal Allocation	0 to 2	–	0	After restart
Pn331.1	CN1-19 Signal Allocation	0 to 2	–	1	
Pn332	Touch probe Input Signal Filtering Time	0 to 1000	10 ns	0	Immediately

The signal allocation instructions for Touch probe 1 and Touch probe 2 are listed in table below.

Para	Setting	Meaning	When Enabled
Pn331.0	0	Allocate Touch probe 1 signal to pin CN1-18	After restart
	1	Allocate Touch probe 2 signal to pin CN1-18	
	2	Not allocated	
Pn331.1	0	Allocate Touch probe 1 signal to pin CN1-19	
	1	Allocate Touch probe 1 signal to pin CN1-19	
	2	Not allocated	

Pn333

You can select whether to invert the Touch Probe 1 and Touch Probe 2 signals through the parameter Pn333. In general, it needs to be set according to the actual input signal level.

Para	Setting	Meaning	When Enabled
Pn333.0	0	Do not invert CN-18 signal (take effective when low level)	After restart
	1	Invert CN-18 signal (take effective when high level)	
Pn333.1	0	Do not invert CN-19 signal (take effective when low level)	
	1	Invert CN-19 signal (take effective when high level)	

6.15 Soft Limit Function

Software Position Limit defines the maximum and minimum absolute position commands. Every target position is checked against these limits. The limit positions are specified in user-defined position reference units, the same as for target positions, and are always relative to the machine home position. Before comparing with Target position, you need to use Home Offset to correct the position limit.

- corrected min position limit = min position limit - home offset
- corrected max position limit = max position limit - home offset

The software position limits are enabled at the following conditions:

- When homing is completed
- corrected min position limit < corrected max position limit

When the servo is not homed, if min position limit < max position limit, the servo takes max position limit and min position limit as the position limit; otherwise, the position command is not restricted by the position limit.

Index	Sub-index	Name	Visit	Data Type	Unit	Range	Default
607D	00	Software position	RO	UINT8	–	0 - 65535	0
	01	Min position limit	RW	INT32	–	- 2147483648 ~ 2147483647	–
	02	Max position limit	RW	INT32	–	- 2147483648 ~ 2147483647	–

Chapter 7 Trial Operation

7.1 Preparations for Trial Operation

The procedure for trial operation is given below.

Step	Contents	Refers to
1	Installation Install the Motor and Drive according to the installation conditions. First, operation is checked with no load. Do not connect the Motor to the machine.	Chapter 2
2	Wiring and Connections Wire and connect the Drive. First, Motor operation is checked without a load. Do not connect the CN1 connector on the Drive.	Chapter 3
3	Confirmations before Trial Operation	7.2
4	Power ON	–
5	Resetting the Absolute Encoder If an absolute encoder is used, it is necessary to reset the absolute encoder.	5.6

7.2 Inspections and Confirmations

To ensure safe and correct trial operation, check the following items before you start trial operation.

- Make sure that the Drive and Motor are installed, wired, and connected correctly.
- Make sure that the correct power supply voltage is supplied to the Drive.
- Make sure that there are no loose parts in the Motor mounting.
- If you are using a Motor with an Oil Seal, make sure that the oil seal is not damaged. Also make sure that oil has been applied.
- If you are performing trial operation on a Motor that has been stored for a long period of time, make sure that all Motor inspection and maintenance procedures have been completed.
- If you are using a Motor with a Holding Brake, make sure that the brake is released in advance. To release the brake, you must apply the specified voltage of 24 VDC to the brake, for details see the section 3.6.4 [Holding Brake Wiring](#).

7.3 Motor Operation without a Load

You use jogging for trial operation of the Motor without a load.

Jogging is used to check the operation of the Motor without connecting the Drive to the host controller. The Motor is moved at the preset jogging speed.



During jogging, the overtravel function is disabled.
Consider the range of motion of your machine when you jog the Motor.

7.3.1 Preparations

Always check the following before you execute jogging.

- The main circuit power supply must be ON.
- There must be no alarms.
- The Servo must not be in Safe State.
- The servo must be OFF.
- The jogging speed must be set considering the operating range of the machine.

Set the JOG speed by the following parameters

No.	Name	Range	Unit	Default	When enabled
Pn305	JOG speed	0 to 6000	rpm	500	Immediately
Pn306	Soft Start Acceleration Time	0 to 10000	ms	0	Immediately
Pn307	Soft Start Deceleration Time	0 to 10000	ms	0	Immediately

7.3.2 Applicable Tools

- Use the Panel Operator of the Drive
- Use the ESView V4 (Recommended)

7.3.3 JOG Operation

Use the Panel Operator of the Drive

Before performing the JOG operation by using the Panel Operator, you shall check and set the relevant parameters properly.

For the method of checking and setting parameters by using the Panel Operator, refers to the section 4.1.4 **Parameter Setting Mode**.

Following the below steps to jog the Motor.

Step 1 Press [M] key several times to select the Utility Function Mode.



Step 2 Press [▲] key or [▼] key to select the function number Fn002.



Step 3 Press [◀] key, and Panel Operator displays as below.



Lit for Servo OFF
Not lit for Servo ON

- Step 4 Press [M] key to Servo ON (supply power to Motor).
Press [M] key again to Servo OFF (not supply power to Motor).
- Step 5 Press [▲] key or [▼] key to run the Motor in forward or reverse direction.
Press and hold [▲] key or [▼] key to run the Motor continuously.

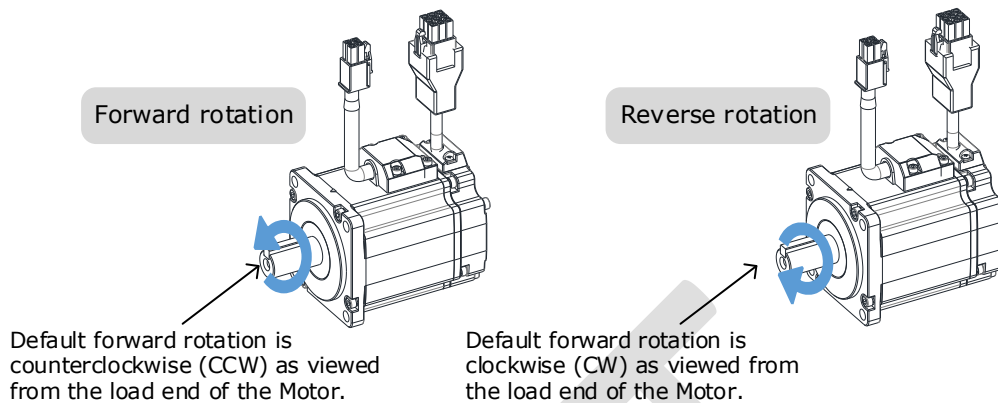

NOTE: The rotation direction of the Motor depends on the setting of Pn001.0 (CCW, CW). The figure above shows the default setting.

- Step 6 Press the [◀] key to return to the display of the Fn002.

---- End

Use ESView V4

The Motor will operate only while a button is clicked on the *ESView V4*.

- Step 1 Select **Run > JOG** in the **Menu Bar** of the *ESView V4* main windows.

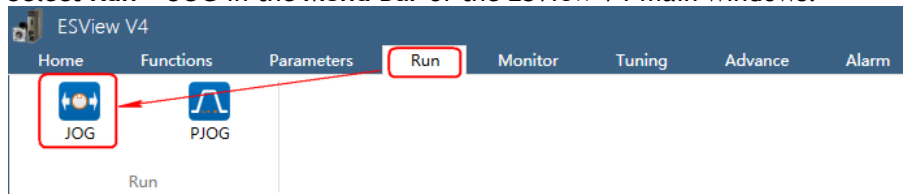

- Step 2 Read and follow the precautions in the warning box, and then click **OK**.

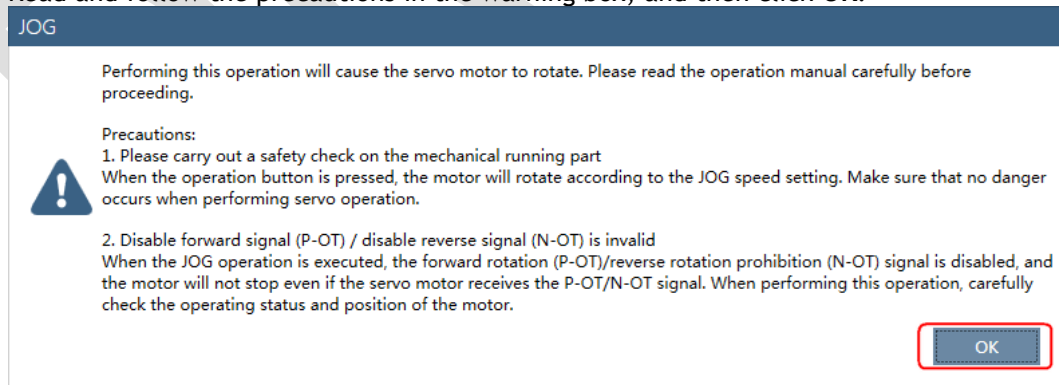

Step 3 Set the below parameters on the **JOG** dialog box.

AXIS			
EM3A-04ALA			
SETTINGS			
Pn305 JOG Speed	500	rpm	Range : 0 ~ 6000
Pn306 Soft Start Acceler...	0	ms	Range : 0 ~ 10000
Pn307 Soft Start Deceler...	0	ms	Range : 0 ~ 10000
Current speed: 0 rpm			
RUN			
Servo Off			

- Pn305 **JOG Speed**: set the speed for jogging the Motor.
- Pn306 **Soft Start Acceleration Time**: set the time it takes for the Motor runs to **JOG speed**.
- Pn307 **Soft Start Deceleration Time**: set the time it takes for the Motor stops from **JOG speed**.

Step 4 Click **Servo Off** / **Servo On** for supplying power to the Motor.

AXIS			
EM3A-04ALA			
SETTINGS			
Pn305 JOG Speed	50	rpm	Range : 0 ~ 6000
Pn306 Soft Start Acceler...	1000	ms	Range : 0 ~ 10000
Pn307 Soft Start Deceler...	1000	ms	Range : 0 ~ 10000
Current speed: 0 rpm			
RUN			
Servo Off			

Click the button or for running the Motor.

AXIS			
EM3A-04ALA			
SETTINGS			
Pn305 JOG Speed	50	rpm	Range : 0 ~ 6000
Pn306 Soft Start Acceler...	1000	ms	Range : 0 ~ 10000
Pn307 Soft Start Deceler...	1000	ms	Range : 0 ~ 10000
Current speed: 0 rpm			
RUN			
Servo On			

Click and hold the button or can run the Motor continuously, and the Motor can stop running when you release the button.

---- End

7.4 Motor Operation with a Load

7.4.1 Precautions



Operating mistakes that occur after the Motor is connected to the machine may not only damage the machine, but they may also cause accidents resulting in personal injury.



If you disabled the overtravel function for trial operation of the Motor without a load, enable the overtravel function (P-OT and N-OT signal) before you perform trial operation with the Motor connected to the machine in order to provide protection.

If you will use a holding brake, observe the following precautions during trial operation.

- Before you check the operation of the brake, implement measures to prevent vibration from being caused by the machine falling due to gravity or an external force.
- First check the Motor operation and brake operation with the Motor uncoupled from the machine. If no problems are found, connect the Motor to the machine and perform trial operation again.

Control the operation of the brake with the /BK (Brake) signal output from the Drive.



Failures caused by incorrect wiring or incorrect voltage application in the brake circuit may cause the Drive to fail, damage the Drive, damage the equipment, or cause an accident resulting in death or injury.

Observe the precautions and instructions for wiring and trial operation precisely as described in this manual.

7.4.2 Preparations

Always confirm the following before you perform the trial operation procedure for both the machine and Motor.

- Make sure that the Drive is connected correctly to both the host controller and the peripheral devices.
- Overtravel wiring
- Brake wiring
- Allocation of the /BK (Brake) signal to a pin on the I/O signal connector (CN1)
- Emergency stop circuit wiring
- Host controller wiring

7.4.3 Operation Procedure

Step 1 Enable the overtravel signals.

Refers to the section 5.3 [Overtravel Limi](#)

Step 2 Make the settings for the protective functions, such as the safety function, overtravel, and the brake.

- For details on overtravel settings, refers to the section 5.3 [Overtravel Limi](#).

- For details on holding brake settings, refers to the section 0  NOTE
- This setting is a percentage of the rated torque.
 - The default setting is 300%. This setting is large enough to allow you to operate the Motor at the maximum torque. However, the maximum stop torque that you can actually use is the maximum torque of the Motor.
- Holding Brake_

Step 3 Turn OFF the power supplies to the Drive.
The control power supply and main circuit power supply will turn OFF.

Step 4 Couple the Motor to the machine.

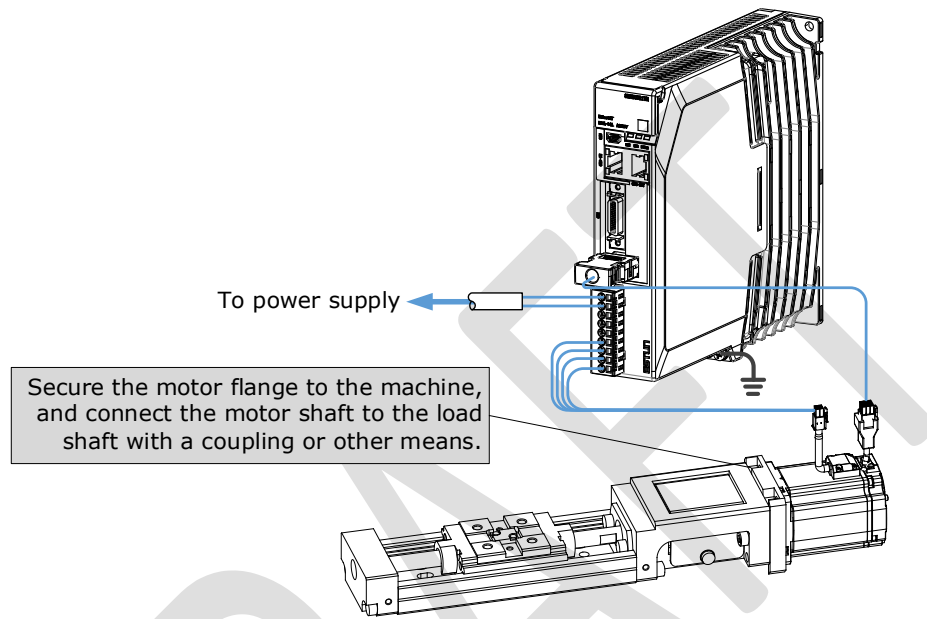

- Step 5 Turn ON the power supplies to the machine and host controller and turn ON the control power supply and main circuit power supply to the Drive.
- Step 6 Check the protective functions, such overtravel and the brake, to confirm that they operate correctly.
- Step 7 If necessary, adjust the servo gain to improve the Motor response characteristics. The Motor and machine may not be broken in completely for the trial operation. Therefore, let the system run for a sufficient amount of time to ensure that it is properly broken in.
- Step 8 For future maintenance, save the parameter settings with one of the following methods.
- Use the ESView V4 to save the parameters as a file.
 - Record the settings manually.

This concludes the procedure for trial operation with both the machine and Motor.

---- End

7.5 Program Jogging

You can use program jogging to perform continuous operation with a preset operation pattern, travel distance, movement speed, acceleration/deceleration time, waiting time, and number of movements.

You can use this operation when you set up the system in the same way as for normal jogging to move the Motor without connecting it to the host controller in order to check Motor operation and execute simple positioning operations.

7.5.1 Preparations

Always check the following before you execute program jogging.

- The parameters must not be written prohibited.
- The main circuit power supply must be ON.
- There must be no alarms.
- The Servo must not be in Safe State.
- The servo must be OFF.
- The range of machine motion and the safe movement speed of your machine must be considered when you set the travel distance and movement speed.
- There must be no overtravel.

7.5.2 Operation Description

Program jogging operation consists of two operation patterns (PJOG0 and PJOG1), you can set their relevant parameters respectively. Figure 7-1 shows an example of position-speed timing diagram in PJOG operation.

Figure 7-1 Position-speed timing diagram

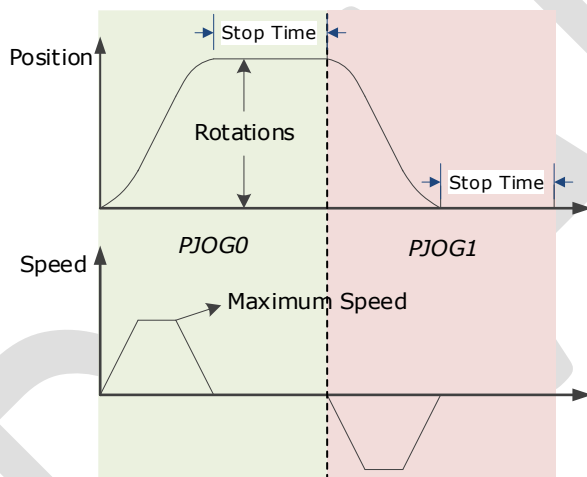

The Drive will operator the Motor repeatedly according to the parameter settings of the two operation patterns until you stop the program jogging operation manually.

You can set the parameters Pn164 and Pn168 to a negative value for reversing the Motor, so that there are four ways of the operation in the program jogging, as is shown inFigure 7-2.

Figure 7-2 Operation in the program jogging

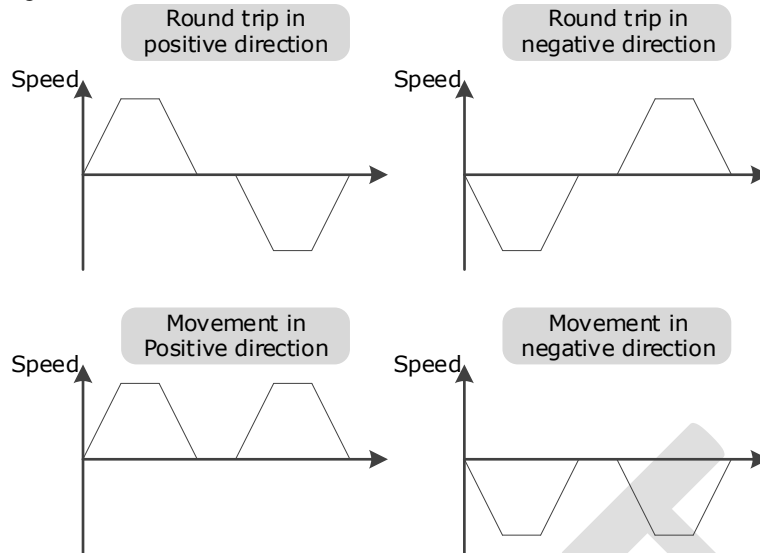

You shall set the Rotations (Pn164 and Pn168) and Max Speed (Pn165 and Pn169) to a proper value. If the Rotations is set too small or the Max Speed is set too large, it is possible that the maximum speed set cannot be reached. In this case, it is necessary to increase the Rotations or decrease the Max Speed.

7.5.3 Relevant Parameters

Parameter	Name	Range	Unit	Default	When Enabled
Pn164	Turns for PJOG0	-50 to 50	rotation	5	Immediately
Pn165	Max Speed for PJOG0	100 to 3000	rpm	1000	Immediately
Pn166	Acc./Dec. Time for PJOG0	50 to 2000	ms	500	Immediately
Pn167	Stop Time for PJOG0	100 to 10000	ms	1000	Immediately
Pn168	Turns for PJOG1	-50 to 50	rotation	-5	Immediately
Pn169	Max Speed for PJOG1	100 to 3000	rpm	1000	Immediately
Pn170	Acc./Dec. Time for PJOG1	50 to 2000	ms	500	Immediately
Pn171	Stop Time for PJOG1	100 to 10000	ms	1000	Immediately

7.5.4 Applicable Tools

- Use the Panel Operator of the Drive
- Use the ESView V4 ([Recommended](#))

7.5.5 Operation Procedure

Use the Panel Operator of the Drive

Before performing the Program Jogging (PJOG) operation by using the Panel Operator, you shall check and set the following parameters properly.



Check and set the parameters Pn164 to Pn171 as proper values in advance, and ensure the movable parts have sufficient travel in the forward and reverse directions.

For the method of checking and setting parameters by using the Panel Operator, refers to the section 4.1.4 Parameter Setting Mode.

The following are the steps to run the Motor between the two programmed operation patterns (PJOG0 and PJOG1).

Step 1 Press [M] key several times to select the Utility Function Mode.



Step 2 Press [▲] key or [▼] key to select the function number Fn018.



Step 3 Press [◀] key, and Panel Operator displays as below.



Step 4 Press [M] key to execute this operation, and Panel Operator displays as below.



Step 5 Press [◀] key to return to the display of the Fn018.

---- End

Use the ESView V4

The Motor can be run between the two programmed operation patterns (PJOG0 and PJOG1) by executing PJOG function.

Step 1 Select **Run > PJOG** in the **Menu Bar** of the *ESView V4* main windows.



Step 2 Read and follow the precautions in the warning box, and then click **OK**.

PJOG

The PJOG is to automatically calculate and generate a position planning curve based on the Pn parameter inside the servo. Used for servo debugging.

Precautions:

1. Please carry out a safety check on the mechanical running part
When the operation button is pressed, the motor will run according to the planned position curve. Please make sure that there is no danger when performing servo operation.
2. Range of motion
When the operation button is pressed, the motor will first run the specified number of turns (PJOG0) in the specified direction and then run PJOG1 until the stop button is pressed.
3. Disable forward signal (P-OT) / disable reverse signal (N-OT) to be disabled
When the program JOG is executed, the forward (P-OT) / disable reverse (N-OT) signal should be set to invalid. Even if the servo motor receives the P-OT / N-OT signal, the motor will not stop running. When performing this operation, carefully check the operating status and position of the motor.

OK

Step 3 The PJOG window will be displayed in Function Display Area.

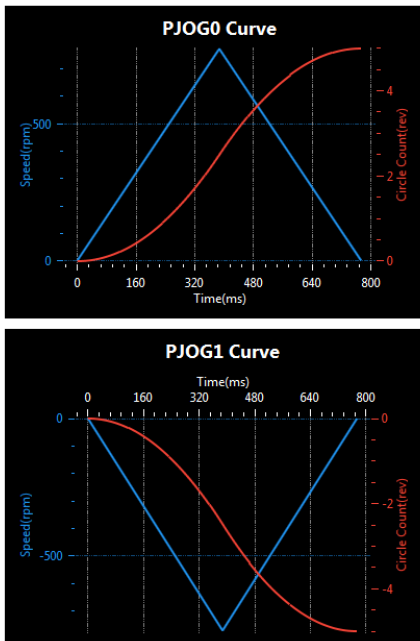

PJOG0 Curve

PJOG1 Curve

SETTINGS

PJOG0

Pn164 PJOG0 Rotation N... rev Range: -50 ~ 50

Pn165 PJOG0 Rotation S... rpm Range: 100 ~ 3000

Pn166 PJOG0 Acceleratio... ms Range: 50 ~ 2000

Pn167 PJOG0 Stop Time ms Range: 100 ~ 10000

PJOG1

Pn168 PJOG1 Rotation N... rev Range: -50 ~ 50

Pn169 PJOG1 Rotation S... rpm Range: 100 ~ 3000

Pn170 PJOG1 Acceleratio... ms Range: 50 ~ 2000

Pn171 PJOG1 Stop Time ms Range: 100 ~ 10000

Apply

OPERATIONS

Servo Off Run

Step 4 Set the relevant parameters for the operation patterns PJOG0 and PJOG1.

SETTINGS				
PJOG0				
Pn164 PJOG0 Rotation N...	<input type="text" value="5"/>	rev	Range : -50 ~ 50	
Pn165 PJOG0 Rotation S...	<input type="text" value="1000"/>	rpm	Range : 100 ~ 3000	
Pn166 PJOG0 Acceleratio...	<input type="text" value="500"/>	ms	Range : 50 ~ 2000	
Pn167 PJOG0 Stop Time	<input type="text" value="1000"/>	ms	Range : 100 ~ 10000	
PJOG1				
Pn168 PJOG1 Rotation N...	<input type="text" value="-5"/>	rev	Range : -50 ~ 50	
Pn169 PJOG1 Rotation S...	<input type="text" value="1000"/>	rpm	Range : 100 ~ 3000	
Pn170 PJOG1 Acceleratio...	<input type="text" value="500"/>	ms	Range : 50 ~ 2000	
Pn171 PJOG1 Stop Time	<input type="text" value="1000"/>	ms	Range : 100 ~ 10000	
<input type="button" value="Apply"/>				

- Rotation Number: Set the numbers of rotation the Motor will run in the operation pattern PJOG0 or PJOG1.
- NOTE: The Motor can be run in reverse when this parameter is set to a negative value.
- Rotation Speed: Set the Motor running speed in the operation pattern PJOG0 or PJOG1.
- Acceleration/Deceleration Time: Set the time it takes for the Motor runs to Rotation Speed or the Motor stops from Rotation Speed.
- Stop Time: Set the hold time when the Motor stops running in the operation pattern PJOG0 or PJOG1, and then switches to the other operation pattern.

Step 5 Click **Apply** to complete the settings.

Step 6 Click **Servo Off / Servo On** for supplying power to the Motor.

OPERATIONS	
Servo Off	<input checked="" type="checkbox"/> <input type="checkbox"/> Run

Step 7 Click **Run**.

OPERATIONS	
Servo On	<input type="checkbox"/> <input checked="" type="checkbox"/> Run

The Motor will be run between the operation patterns PJOG0 and PJOG1.

Click Stop for stopping the Motor running.

The Motor can be stopped when you close ESView V4 or PJOG window.

---- End

Chapter 8 Tuning

8.1 Overview

8.1.1 Basic Conception

Tuning is the process of satisfying the servo performance by adjusting the parameters involved in the control law.

Tuning Flow

The process of tuning is usually an iterative process, and Figure 8-1 shows the general flow.

Figure 8-1 General Tuning Process

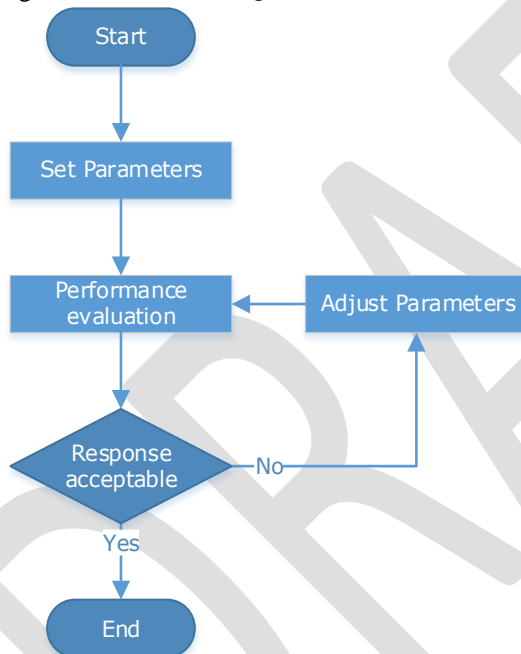

Parameter Classification

There are two types of parameters in the tuning.

- **Function Parameters:** refers to some application function selections or switches that may improve Servo performance.
- **Adjustment Parameters:** increasing or decreasing these parameters may improve Servo performance.

Servo Performance

In general, the indicators used to evaluate Servo performance are bandwidth, response time, overshoot, steady state error, anti-load disturbance, speed ripple fluctuation, torque ripple, and so on. Table 8-1 shows the comparison of the graphics before and after tuning in the example indicators.

Table 8-1 Comparison of the graphics before and after tuning

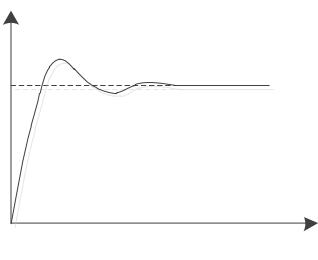
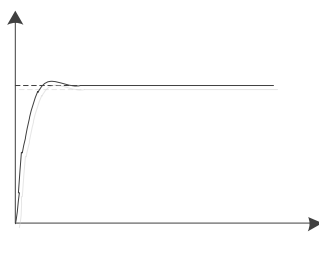
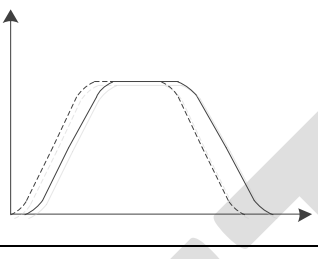
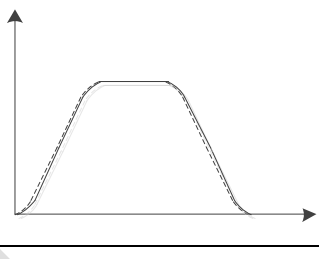
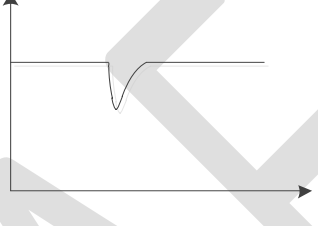
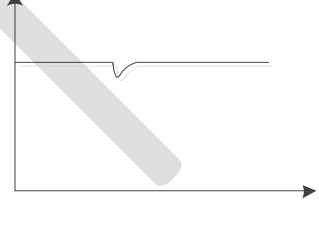
Indicator	Before tuning	After tuning
Speed step response		
Position following		
Anti-load disturbance		

8.1.2 Control Block Diagram

It is necessary to learn the Servo control principle and Figure 8-2 shows the Servo control block diagram. The position loop, the speed loop and the torque loop are cascade structures, corresponding to the position control mode, the speed control mode and the torque control mode respectively.

Figure 8-2 Servo control block diagram

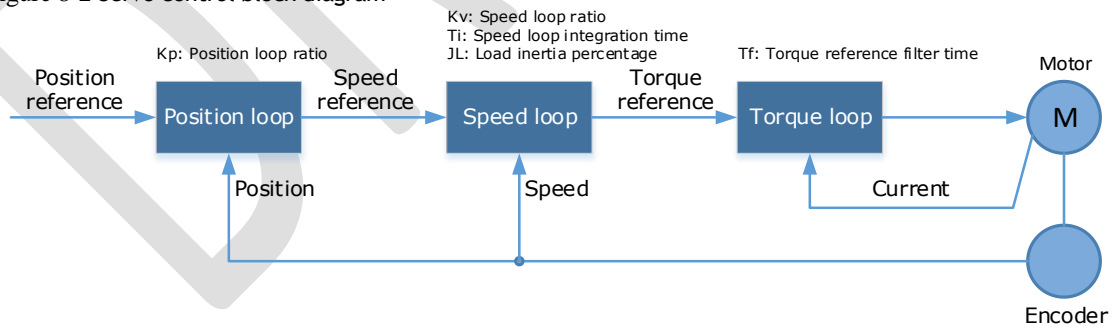

NOTE: only the basic tuning parameters during the tuning are shown in the figure.

8.1.3 Tuning Process

The Drive provides a variety of tuning methods, you can adjust the device according to the process shown in Figure 8-3, in order to obtain the desired Servo performance.

Figure 8-3 Tuning Process

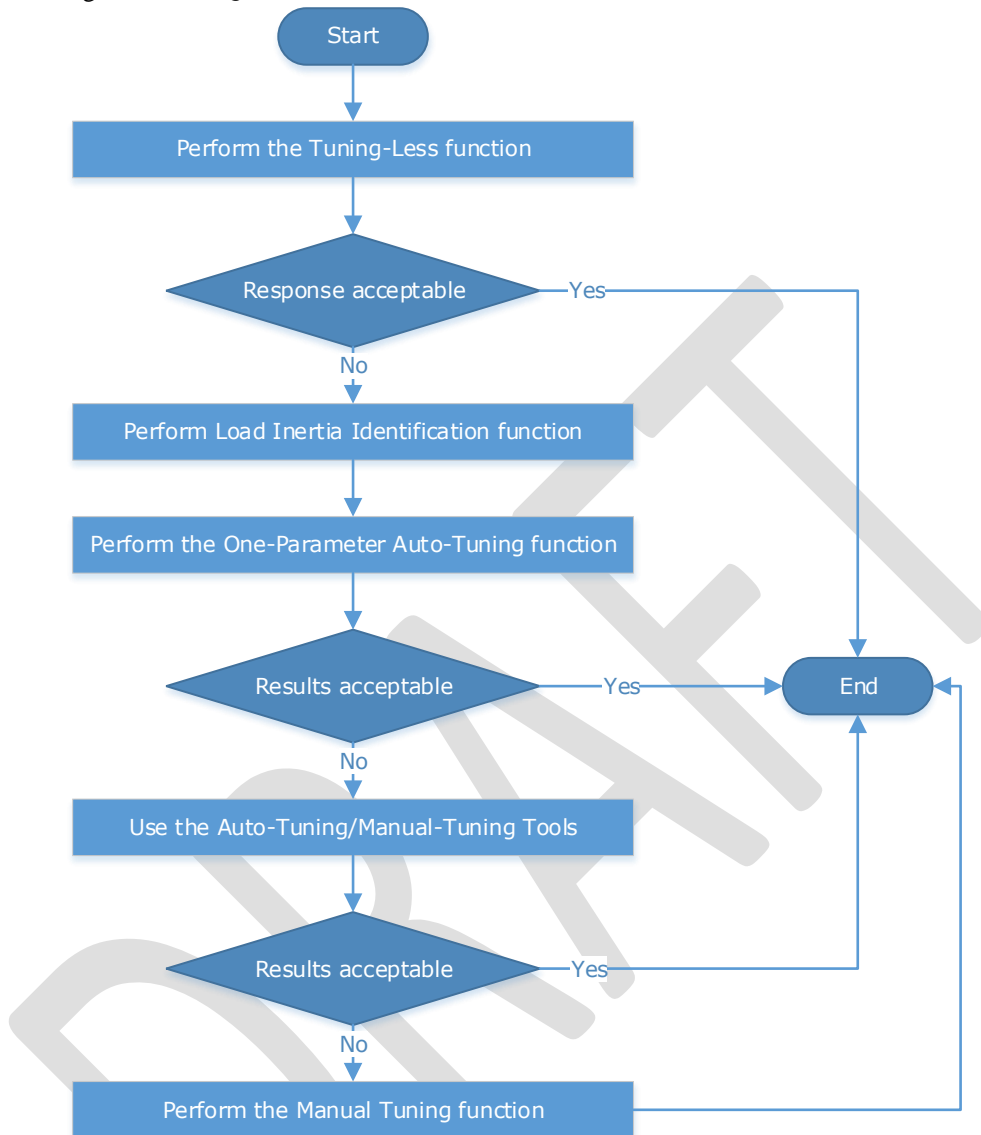
**IMPORTANT**

It is necessary to perform the tuning operation again if the Motor had been disassembled or the load device had been replaced.

8.1.4 Precautions Before Tuning



- Before performing the tuning operation, make sure the limit function is available.
- Before performing the tuning operation, make sure that an emergency stop can be performed at any time.
- Before performing the tuning operation, you shall set the torque limit according to actual condition.
- Never touch the moving parts during the tuning operation.

8.2 Tuning Modes

8.2.1 Tuning-Less

Function Description

The tuning-less performs auto-tuning to obtain a stable response regardless of the type of machine or changes in the load. Autotuning is started when the Servo is turned ON.

The tuning-less function uses an Autotune parameters adjustment module that updates the position loop and speed loop parameters in real time based on the servo operating state (position, speed, current). Figure 8-4 shows the block diagram in tuning-less.

Figure 8-4 Block diagram in tuning-less

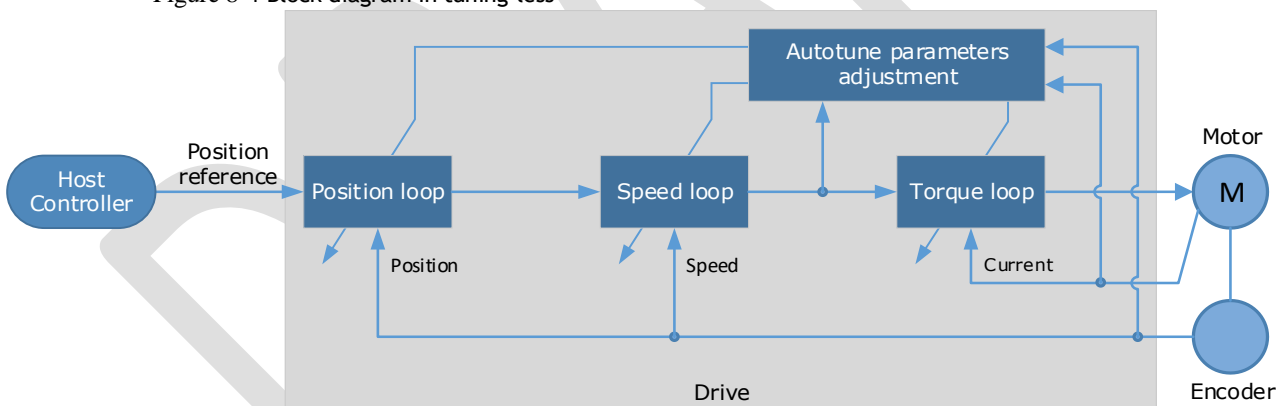

When using the tuning-less function, the following parameters are automatically adjusted.

Parameter	Adjustment method
Speed Loop Gain	Auto-tuning
Speed Loop Integral Time	Auto-tuning
Position Loop Gain	Auto-tuning
Torque Command Filter Time	Auto-tuning
Load Inertia Percentage	Auto-tuning

NOTE: The parameters will not change automatically in tuning-less function.

Applied Case

- Applied for that no more than 30 times the load moment of inertia.
- Applied for any rotation speed.

Relevant Parameters

Parameter	Setting	Meaning	When Enabled	Classification
Pn100.0	1 [Default]	Set the Tuning Mode as Tuning-less.	After restart	Function

Application Restrictions

The following functions or applications are not available in the Tuning-less function:

- Gain switch is disabled.
- P/PI Switch is disabled.
- Speed feedback by using observed speed is disabled.
- Load Torque Compensation is disabled.
- Model Following Control Function is disabled.

8.2.2 One-Parameter Auto-Tuning

Function Description

This tuning function is similar to the tuning-less function, using an Autotune parameters adjustment module that updates the position loop and speed loop parameters in real time based on the servo operating state (position, speed, current).

Only the parameter Pn101 (Servo Rigidity) needs to set in One-Parameter Auto-Tuning function, and Figure 8-5 shows the block diagram in One-Parameter Auto-Tuning.

Figure 8-5 Block diagram in One-Parameter Auto-Tuning

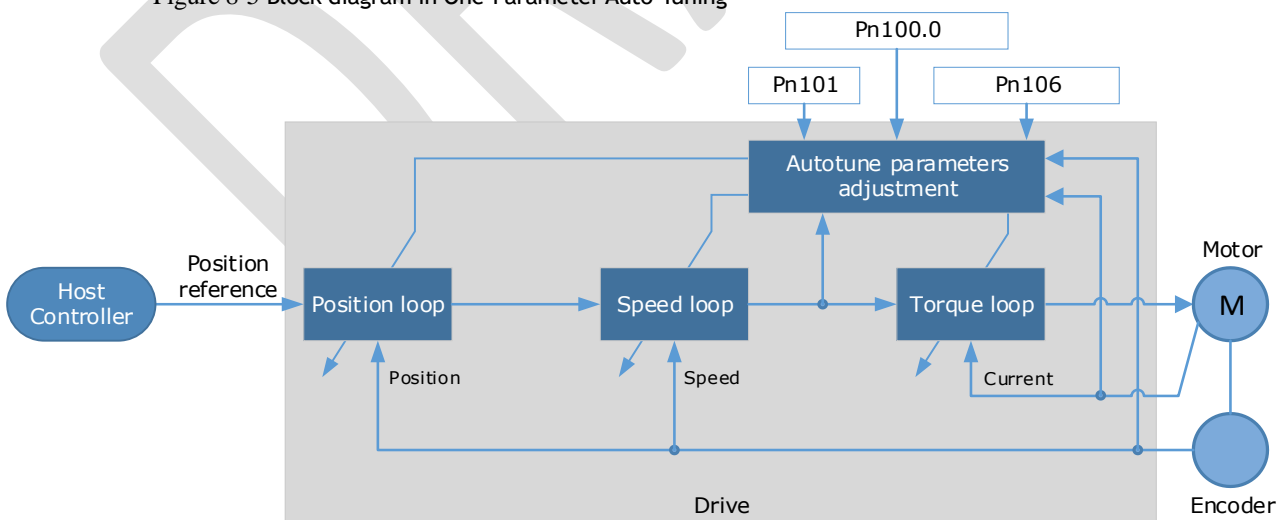

Before performing One-Parameter Auto-Tuning, you need to manually set the following parameters:

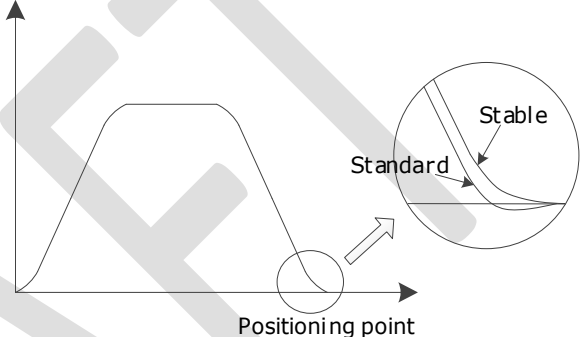
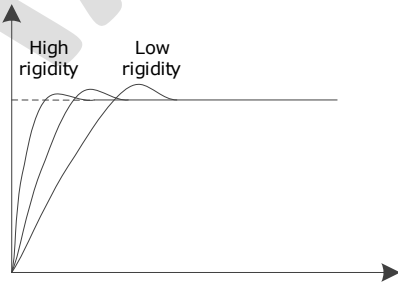
Parameter	Name	Description
Pn106	Load Inertia Percentage	<p>Properly setting the Load Inertia Percentage is a prerequisite for the One-Parameter Auto-Tuning to obtain a better Servo performance.</p> <p>You can calculate the load inertia percentage (difficult and complex) by yourself, or you can get it by the utility function Fn009 or by ESView V4, certainly, you can directly modify the parameters by the host controller.</p>
Pn100.3	Damping Selection	<p>Select a damping method according to your requirement and application.</p> <ul style="list-style-type: none"> [0] Standard: Short positioning time, but prone to overshoot. <p>Select a damping method according to your requirement and application.</p> <ul style="list-style-type: none"> [1] Stable: Stable positioning, but long positioning time. 
Pn101	Servo Rigidity	<p>The Servo Rigidity determines the response characteristic of the position loop or speed loop.</p> <p>The performance can be improved by increasing the Servo Rigidity, and decrease it if a vibration occurs.</p> <p>The figure below shows the speed step response for different Servo Rigidities:</p> 

When using One-Parameter Auto-Tuning function, the following parameters are automatically adjusted.

Parameter	Adjustment method
Speed Loop Gain	Auto-tuning
Speed Loop Integral Time	Auto-tuning
Position Loop Gain	Auto-tuning
Torque Command Filter Time	Auto-tuning

NOTE: The parameters will not change automatically in tuning-less function.

Compared to Tuning-less, there are some features below in One-Parameter Auto-Tuning:

- Tuning based on a proper load inertia percentage can get a better servo performance.
- The setting of Servo Rigidity can be applied to more operating conditions.

Applicated Case

- Applied for that more than 50 times the load moment of inertia.
- Applied for any rotation speed.

Relevant Parameters

Parameter	Setting	Meaning	When Enabled	Classification
Pn100.0	3	Set the Tuning Mode as One-Parameter Auto-Tuning .	After restart	Function
Pn100.3	0	Set the damping method in One-Parameter Auto-Tuning as Standard .		
	1	Set the damping method in One-Parameter Auto-Tuning as Stable .		
Pn101	–	Servo Rigidity	Immediately	Adjustment
Pn106	–	Load Inertia Percentage	Immediately	Adjustment

Application Restrictions

The following functions or applications are not available in One-Parameter Auto-Tuning function:

- Gain switch is disabled.
- Model Following Control Function is disabled.

8.2.3 Manual Tuning

Function Description

In the Manual Tuning, you need to manually adjust the gain parameters without using the autotune parameter adjustment module, until the Servo get the desired performance. Figure 8-6 shows the block diagram in Manual Tuning.

Figure 8-6 Block diagram in Manual Tuning

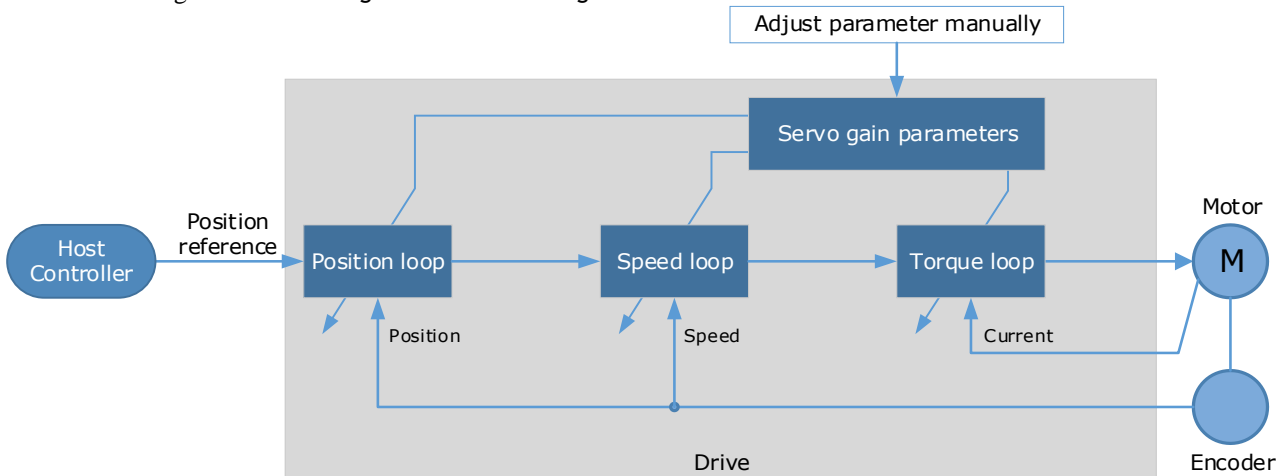

It is necessary to adjust the three-loop control parameters of the Servo from the inside out, that is, the adjustment sequence is **Torque loop** → **Speed loop** → **Position loop**. In addition, in order to meet the stability, the bandwidth setting should be the largest in the torque loop, the speed loop is the second, and the position loop is the smallest.

The following parameters need to be adjusted in each loop when performing Manual Tuning.

- Torque loop (Torque Control Mode)
 - Torque Reference Filter Time (Tf):

The torque reference filter filters the torque reference to remove the high frequency band, which can effectively reduce the torque ripple of the Motor output, eliminate signal noise and reduce the temperature rise of the Motor.

The larger the Torque Reference Filter Time, the better the filtering effect on the torque reference. However, the greater the phase lag, and the slower the torque response. Therefore, a smaller acceptable value should be set to obtain a larger torque loop bandwidth in the actual tuning.
- Speed loop (Speed Control Mode)
 - Relevant parameter in torque loop (Tf)
 - Load Inertia Percentage (JL)

Properly setting the Load Inertia Percentage is a prerequisite for the tuning to obtain a better Servo performance.

You can calculate the load inertia percentage (difficult and complex) by yourself, or you can get it by the utility function Fn009 or by ESView V4, certainly, you can directly modify the parameters by the host controller.
 - Speed Loop Gain (Kv), Speed Loop Integral Time (Ti)

The speed loop is controlled using a Proportional-Integral Controller that contains Speed Loop Gain and Speed Loop Integral Time. Both of them determine the speed loop bandwidth and anti-disturbance performance of the Servo.

In general, if you can increase the setting of the Speed Loop Gain, the speed loop bandwidth will be increased and the anti-load disturbance performance will be better. And, if you can decrease the setting of the Speed Loop Integral Time, the integral action will be stronger, the speed loop bandwidth will be increased, and the anti-load

disturbance performance will be better. In addition, the integral action may reduce the steady-state error to zero.

Table 8-2 lists several commonly used adjustment methods based on the characteristics of the speed step response.

Table 8-2 Adjustment example in speed loop

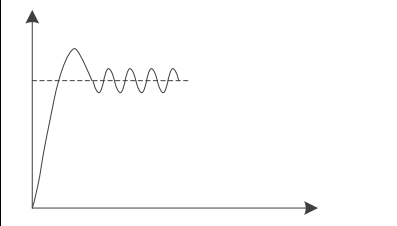
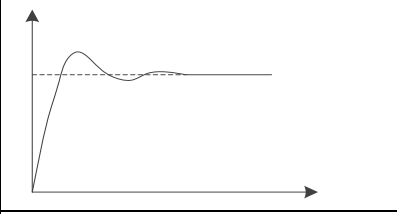
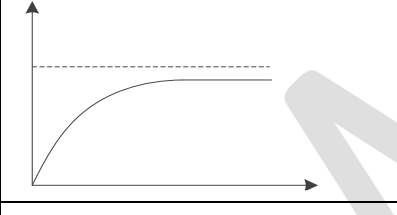
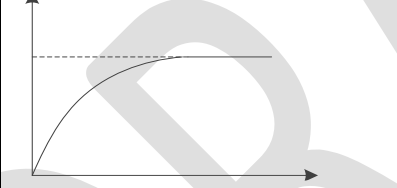
Response Curve	Description	Adjustment method
	Speed loop bandwidth is high	Properly decrease the Speed Loop Gain or increase the Speed Loop Integral Time.
	Speed loop damping ratio is low	Properly increase the Speed Loop Integral Time.
	Steady-state error is existed	Properly decrease the Speed Loop Integral Time.
	Speed loop bandwidth is low	Properly increase the Speed Loop Gain or decrease the Speed Loop Integral Time.

It is recommended to increase the Speed Loop Gain and decrease the Speed Loop Integral Time to obtain a larger speed loop bandwidth.

- Position loop (Position Control Mode)
 - Relevant parameters in speed loop (K_v , T_i , T_f , and J_L)
 - Position Loop Gain (K_p)

The position loop is controlled using a Proportional Controller that only contains the Position Loop Gain. This parameter determines the position loop bandwidth. If you increase the Position Loop Gain, the position loop bandwidth will be increased and the anti-load disturbance performance will be better. However, overshooting and vibration in the position reference may be occurred.

It is recommended to set the Position Loop Gain to a quarter of the Speed Loop Gain, and make appropriate adjustments based on this.

Applicated Case

- Applied for that more than 50 times the load moment of inertia.
- Applied for any rotation speed.

Relevant Parameters

Parameter	Setting	Meaning	When Enabled	Classification
Pn100.0	5 [Default]	Set the Tuning Mode as Manual tuning.	After restart	Function
Pn102/Pn107	–	Speed Loop Gain	Immediately	Adjustment
Pn103/Pn108	–	Speed Loop Integral Time	Immediately	Adjustment
Pn104/Pn109	–	Position Loop Gain	Immediately	Adjustment
Pn105/Pn110	–	Torque Command Filter Time	Immediately	Adjustment

NOTE: the settings of Pn107 to Pn110 are taken effect after the gain is switched.

8.3 Tuning Tools

There is an Auto-Tuning Tool and a Manual Tuning Tool in Tuning tools. When using a tuning tool, the Drive will execute the position references generated internally, Figure 8-5 shows the block diagram in using a tuning tool.

Figure 8-7 Block diagram in using a tuning tool

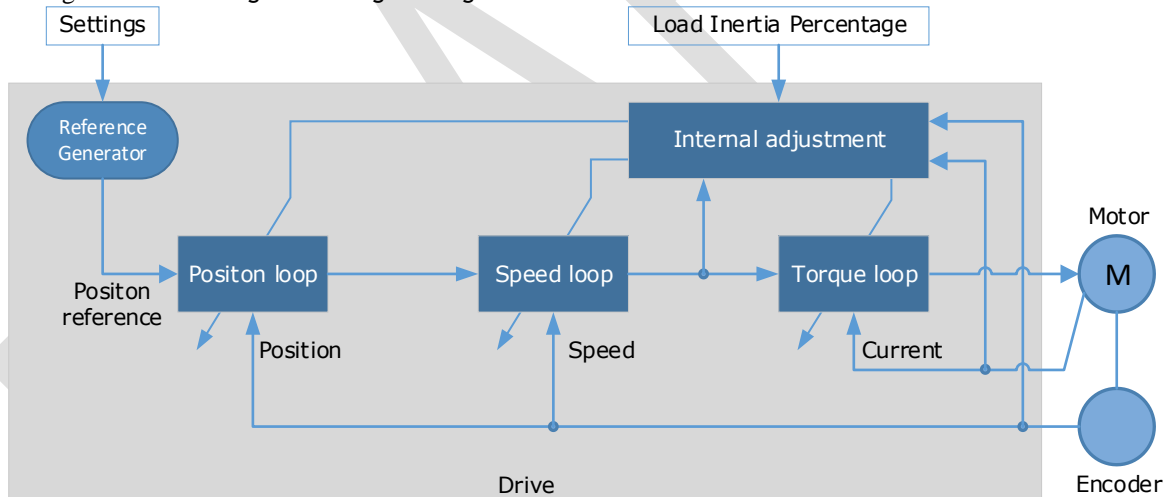

The reference generator plans an appropriate position reference according to the settings of relevant parameter.



Since the limit function is unavailable when using the tuning tools, please make sure that the movable parts have sufficient travel in the planned motion track.

8.3.2 Auto-Tuning Tool

Function Description

With the Auto-Tuning Tool, the reference generator can plan the position curve and generate a position reference as inputs to the position loop.

There are two operation patterns (POS0 and POS1), you can set their relevant parameters respectively. Figure 8-8 shows an example of position-speed timing diagram in PJOG operation.

Figure 8-8 Position-speed timing diagram

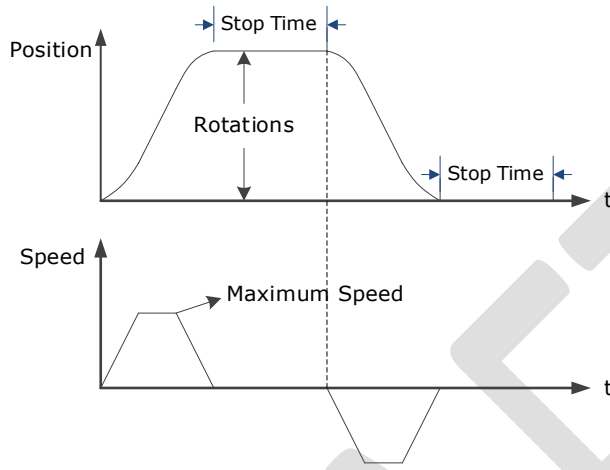

The Drive will operator the Motor repeatedly according to the parameter settings of the two operation patterns until the tuning is completed. You can set the parameters Pn164 and Pn168 to a negative value for reversing the Motor, so that there are four ways of the operation in the program jogging, as is shown in Figure 8-9.

Figure 8-9 Operation by using Auto-Tuning Tool

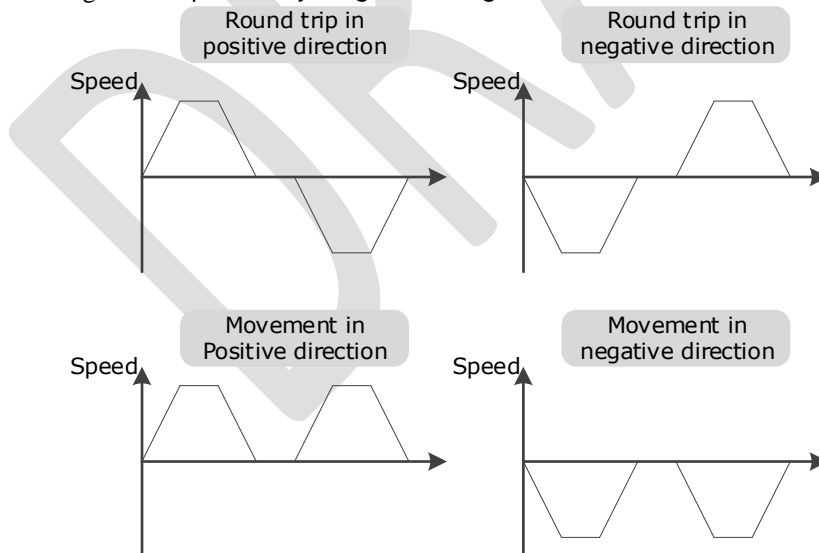

You shall set the Rotations (Pn164 and Pn168) and Max Speed (Pn165 and Pn169) to a proper value. If the Rotations is set too small or the Max Speed is set too large, it is possible that the maximum speed set cannot be reached. In this case, it is necessary to increase the Rotations or decrease the Max Speed.

Use the Auto-Tuning Tool as shown in Figure 8-10.

Figure 8-10 Auto-Tuning Tool flowchart

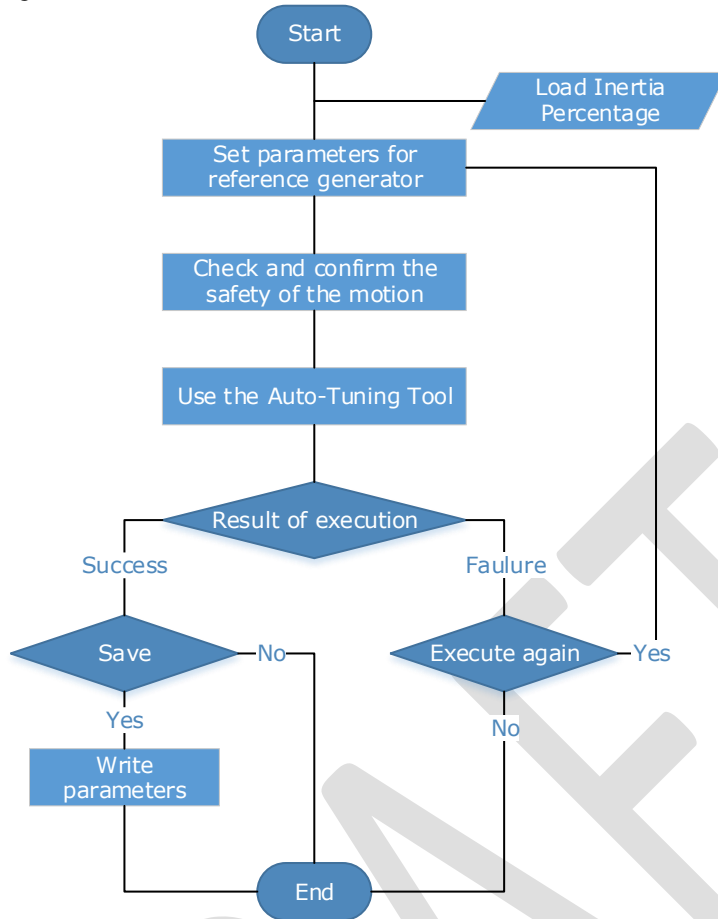

The following parameters are automatically adjusted when using the auto-tuning tool.

Parameter	Adjustment method	Write into
Speed Loop Gain	Auto-tuning	Pn102
Speed Loop Integral Time	Auto-tuning	Pn103
Position Loop Gain	Auto-tuning	Pn104
Torque Command Filter Time	Auto-tuning	Pn105



- The parameters cannot be changed automatically when using the Auto-Tuning Tool.
- You have to choose whether to save (write) the parameters into the Drive. If you choose to save, parameters will be changed, but they are only available for **Manual Tuning** function.

Applicated Case

- Applied for the high rigidity (up to 20 times load moment of inertia) equipment.
- Applied for the low rigidity (up to 10 times load moment of inertia) equipment.
- The number of revolutions is more than 1 rotation, and the rotation speed is higher than 100 rpm.

Relevant Parameters

Parameter	Setting	Description	When Enabled	Classification
Pn106	–	Load Inertia Percentage	Immediately	Adjustment
Pn164	–	Turns for PJOG0	Immediately	Adjustment
Pn165	–	Max Speed for PJOG0	Immediately	Adjustment
Pn167	–	Stop Time for PJOG0	Immediately	Adjustment
Pn168	–	Turns for PJOG1	Immediately	Adjustment
Pn169	–	Max Speed for PJOG1	Immediately	Adjustment
Pn171	–	Stop Time for PJOG1	Immediately	Adjustment

Application Restrictions

You can use the automatic vibration suppression function when using the auto-tuning tool.

The following functions or applications are not available when using Auto-Tuning Tool:

- Gain switch is disabled.
- Model Following Control Function is disabled.
- Notch Filter is disabled.
- Vibration Suppression is disabled.
- Load Oscillation Suppression is disabled.



The Auto-Tuning Tool is unavailable in fully-closed loop control.

Operation Procedure: Use the Panel Operator of the Drive

The following are the steps to use the Auto-tuning tool.

Step 1 Press [M] key several times to select the Utility Function Mode.

Step 2 Press [▲] key or [▼] key to select the function number Fn017.

Step 3 Press [◀] key, and Panel Operator displays as below.

Lit for that the adaptive notch filter is enabled

Step 4 Press [M] key to execute this operation, and Panel Operator display as below.

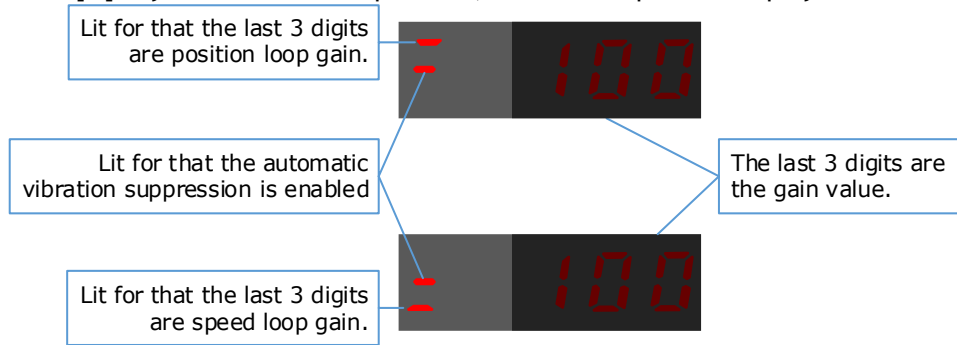

Step 5 When this operation has been completed, Panel Operator will display the result of execution.



Step 6 Press [◀] key to return to the display of the Fn017.

---- End

Operation Procedure: Use the ESView V4

By using the Auto-Tuning Tool, the Drive can automatically perform the round-trip (forward and reverse) operation to adjust for machine characteristics.

Step 1 Select **Tuning** → **Tuning Tools** → **Auto-Tuning Tool** in the **Menu Bar** of the *ESView V4* main windows.

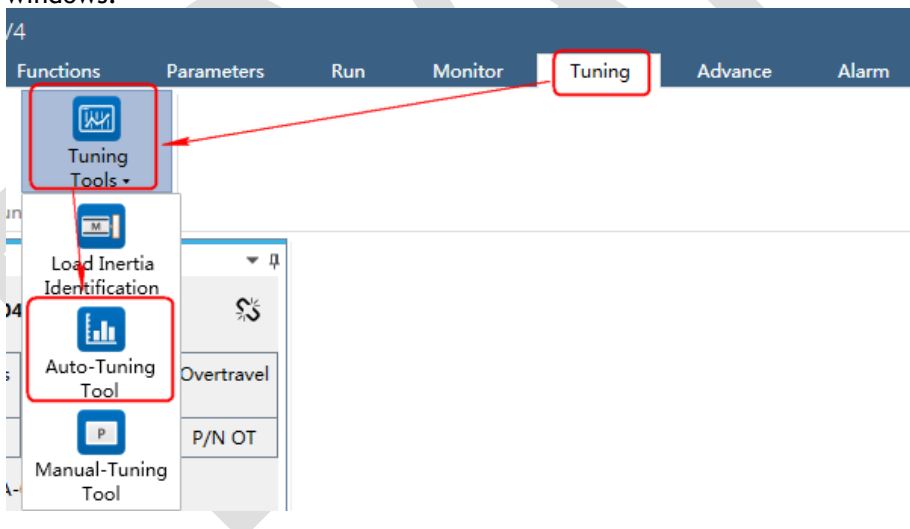

Step 2 Read and follow the precautions in the warning box, and then click **OK**.

Parameter Auto-Tuning Tool

Parameter Auto-Tuning refers to the internal position command given by the servo, and the gain parameter is automatically adjusted during the running process to achieve better performance of the servo system. This function is not available for torque control mode.

Precautions:

1. Please carry out a safety check on the mechanical running part
When the operation button is pressed, the motor will run according to the planned position curve. Please make sure that there is no danger when performing servo operation.
2. Range of motion
When the operation button is pressed, the motor will run the specified number of turns (POS0) in the specified direction and then run POS1, and continue running until the end of the tuning process or press the stop button.
3. Disable forward signal (P-OT) / disable reverse signal (N-OT) to be disabled
When the program JOG is executed, the forward-forward (P-OT)/inhibit-reverse (N-OT) signal should be set to be invalid. Even if the servo motor receives the P-OT/N-OT signal, the motor will not stop running. When performing this operation, carefully check the operating status and position of the motor.
4. Emergency stop operation
In an emergency, you can stop the motor by pressing the stop button.

OK

Step 3 The Auto-Tuning Tool window will be displayed in Function Display Area.

Step 4 Click **Detect** to perform **Load Inertia Identification** function if necessary.

LOAD INERTIA

Detect

SETTINGS

POS0

Pn164 PJOG0 Rotation N... rev Range: -50 ~ 50

Pn165 PJOG0 Rotation S... rpm Range: 100 ~ 3000

Pn167 PJOG0 Stop Time ms Range: 100 ~ 10000

POS1

Pn168 PJOG1 Rotation N... rev Range: -50 ~ 50

Pn169 PJOG1 Rotation S... rpm Range: 100 ~ 3000

Pn171 PJOG1 Stop Time ms Range: 100 ~ 10000

Apply



Step 5 Set the relevant parameters for the operation patterns POS0 and POS1.

SETTINGS

POS0

Pn164 PJOG0 Rotation N... rev Range: -50 ~ 50

Pn165 PJOG0 Rotation S... rpm Range: 100 ~ 3000

Pn167 PJOG0 Stop Time ms Range: 100 ~ 10000

POS1

Pn168 PJOG1 Rotation N... rev Range: -50 ~ 50

Pn169 PJOG1 Rotation S... rpm Range: 100 ~ 3000

Pn171 PJOG1 Stop Time ms Range: 100 ~ 10000

Apply

- **Rotation Number:** Set the numbers of rotation the Motor will run in the operation pattern POS0 or POS1.
- **Rotation Speed:** Set the Motor running speed in the operation pattern POS0 or POS1.

- **Stop Time:** Set the hold time when the Motor stops running in the operation pattern POS0 or POS1, and then switches to the other operation pattern.

Step 6 Click **Apply** to complete the settings.

Step 7 Click **Running Tuning**.

The screenshot shows the 'Parameter Settings' window. The 'LOAD INERTIA' section is at the top with a 'Detect' button. Below it, the 'Running Tuning' section is highlighted with a red box. The 'SETTINGS' section is divided into 'POS0' and 'POS1'.

Parameter	Value	Unit	Range
Pn164 PJOG0 Rotation N...	5	rev	Range : -50 ~ 50
Pn165 PJOG0 Rotation S...	1000	rpm	Range : 100 ~ 3000
Pn167 PJOG0 Stop Time	1000	ms	Range : 100 ~ 10000
POS1			
Pn168 PJOG1 Rotation N...	-5	rev	Range : -50 ~ 50
Pn169 PJOG1 Rotation S...	1000	rpm	Range : 100 ~ 3000
Pn171 PJOG1 Stop Time	1000	ms	Range : 100 ~ 10000

An 'Apply' button is located at the bottom right of the settings section.

Step 8 The window will display the preparations before running the tuning.

The screenshot shows the 'Parameter Settings' window. The 'RUN' section is at the top, with a checked 'Online Vibration Suppression' checkbox. Below it, the 'Servo Off' button is highlighted with a red box. The 'Running Tuning' section is below that, showing various loop and filter settings.

Setting	Value/Status
Speed Loop	[Slider]
Position Loop	[Slider]
Notch Filter	[Radio Button]
Vibration Suppression Filter	[Radio Button]

The setting will be written into the Drive automatically after you check or uncheck **Online Vibration Suppression** option.

Step 9 Click **Servo Off** / **Servo On** for supplying power to the Motor.

The screenshot shows the 'Parameter Settings' window. The 'RUN' section is at the top, with a checked 'Online Vibration Suppression' checkbox. Below it, the 'Servo Off' button is highlighted with a red box. The 'Running Tuning' section is below that, showing various loop and filter settings.

Setting	Value/Status
Speed Loop	[Slider]
Position Loop	[Slider]
Notch Filter	[Radio Button]
Vibration Suppression Filter	[Radio Button]

Step 10 Click Run.

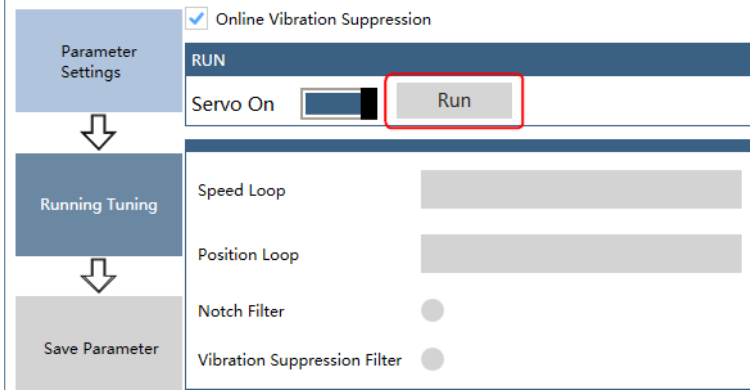

Step 11 The Motor will be run between the operation patterns POS0 and POS1.

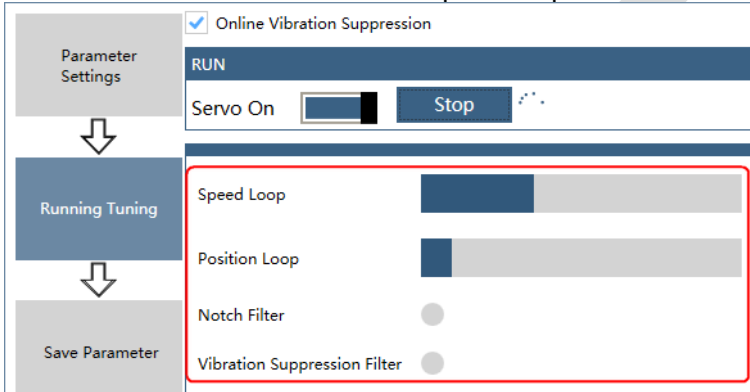

Step 12 Click OK when the Auto-Tuning Tool function has been completed.

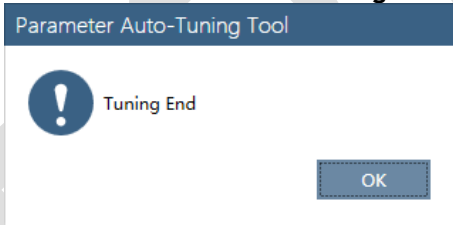

Step 13 Click Save Parameter.

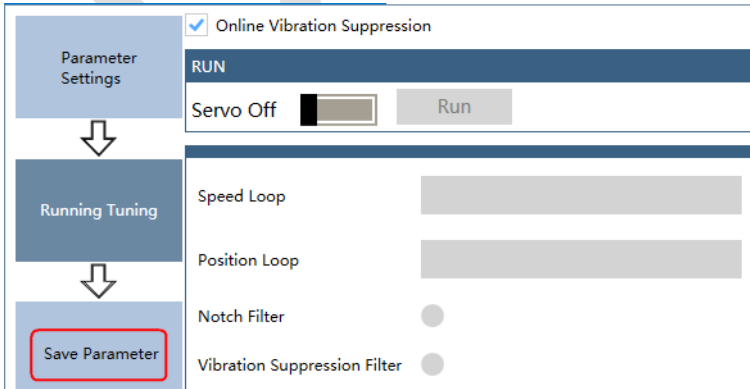

Step 14 Check the **RESULT**, and click **Save**, the settings of parameters will be written into the Drive automatically.

	RESULT	Current Value	Setting Value	Unit
Parameter Settings				
↓				
Running Tuning				
↓				
Save Parameter				
	Pn102 Speed Loop Gain	500	1658	rad/s
	Pn103 Speed Loop Integral Time	125	37	0.1ms
	Pn104 Position Loop Gain	40	255	1/s
	Pn105 Torque Reference Filter Time Constant	50	10	0.01ms
	Pn173 Vibration Suppression Frequency at Intermediate-Frequency	2000	2000	Hz
	Pn181 Notch Filter Frequency 1	5000	5000	Hz
	Pn184 Notch Filter Frequency 2	5000	5000	Hz
	Pn187 Notch Filter Frequency 3	5000	5000	Hz

Save

---- End

DRAFT

8.3.3 Manual-Tuning Tool

By using the Manual-Tuning Tool, you will set the Servo gain parameters again and again according to the waveform graphics of the data (Speed Feedback, Speed Setting, Position Feedback and Position Setting), as far as the performance of the servo meets the requirements.

Step 1 Select **Tuning** → **Tuning Tools** → **Manual-Tuning Tool** in the **Menu Bar** of the **ESView V4** main windows.

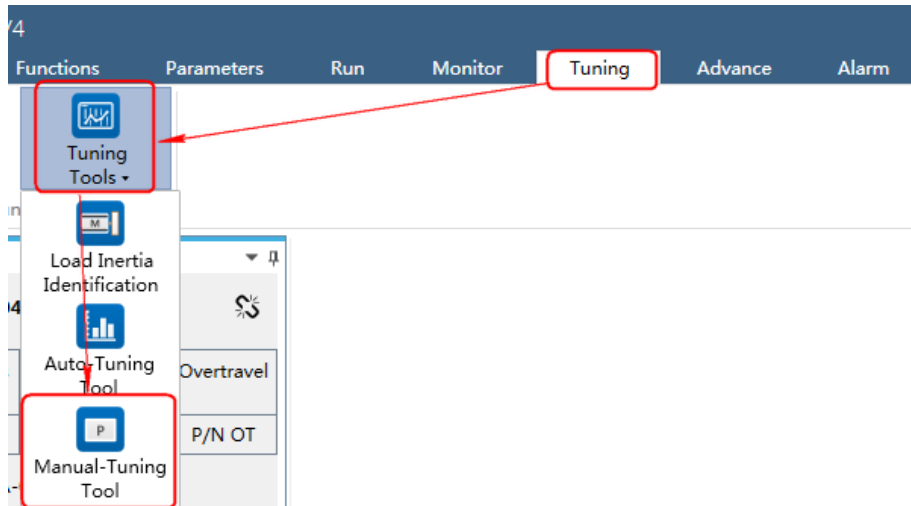

Step 2 The **Manual-Tuning Tool** window will be displayed in **Function Display Area**.

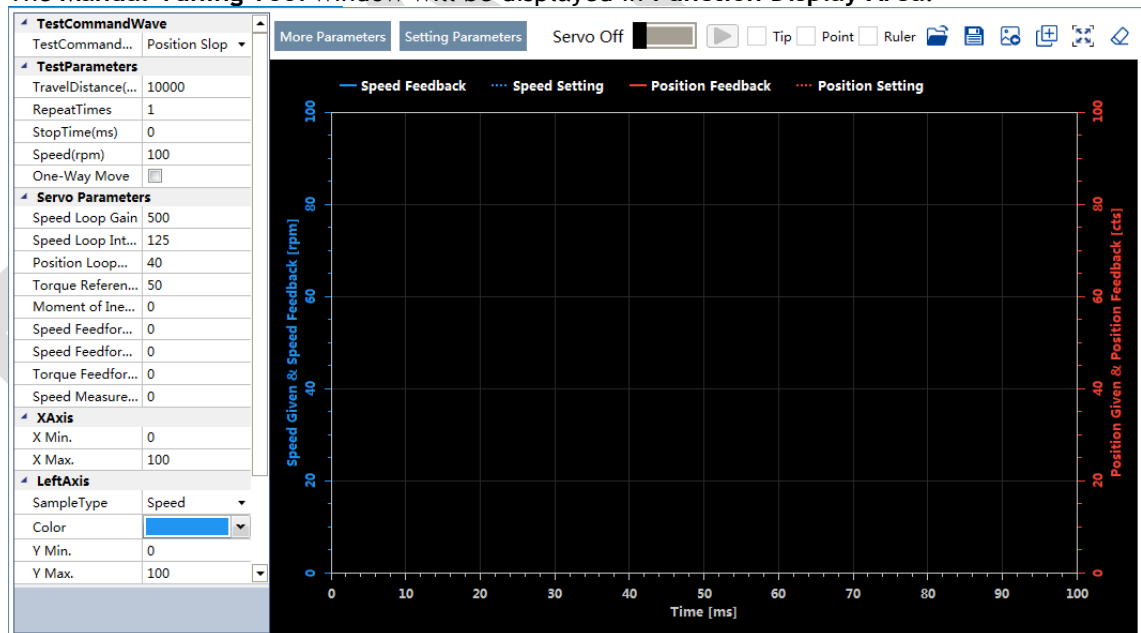

Step 3 Set the necessary parameters of the **Test Command**.

- Choose **Test Command Wave** as **Position Slope**, the Drive will operate in position control method, and the trajectory of the Motor in Two-way movement and One-way movement is

shown in the figure below. (Set Repeat Times as 2)

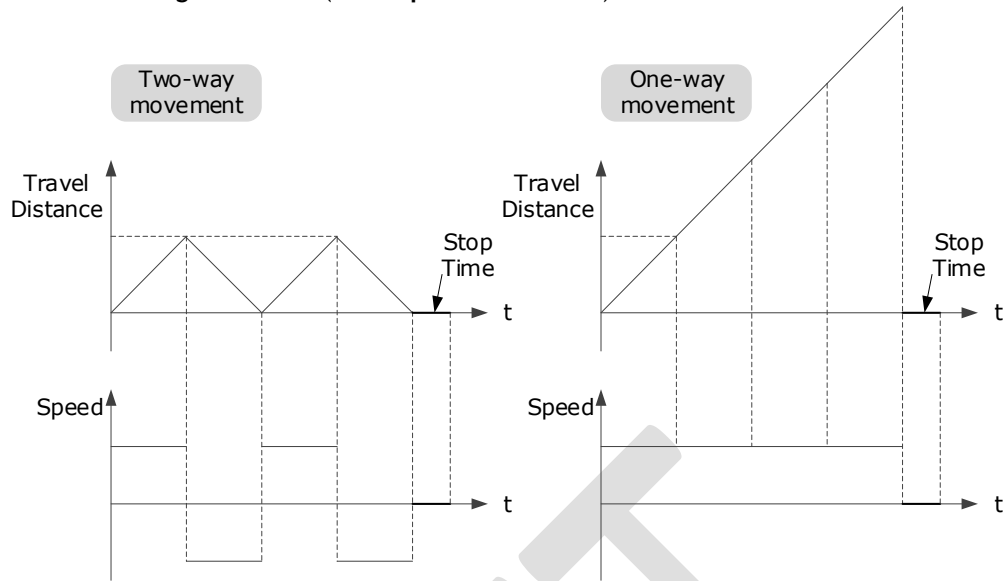

The relevant parameters in the **Position Slope** are shown in the table below.

Parameter	Range	Description
Travel Distance	-9 999 999 to 9 999 999	The travel distances the Motor moves in one command. The positive and negative values indicate the direction of rotation.
Repeat Times	1 to 10	The number of times the command was executed.
Stop Time	0 to 32767	Set the hold time when the Motor stops running.
Frequency	1 to 50	The number of cycles the command completes in 1 second.
One-Way Move	-	Check this option indicates that the Motor is running in One-way movement.

- **Sinusoidal of position**

When "Test instruction waveform" is set to "position sine", the driver will run in position control mode, and the position instruction generated internally makes the motor move in non-unidirectional motion and the track of unidirectional motion as shown in Figure 8-14 ("Repetition times" is set to 2).

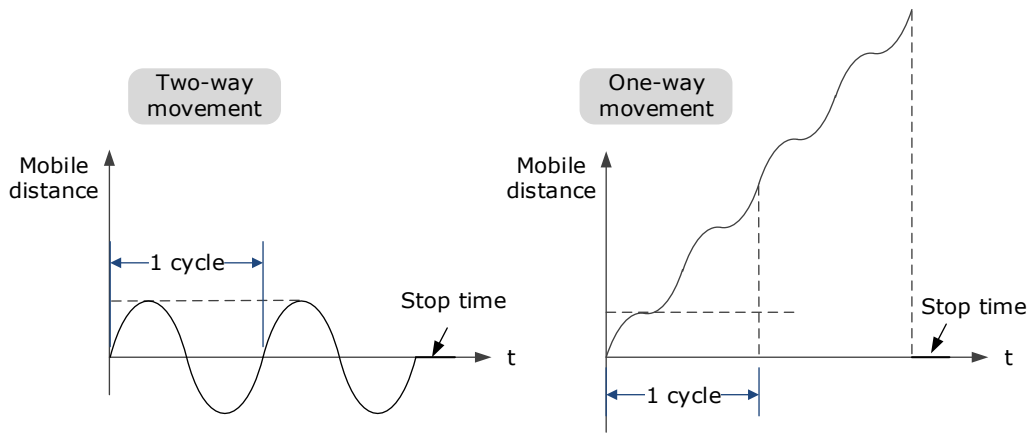

The relevant parameters in the **Position Stepwise** are shown in the table below.

Parameter	Range	Description
Travel Distance	-9 999 999 to 9 999 999	The travel distances the Motor moves in one command. The positive and negative values indicate the direction of rotation.
Repeat Times	1 to 10	The number of times the command was executed.
Stop Time	0 to 32767	Set the hold time when the Motor stops running.
Stepwise Time	1 to 32767	The time to execute one command.
One-Way Move	-	Check this option indicates that the Motor is running in One-way movement.

• **Queue a position steps**

When "Test instruction waveform" is set to "position step", the driver will run in position control mode, and the position instructions internally generated make the motor move in non-unidirectional and unidirectional time sequence as shown in Figure 8-15 (assuming "repetition times" is set to 2).

位置阶跃指令

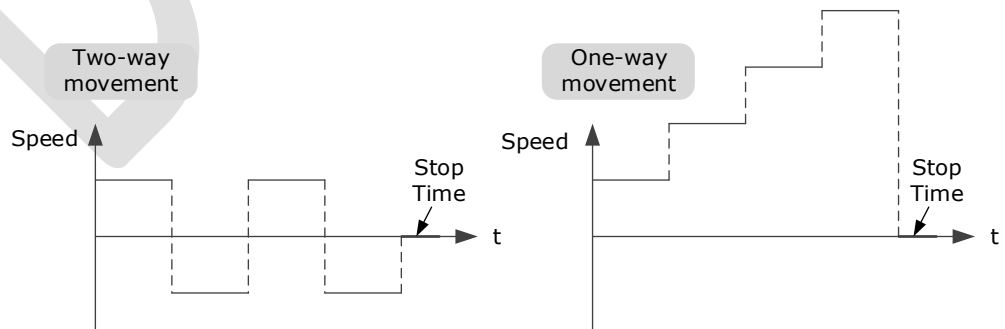

Parameter	Range	Description
Travel Distance	-9 999 999~9 999 999	The travel distances the Motor moves in one command. The positive and negative values indicate the direction of rotation.

Parameter	Range	Description
Repeat Times	1~10	The number of times the command was executed.
Stop Time	0~32767	Set the hold time when the Motor stops running.
Speed	1~32767	The speed of the Motor when the command is executed.
Acceleration	-	The travel distances the Motor moves in one command. The positive and negative values indicate the direction of rotation.

- **Linear velocity trapezoid**

When "Test Instruction Waveform" is set to "speed trapezoid", the driver will run in position control mode, and the position instruction generated internally makes the motor in non-unidirectional motion and unidirectional motion speed waveform as shown in Figure 8-15 ("Repetition times" is set to 2).

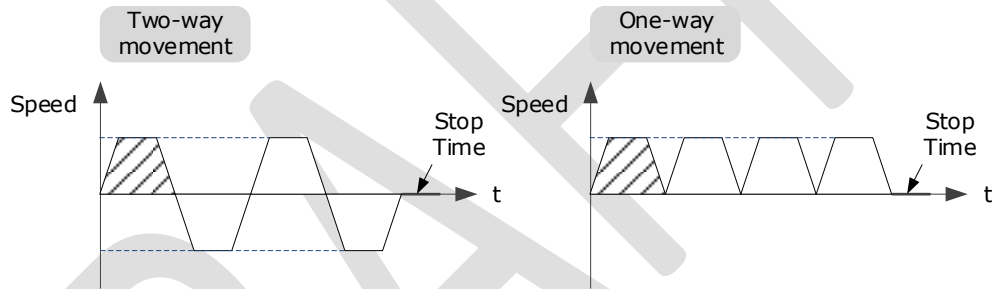

Anyway, you risk losing your set speed by setting the "travel distance" too small.

The relevant parameters in the Speed Trapezoid are shown in the table below.

Parameter	Range	Description
Travel Distance	-9 999 999 to 9 999 999	The travel distances the Motor moves in one command. The positive and negative values indicate the direction of rotation.
Repeat Times	1 to 10	The number of times the command was executed.
Stop Time	0 to 32767	Set the hold time when the Motor stops running.
Speed	0 to 3000	The speed of the Motor when the command is executed.
Acceleration	1 to 65535	The Acceleration of the Motor when the command is executed.
One-Way Move	-	Check this option indicates that the Motor is running in One-way movement.

Step 4 Set the necessary parameters for the data collected.

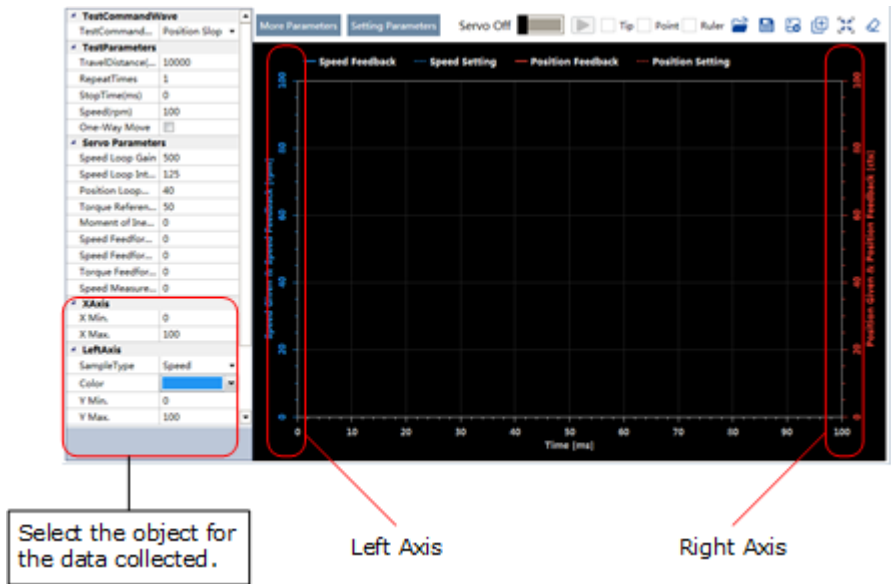

- X Axis: Indicates Times.
- Left Axis: Select **Sample Type** as **Speed** or **Position**. This selection will affect the **Sample Type** of the Right Axis.
- Right Axis: Select **Sample Type** as **None**, **Speed**, **Position**, or **Offset**. The setting **Offset** indicates the deviation of the sample type (speed or position) selected by the left axis.

Step 5 Set the necessary parameters for the Servo gain.

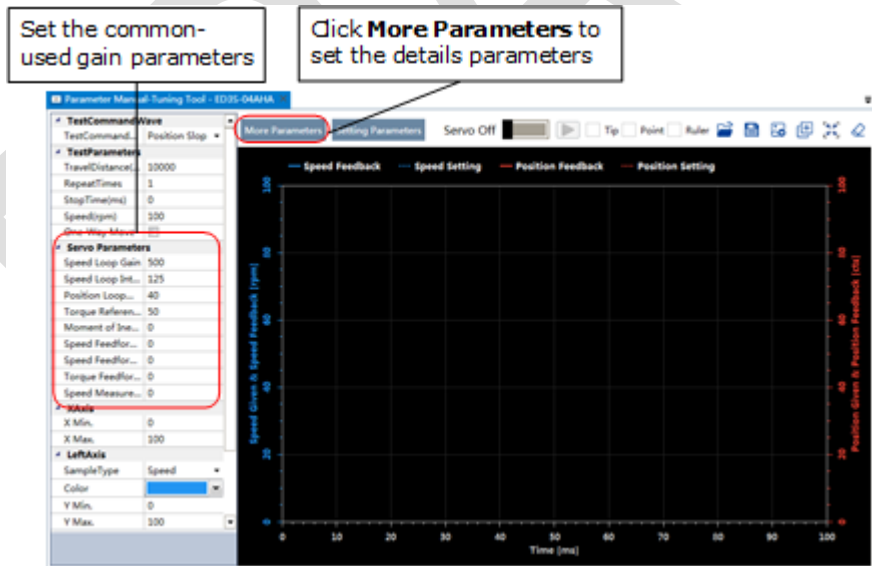

The parameters that may be used are shown in Table 8-3.

Table 8-3 The parameters that may be used

Type	Parameter	Name	Range	Unit	Default	When Enabled
Gain	Pn102	Speed Loop Gain	1 to 10000	rad/s	500	Immediately
	Pn103	Speed Loop Integral Time	1 to 5000	0.1ms	125	Immediately
	Pn104	Position Loop Gain	0 to 1000	1/s	40	Immediately
	Pn105	Torque Command Filter Time	0 to 2500	0.01ms	50	Immediately
	Pn106	Load Inertia Percentage	0 to 9999	%	0	Immediately
	Pn107	Second Speed Loop Gain	1 to 10000	rad/s	250	Immediately
	Pn108	Second Speed Loop Integral Time	1 to 5000	0.1ms	200	Immediately
	Pn109	Second Position Loop Gain	0 to 1000	1/s	40	Immediately
	Pn110	Second Torque Reference Filter Time	0 to 2500	0.01ms	100	Immediately
	Pn116	P/PI Switch Mode	0 to 4	–	0	After restart
	Pn117	Torque Reference Threshold for P/PI Switch	0 to 300	200	%	Immediately
	Pn118	Deviation Counter Threshold for P/PI Switch	0 to 10000	0	1 pulse	Immediately
	Pn119	Acceleration Reference Threshold for P/PI Switch	0 to 3000	0	10 rpm/s	Immediately
	Pn120	Speed Reference Threshold for P/PI Switch	0 to 10000	rpm	0	Immediately
	Pn121	Gain Switch Mode	0 to 10	–	0	After restart
Pn122	Delay Time for Gain Switch	0 to 20000	0.1 ms	0	Immediately	
Pn123	Threshold for Gain Switch	0 to 20000	–	0	Immediately	

Type	Parameter	Name	Range	Unit	Default	When Enabled
	Pn124	Speed Threshold for Gain Switch	0 to 2000	rpm	0	Immediately
	Pn125	Ramp Time for Position Loop Gain Switch	0 to 20000	0.1ms	0	Immediately
	Pn126	Hysteresis for Gain Switch	0 to 20000	–	0	Immediately
Feedforward and Vibration Suppression	Pn005	Application Function Selections 5	00d0 to 33d3	–	00d0	After restart
	Pn005.0	Internal Torque Feedforward Method	0 to 3	–	0	
	Pn005.1	Local Control Method	d to d	–	d	
	Pn005.2	Torque Feedforward Method	0 to 3	–	0	
	Pn005.3	Speed Feedforward Method	0 to 3	–	0	
	Pn112	Speed Feedforward	0 to 100	%	0	Immediately
	Pn113	Speed Feedforward Filter Time	0 to 640	0.1ms	0	Immediately
	Pn114	Torque Feedforward	0 to 100	%	0	Immediately
	Pn115	Torque Feedforward Filter Time	0 to 640	0.1ms	0	Immediately
	Pn150	Model Following Control Function	0000 to 0002	–	0000	After restart
	Pn150.0	Model Following Control Selection	0 to 2	–	0	
	Pn151	Model Following Control Gain	10 to 1000	1/s	50	Immediately
	Pn152	Model Following Control Gain Correction	20 to 500	%	100	Immediately
	Pn153	Model Following Control Speed Feedforward	0 to 200	%	100	Immediately

Type	Parameter	Name	Range	Unit	Default	When Enabled
	Pn154	Model Following Control Torque Feedforward	0 to 200	%	100	Immediately
	Pn155	Load Oscillation Frequency	50 to 500	0.1Hz	100	Immediately
	Pn156	Filter Time for Load Oscillation Suppression	2 to 500	0.1ms	10	Immediately
	Pn157	Limit for Load Oscillation Suppression	0 to 1000	rpm	100	Immediately
	Pn173	Frequency of Vibration Suppression Filter	100 to 2000	Hz	2000	Immediately
	Pn174	Adjust Bandwidth of Vibration Suppression Filter	1 to 100	–	30	Immediately
	Pn175	Vibration Suppression	0 to 500	–	100	Immediately
	Pn176	Lowpass Filter Time for Vibration Suppression	0 to 50	0.1ms	0	Immediately
	Pn177	Highpass Filter Time for Vibration Suppression	0 to 1000	0.1ms	1000	Immediately
	Pn178	Damping of Vibration Suppression Filter	0 to 500	–	100	Immediately
	Pn181	Frequency of Notch Filter 1	50 to 5000	Hz	5000	Immediately
	Pn182	Depth of Notch Filter 1	0 to 23	–	0	Immediately
	Pn183	Width of Notch Filter 1	0 to 15	–	2	Immediately
	Pn184	Frequency of Notch Filter 2	50 to 5000	Hz	5000	Immediately
	Pn185	Depth of Notch Filter 2	0 to 23	–	0	Immediately
	Pn186	Width of Notch Filter 2	0 to 15	–	2	Immediately

Type	Parameter	Name	Range	Unit	Default	When Enabled
	Pn187	Frequency of Notch Filter 3	50 to 5000	Hz	5000	Immediately
	Pn188	Depth of Notch Filter 3	0 to 23	–	0	Immediately
	Pn189	Width of Notch Filter 3	0 to 15	–	2	Immediately
Others	Pn127	Low Speed Filter	0 to 100	1cycle	0	Immediately
	Pn130	Coulomb Friction Compensation	0 to 3000	0.1%Tn	0	Immediately
	Pn131	Speed Dead Band for Coulomb Friction Compensation	0 to 100	rpm	0	Immediately
	Pn132	Viscous Friction Compensation	0 to 1000	0.1%Tn/1000rpm	0	Immediately
	Pn135	Encoder Speed Filter Time	0 to 30000	0.01ms	4	Immediately
	Pn160	Load Torque Compensation	0 to 100	%	0	Immediately
	Pn161	Load Torque Observer Gain	0 to 1000	Hz	200	Immediately
	Pn162	Feedback Speed Selection	0 to 1	–	0	After restart

Step 6 Click **Servo Off / Servo On** for supplying power to the Motor.

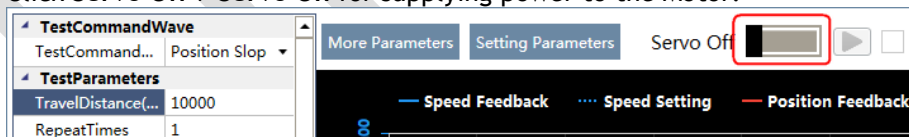

Step 7 Click  to start using Manual-Tuning Tool.

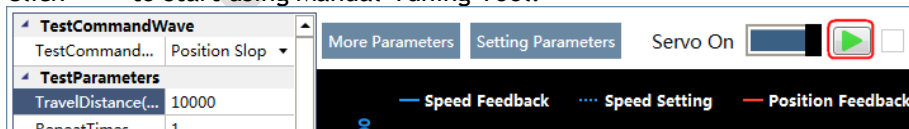

The Motor will run according to the set parameters and perform the data collecting.

Step 8 When the **Manual-Tuning Tool** function has been completed, the waveform graphics of the data result is displayed in the window.

The figure below is an example of data collecting results with the **Position Slope** command.

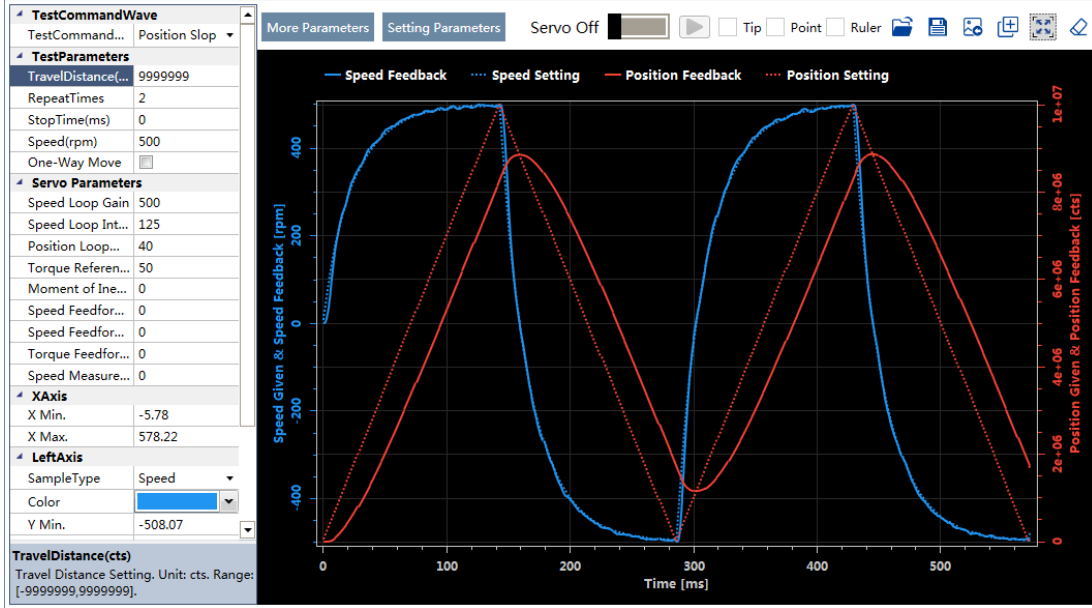

Step 9 Repeat setting the parameters and perform the data collecting until result meets the requirements.

Step 10 Click **Setting Parameters** after confirming that the results have reached the desired performance, and the parameters will be written into the Drive.

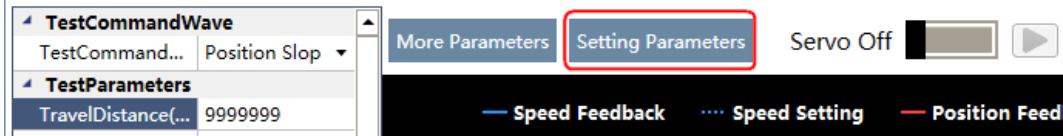

----End

8.4 Feedback Speed Selection

The speed feedback from the encoder is the calculate result that the Drive read the position value from the encoder and differentiate time.

There is a speed observer inside the Drive for detecting the speed of the Motor in real time. The detected speed can be used for host controller monitoring or as a speed feedback for the speed loop.

In the case of low speed or low encoder resolution, the method of position-to-time differentiation introduces large noise. You can set Pn162=1 to use observed speed as the feedback speed.

In addition, you can increase the setting of Pn161 for making the observed speed closer to the actual speed, but overshooting will be likely to occur.

Parameter	Setting	Meaning	When Enabled	Classification
Pn161	–	Load Torque Observer Gain	Immediately	Adjustment
Pn162	0 [Default]	Use encoder speed as the feedback speed.	After restart	Function
	1	Use observed speed as the feedback speed.		

If you keep the default setting of Pn162, you can use a low-pass filter to eliminate the noise and high-frequency band, in this case, you shall set Encoder Speed Filter Time (Pn135) as a proper value.

Increase the setting of Pn135, the filtering effect will be better, and the encoder feedback speed will be smooth, but the phase lag of the speed feedback is also larger, which can reduce the servo performance.

Parameter	Setting	Meaning	When Enabled	Classification
Pn135	–	Encoder Speed Filter Time	Immediately	Adjustment

8.5 Additional Adjustment Functions

8.5.1 Gain Switching

Function Description

The gain switching function can be used for the manual tuning. It is required to switch from 1st gain parameters to 2nd gain parameters for the Servo operation in a specific stage, so that the overall performance of the Servo system can reach the desired performance.

Take Figure 8-11 as an example, the position stage focuses on the performances such as position ripples and positional rigidity, while the moving stage focuses on the performance such as following error. In this case, two switchable groups of gain parameters are required to meet the Servo performance.

Figure 8-11 Gain switching example

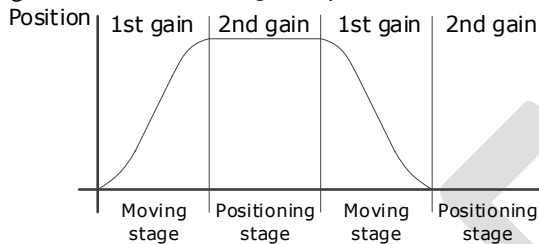

The parameters of the first gain and the second gain are as follows.

Parameter	First Gain	Second Gain
Speed Loop Gain	Pn102	Pn107
Speed Loop Integral Time	Pn103	Pn108
Position Loop Gain	Pn104	Pn109
Torque Command Filter Time	Pn105	Pn110

The gain switching function includes two settings: one is the conditions for starting the gain switching and the other is which process to start the gain switching. Figure 8-1213 shows a timing diagram for the gain switching.

Figure 8-12 Gain switching timing diagram

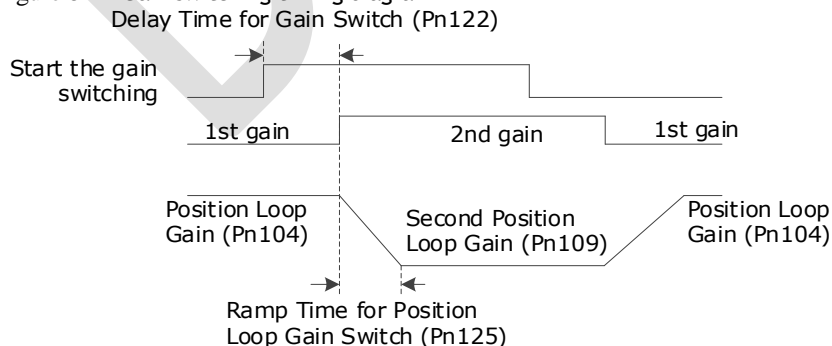

Conditions for the Gain Switching

The Drive uses the first group of gain parameters by default. You can set the parameter Pn121 (Gain Switch Mode) as a desired value, so that the second group of gain parameters are used when the condition set in Pn121 are met.

Parameter	Setting	Meaning	When Enabled	Classification
Pn121	0 [Default]	Fixed to first group gains.	After restart	Function
	1	Use external signal (G-SEL) as the condition.		
	2	Use torque reference as the condition (threshold setting: Pn117).		
	3	Use position deviation counter as the condition (threshold setting: Pn118).		
	4	Use acceleration as the condition (threshold setting: Pn119).		
	5	Use speed reference as the condition (threshold setting: Pn120).		
	6	Use position reference as the condition (threshold setting: Pn123).		
	7	Use actual speed as the condition (threshold setting: Pn124).		
	8	Use position reference (Pn123) and actual speed (Pn124) as the condition.		
	9	Fixed to second group gains.		
	10	Use positioning completed flag as the condition.		

- Set Pn121 to 0 (Fixed to first group gains), indicating that the first group of gain parameters is always used.
- Set Pn121 to 1 (Use external signal (G-SEL) as the condition) or 10 (Use positioning completed flag as the condition), indicating that switch to second group of gain parameters when the G-SEL signal is active or positioning completed, otherwise the first group of gain parameters is used.
- Set Pn121 as 2 to 7, indicating that switch to second group of gain parameters when the switching condition exceeds the set threshold value, otherwise the first group of gain parameters is used.

In this case, you can set a proper Hysteresis for Gain Switch (Pn126) to avoid the error between input and output, and Figure 8-13 shows the diagram for this setting.

Figure 8-13 Hysteresis for Gain Switch diagram

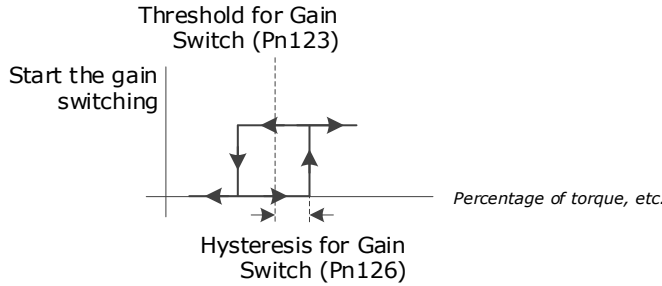

- Set Pn121 to 8 (Use position reference and actual speed as the condition), indicating that there are two conditions to be met when switching to the second gain:
 - Condition 1: Hysteresis switching based on position reference, you shall set a proper Threshold value for Gain Switch (Pn123) and Hysteresis for Gain Switch (Pn126). This condition is met when the output exceeds the sum of Pn123 and Pn126.
 - Condition 2: Switch based on actual speed judgment, and you shall set a proper Speed Threshold for Gain Switch (Pn124). This condition is met when the actual speed exceeds the threshold value.

Both condition 1 and condition 2 are met, switching to second group of gain parameters, otherwise the first group of gain parameters is used.
- Set Pn121 to 9 (Fixed to second group gains), indicating that the second group of gain parameters is always used.

Relevant Parameters

Parameter	Setting	Meaning	When Enabled	Classification
Pn122	–	Delay Time for Gain Switch	Immediately	Adjustment
Pn123	–	Threshold for Gain Switch	Immediately	Adjustment
Pn124	–	Speed Threshold for Gain Switch	Immediately	Adjustment
Pn125	–	Ramp Time for Position Loop Gain Switch	Immediately	Adjustment
Pn126	–	Hysteresis for Gain Switch	Immediately	Adjustment

8.5.2 P/PI Switching

The Drive uses the Proportional-Integral Controller by default to adjust the speed loop. You can set Pn116 (P/PI Switch Mode) for switching to the Proportional Controller when the set condition is met.

Parameter	Setting	Meaning	When Enabled	Classification
Pn116	0 [Default]	Use torque reference as the condition (threshold setting: Pn117).	After restart	Function
	1	Use position deviation counter as the condition (threshold setting: Pn118).		
	2	Use acceleration reference as the condition (threshold setting: Pn119)		

Parameter	Setting	Meaning	When Enabled	Classification
	3	Use the speed reference as the condition (threshold setting: Pn120).		
	4	Fixed to PI Control.		

- Set Pn116 to 4 (Fixed to PI Control), indicating that the Proportional-Integral Controller is always used.
- Set Pn116 as 0 to 3, indicating that switch to Proportional Controller when the switching condition exceeds the set threshold value, otherwise the Proportional-Integral Controller is used.

The relevant threshold parameters are shown in the table below.

Parameter	Setting	Meaning	When Enabled	Classification
Pn117	–	Torque Reference Threshold for P/PI Switch	Immediately	Adjustment
Pn118	–	Deviation Counter Threshold for P/PI Switch	Immediately	Adjustment
Pn119	–	Acceleration Reference Threshold for P/PI Switch	Immediately	Adjustment
Pn120	–	Speed Reference Threshold for P/PI Switch	Immediately	Adjustment

Take the default settings as an example, the default setting of Pn116 is 0 (Use torque reference as the condition), and the default Torque Reference Threshold for P/PI Switch (Pn117) is 200, in this case, when the torque reference percentage exceeds 200, the speed loop adjustment will be switched from PI control to P control, and then if the torque reference percentage is not more than 200, the speed loop adjustment is switched to PI control.

8.5.3 Feedforward

Feedforward includes speed feedforward and torque feedforward.

- Speed feedforward can improve position response and reduce position following error
- Torque feedforward can improve the speed response and reduce the speed following error

Figure 8-1415 shows the block diagram in the feedforward function.

Figure 8-14 Feedforward block diagram

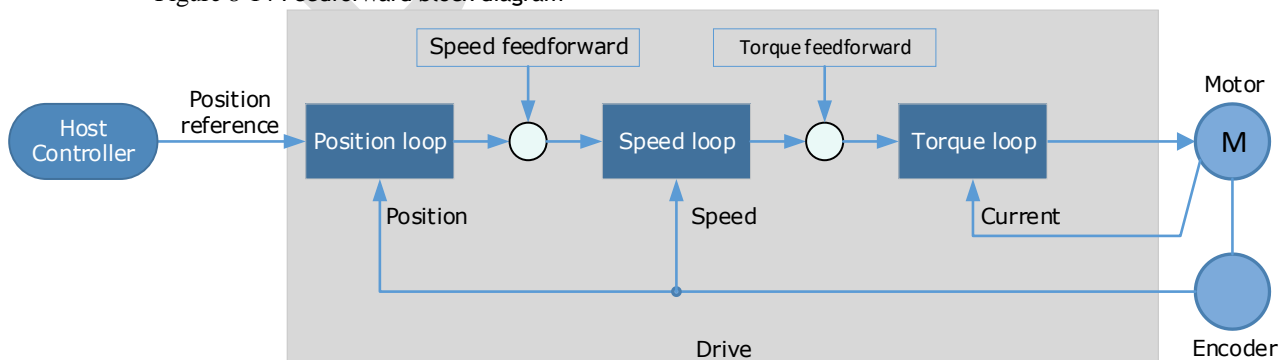

In general, the differential of the position reference is used as the feedforward, you can also set the feed forward by the controller or other application functions.

You can set Pn005 to select the method for the feedforward.

Parameter	Setting	Meaning	When Enabled	Classification		
Pn005.3	0 [Default]	Use the internal speed feedforward.	After restart	Function		
	1	Use the model following control speed feedforward, which is available when Model Following Control Selection (Pn150.0) is enabled.				
	2	Use the speed feedforward set by the controller, which is available in the bus control and set by the object 60B1h.				
	3	Use the speed feedforward generated by Cubic interpolation algorithm, which is available when the object 60C0h is set to Cubic interpolation algorithm in bus control.				
Pn005.2	0 [Default]	Use the internal torque feedforward.			After restart	Function
	1	Use the model following control torque feedforward, which is available when Model Following Control Selection (Pn150.0) is enabled.				
	2	Use the torque feedforward set by the controller, which is available in the bus control and set by the object 60B2h.				
	3	Use the torque feedforward generated by Cubic interpolation algorithm, which is available when the object 60C0h is set to Cubic interpolation algorithm in bus control.				

Internal Feedforward

In order to reduce the overshoot caused by the feedforward when the setting of Pn005.3 or Pn005.2 is 0, it is necessary to set Speed Feedforward (Pn112) or Torque Feedforward (Pn114) to adjust the feedforward compensation value.

- Internal Speed Feedforward = Differential of position reference × Speed Feedforward
- Internal Torque Feedforward = Differential of speed reference × Load Inertia Percentage × Torque Feedforward

In addition, it is required to filter the noise caused by the differential for the feedforward. You can increase the Filter Time for the feedforward, the noise can be filtered better, but overshooting may be occurred.

In the case of high rotation speed, you shall set Pn005.0 to 2 and Pn005.2=0.

Parameter	Setting	Meaning	When Enabled	Classification
Pn005.0	0	Use the general internal torque feedforward.	After restart	Function
	2	Use the high-speed internal torque feedforward.		
Pn112	–	Speed Feedforward	Immediately	Adjustment
Pn113	–	Speed Feedforward Filter Time	Immediately	Adjustment
Pn114	–	Torque Feedforward	Immediately	Adjustment
Pn115	–	Torque Feedforward Filter Time	Immediately	Adjustment

Model Following Control Feedforward

You shall confirm and set that the Model Following Control function has been enabled (Pn150.0=1 or 2), and then set Pn005.3=1 (Use the model following control speed) or Pn005.2=1 (Use the model following control torque feedforward).

Feedforward Set by Controller

The setting of Pn005.3=2 (Use the speed feedforward set by the controller) or Pn005.2=2 (Use the torque feedforward set by the controller) is only available for EtherCAT Communication.

The relevant objects are 60B1h and 60B2h.

Index	Subindex	Name	Data Type	Access	PDO Mapping	Value
60B1h	0	Velocity Offset	INT32	RW	Yes	-2147483648 to 2147483647
60B2h	0	Torque Offset	INT16	RW	Yes	-32768 to 32767

Feedforward calculated by Cubic Interpolation

The setting of Pn005.3=3 (Use the speed feedforward generated by Cubic interpolation algorithm) or Pn005.2=3 (Use the torque feedforward generated by Cubic interpolation algorithm) is only available for EtherCAT Communication.

The relevant object is 60C0h.

Index	Subindex	Name	Data Type	Access	PDO Mapping	Value
60C0h	0	Interpolation sub mode select	INT16	RW	No	-1

8.5.4 Friction Compensation

The load friction must exist in the transmission system. However, severe load friction may cause low-speed crawling, waveform distortion at speed zero-crossing, positioning lag, etc., which can affect the dynamic and static performance of the Servo system.

The friction compensation function is that the Drive compensates the load friction by using the relevant parameter settings, which can be used for applications with frequently forward and reverse motion, and high speed-stability requirements.

Friction compensation is used to compensate for viscous friction fluctuations and coulomb friction fluctuations.

You can set Coulomb Friction Compensation (Pn130) manually, and its direction is consistent with the direction of rotation speed. In addition, it is necessary to set Speed Dead Band for Coulomb Friction Compensation (Pn131) to avoid the Motor changing the compensation direction frequently near zero speed, in this case, the Friction Compensation in the Dead Band is 0, as is shown in Figure 8-15.

Figure 8-15 Friction compensation diagram

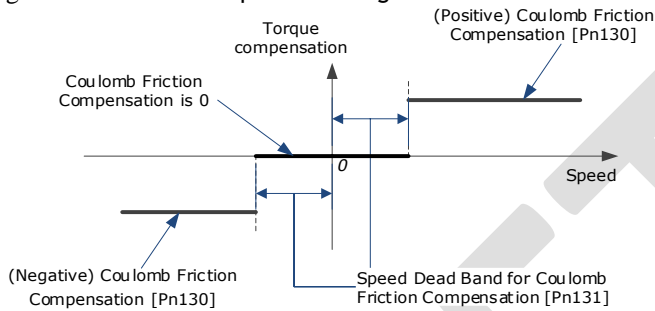

The viscous friction compensation is a linear relationship with the Motor speed, as is shown in Figure 8-16. You can set the Viscous Friction Compensation by Pn132.

Figure 8-16 Relationship between viscous friction and speed

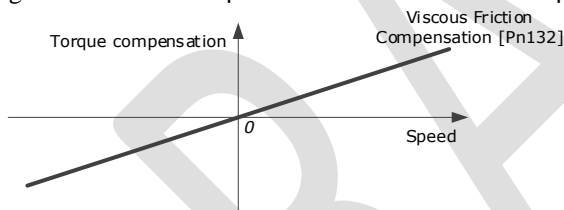

Parameter	Setting	Meaning	When Enabled	Classification
Pn130	-	Coulomb Friction Compensation	Immediately	Adjustment
Pn131	-	Speed Dead Band for Coulomb Friction Compensation	Immediately	Adjustment
Pn132	-	Viscous Friction Compensation	Immediately	Adjustment

8.5.5 Load Torque Compensation

If there is a sudden load torque during the operation of the Motor, the speed will decrease or the position will move. The continuously changing load torque will also cause the speed fluctuation or position jitter. In this case, it is generally necessary to improve the anti-load disturbance performance of the servo by tuning.

In the tuning process, the load torque compensation function can be used to improve the anti-load disturbance performance, considering that the reference response performance and the load disturbance resistance cannot be balanced.

As shown in the figure below, the speed drop is caused by a sudden load torque, and the load torque compensation function can be used to reduce the drop of the speed.

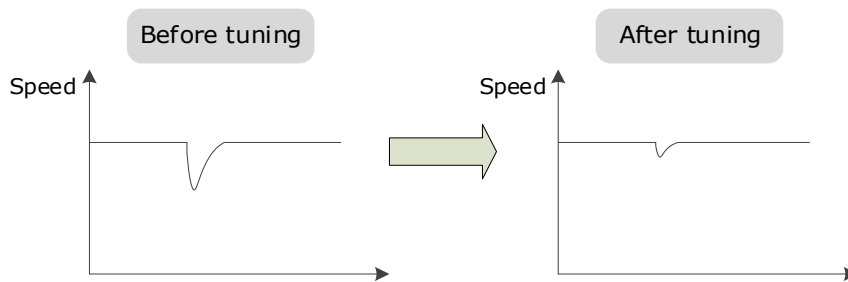

The load torque compensation function is to compensate the load torque compensation to the torque reference through the load torque observer.

To reduce the overshoot caused by load torque compensation, use the load disturbance compensation percentage to adjust the compensation value:

Load Torque Compensation = Load Torque Observer × Load Inertia Percentage (Pn160)

In addition, you can adjust the bandwidth of the load torque observer via Load Torque Observer Gain (Pn161). Increase the setting of Pn161 for making the observed torque closer to the actual torque, but overshooting will be likely to occur.

Parameter	Setting	Meaning	When Enabled	Classification
Pn160	-	Load Torque Compensation	Immediately	Adjustment
Pn161	-	Load Torque Observer Gain	Immediately	Adjustment

8.5.6 Model Following Control

The Model Following Control is outside of the position loop. In Model Following Control, new position references are generated based on the theoretical Motor control model, and relevant speed feedforward and torque feedforward are generated. Applying these controls to the actual control loop can significantly improve the response performance and positioning performance of the position control. Figure 8-17 shows the block diagram in model following control.

Figure 8-17 Block diagram in model following control

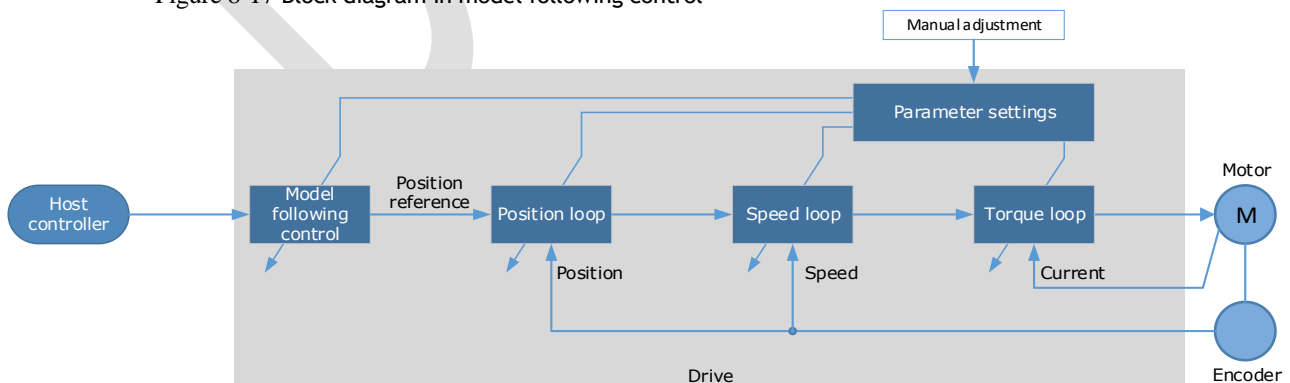

To use the Model Following Control function, set the following parameter.

Parameter	Setting	Meaning	When Enabled	Classification
Pn150.0	0 [Default]	Do not use Model Following Control.	After restart	Function
	1	Use the model following control.		
	2	Use the model following control and load oscillation suppression.		

To use the Model Following Control properly, you shall adjust the relevant parameters in the order of **Torque Loop** → **Speed Loop** → **Position Loop** → **Model Following Control**.

For details on the relevant parameter of Torque Loop, Speed Loop and Position Loop, refers to the section 8.2.3 Manual Tuning. The relevant parameters of Model Following Control are as follows.

Parameter	Setting	Meaning	When Enabled	Classification
Pn151	–	Model Following Control Gain	Immediately	Adjustment
Pn152	–	Model Following Control Gain Correction	Immediately	Adjustment

The Model Following Control Gain (Pn151) determines the position response performance, and increase this setting can improve speed of response, but overshooting will be likely to occur.

The Model Following Control Gain Correction (Pn152) determines the damping ratio, and increase this setting can also increase the damping ratio.

The (speed/torque) feedforward in Model Following Control is a percentage factor that is used to adjust the output feedforward.

Parameter	Setting	Meaning	When Enabled	Classification
Pn153	–	Model Following Control Speed Feedforward	Immediately	Adjustment
Pn154	–	Model Following Control Torque Feedforward	Immediately	Adjustment

NOTE: only when Pn005.3=1 or Pn005.2=1, the settings of above parameter are available.

The following application restrictions apply to the Mode Following Control.

- Only applied for the Manual Tuning.
- Only applied for the Position Control Modes.
- It is unavailable in fully-closed loop control.

8.6 Vibration Suppression

8.6.1 Notch Filter

The notch filter is used to eliminate vibration caused by mechanical resonance.

There are three notch filters in the Drive, those who can used independently or in combination, Figure 8-18 shows the block diagram of using the notch filters.

Figure 8-18 Block diagram of using the notch filters

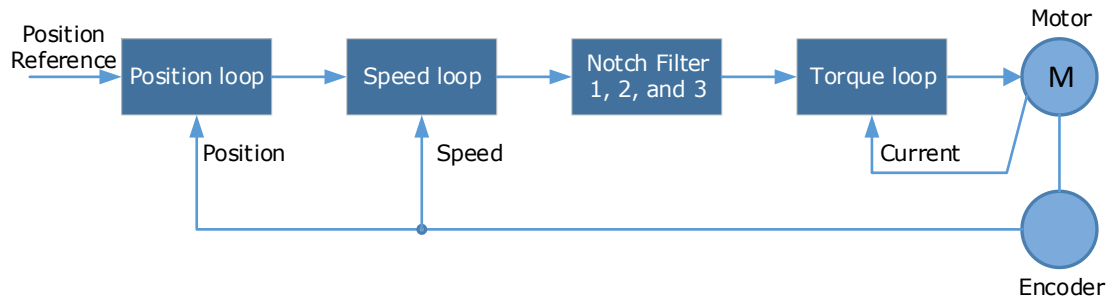
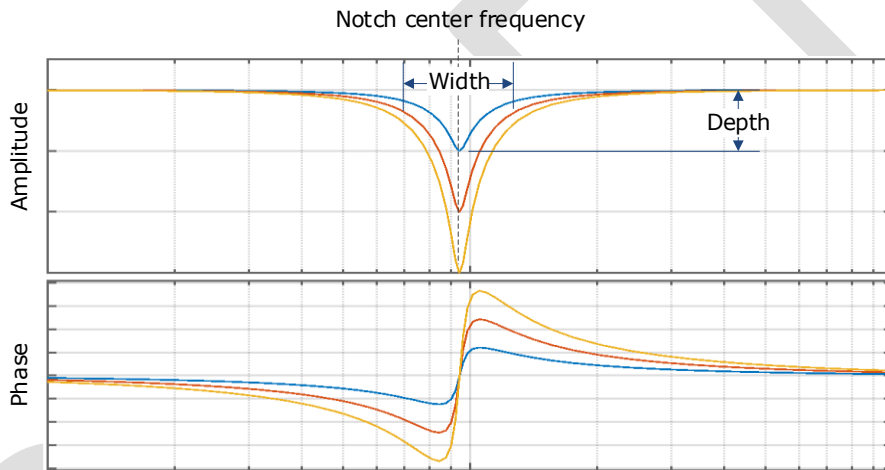

Figure 8-19 shows the relevant parameters for the notch filter. Since the notch filter can attenuate the signal at the notch frequency, if you set a proper frequency (Pn181, Pn184 or Pn187), depth (n182, Pn185 or Pn188) and width (n183, Pn186 or Pn189), the vibration signal in the torque reference can be filtered.

Figure 8-19 Diagram of notch filter parameters



Parameter	Setting	Meaning	When Enabled	Classification
Pn181	–	Frequency of Notch Filter 1	Immediately	Adjustment
Pn182	–	Depth of Notch Filter 1	Immediately	Adjustment
Pn183	–	Width of Notch Filter 1	Immediately	Adjustment
Pn184	–	Frequency of Notch Filter 2	Immediately	Adjustment
Pn185	–	Depth of Notch Filter 2	Immediately	Adjustment
Pn186	–	Width of Notch Filter 2	Immediately	Adjustment
Pn187	–	Frequency of Notch Filter 3	Immediately	Adjustment
Pn188	–	Depth of Notch Filter 3	Immediately	Adjustment
Pn189	–	Width of Notch Filter 3	Immediately	Adjustment

- Set the frequency of notch filter to 5000, indicating the notch filter is unavailable.
- The setting range of the depth is from 0 to 23.
- The setting range of the width is from 0 to 15.

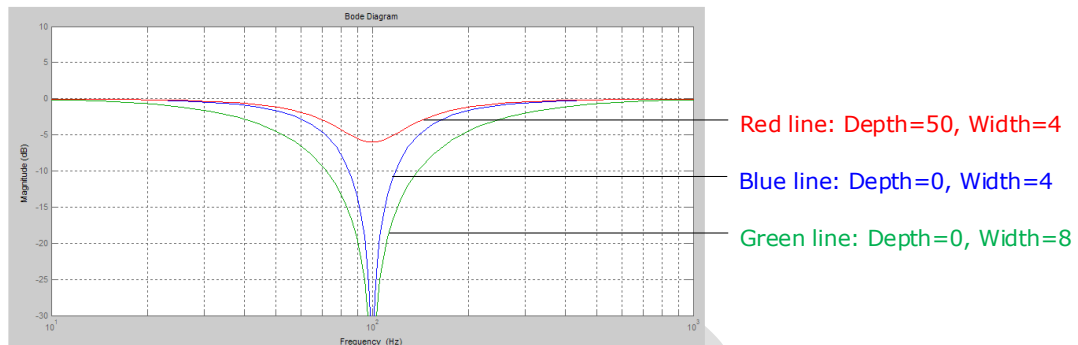

8.6.2 IF (Intermediate Frequency) Vibration Suppression

The IF vibration suppression filter is used to process the speed deviation and compensated to the torque reference. It is applied for the frequency range 100 Hz to 2000 Hz. Figure 8-20 shows the block diagram of using the IF vibration suppression filter.

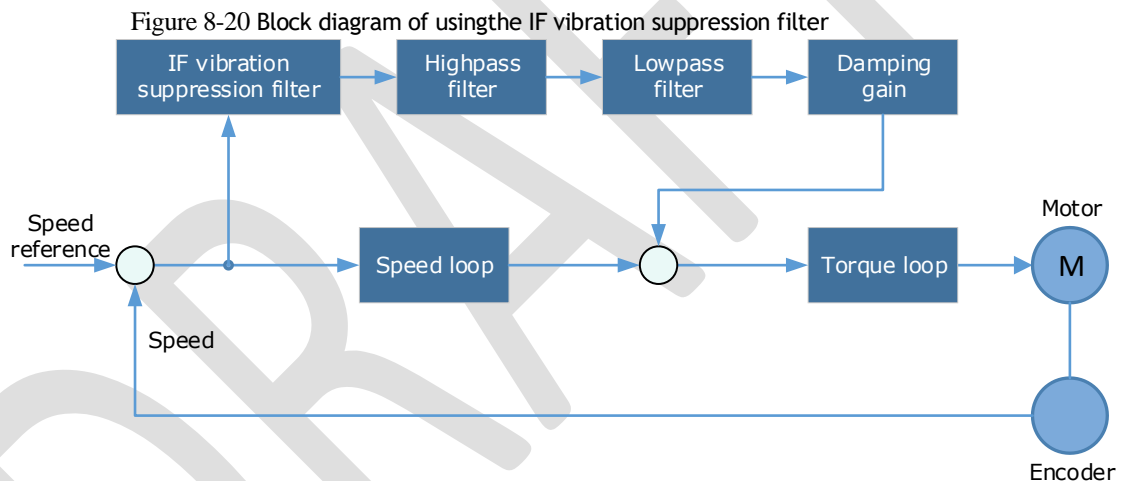

- Pn173 determines the frequency center at which vibration suppression is to be performed.
- Pn174 determines the vibration suppression bandwidth of the filter, indicating the range of the adjustment filter near the center frequency. Increase this setting can increase the range of vibration suppression, but it will affect the phase of the frequency near the center.
- The highpass filter and the lowpass filter are respectively used to filter high frequency DC signals and low frequency DC signals.
- Pn178 determines the level of the final compensated IF vibration suppression.

Parameter	Setting	Meaning	When Enabled	Classification
Pn173	-	Frequency of Vibration Suppression Filter	Immediately	Adjustment
Pn174	-	Adjust Bandwidth of Vibration Suppression Filter	Immediately	Adjustment
Pn175	-	Vibration Suppression	Immediately	Adjustment

Parameter	Setting	Meaning	When Enabled	Classification
Pn176	–	Lowpass Filter Time for Vibration Suppression	Immediately	Adjustment
Pn177	–	Highpass Filter Time for Vibration Suppression	Immediately	Adjustment
Pn178	–	Damping of Vibration Suppression Filter	Immediately	Adjustment

NOTE: Set Pn173 to 2000, indicating the notch filter is unavailable.

8.6.3 Load Oscillation Suppression

Use the Load Oscillation Suppression function for suppressing low frequency jitter at the end of the load during position control, as is shown in Figure 8-21.

Figure 8-21 Load Oscillation Suppression

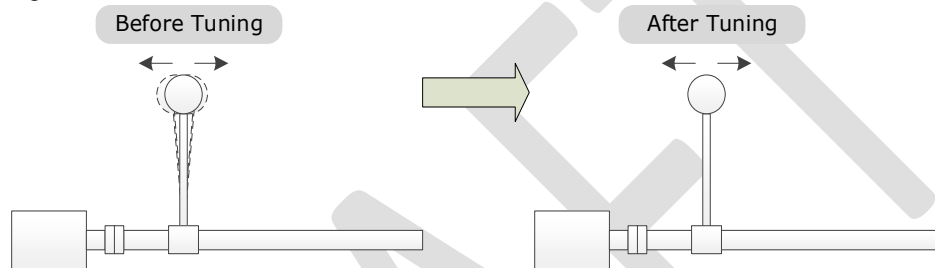

This function is based on the Model Following Control. According to the relationship between the load position and the Motor position in the Model Following Control, aiming at controlling the stability of the load position, and correcting the position reference, as well as the feedforward generated by the Model Following Control. Figure 8-22 shows the block diagram of using the Load Oscillation Suppression.

Figure 8-22 Load Oscillation Suppression

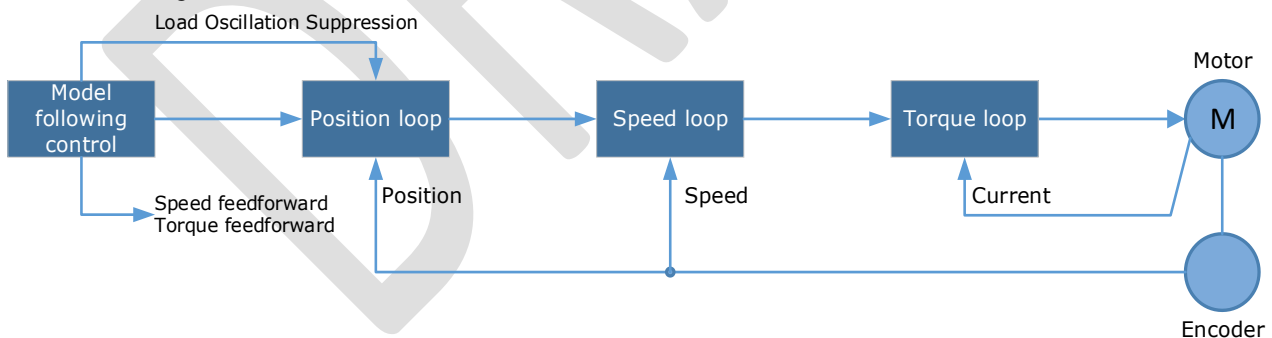

Parameter	Setting	Meaning	When Enabled	Classification
Pn150.0	2	Use the model following control and load oscillation suppression.	After restart	Function
Pn155	–	Load Oscillation Frequency	Immediately	Adjustment
Pn156	–	Filter Time for Load Oscillation Suppression	Immediately	Adjustment

Parameter	Setting	Meaning	When Enabled	Classification
Pn157	–	Limit for Load Oscillation Suppression	Immediately	Adjustment

- Pn155 determines frequency at which Load Oscillation Suppression is to be performed.
- Pn156 determines the filter time. You can increase this setting, and the filtering effect will be better. However, it may reduce the suppression effect due to the lag.
- You can set Limit for Load Oscillation Suppression (Pn157) as a proper limit value, helping to reduce overshooting during the start and stop.

Frequency Detection for Load Oscillation Suppression

If the frequency for the Load Oscillation Suppression can be detected by a measuring instrument (laser interferometer, etc.), please write the frequency data (in 0.1 Hz) into the Pn155 directly.

You can also use related functions in ESView V4 (FFT, etc.) to measure the frequency for the Load Oscillation Suppression.

Application Restrictions

The following application restrictions apply to the Load Oscillation Suppression.

- Load Oscillation Suppression can only be used when the Model Following Control is in effect.
- Only applied for the Manual Tuning.
- Only applied for the Position Control Modes.
- It is unavailable in fully-closed loop control.

8.6.4 Automatic Vibration Suppression

The automatic vibration suppression function determines the vibration state by the Motor during operation and recognizes the vibration frequency, and then selects the notch filter or the intermediate frequency vibration suppression function according to the characteristics of the vibration and automatically sets the vibration frequency.

The automatic vibration suppression function determines and detects the vibration frequency during the operation of the Motor, and then choose the notch filter or the IF suppression function, and set the relevant parameters for the vibration suppression.

Parameter	Setting	Meaning	When Enabled	Classification
Pn100.2	0 [Default]	Automatic Vibration Suppression is disabled.	After restart	Function
	1	Automatic Vibration Suppression is enabled.		
Pn179	–	Amplitude Threshold for Vibration Detection	Immediately	Adjustment

Pn179 determines the threshold of a frequency amplitude. If the detected frequency amplitude exceeds this setting, it will be regarded as a vibration.

Applied in Tuning-less, One-Parameter Auto-Tuning, Manual Tuning, and Manual-Tuning Tool

When the automatic vibration suppression function is applied in the Tuning-less, One-Parameter Auto-Tuning, Manual Tuning, and Manual-Tuning Tool, the following parameters can be set temporarily.

Parameter	Setting	Meaning	When Enabled	Classification
Pn184	–	Frequency of Notch Filter 2	Immediately	Adjustment
Pn173	–	Frequency of Vibration Suppression Filter	Immediately	Adjustment

Applied in Auto-Tuning Tool

When the automatic vibration suppression function is applied in the Auto-tuning Tool, the following parameters can be preset, and you can decide whether to write into the Drive.

Parameter	Setting	Meaning	When Enabled	Classification
Pn181	–	Frequency of Notch Filter 1	Immediately	Adjustment
Pn184	–	Frequency of Notch Filter 2	Immediately	Adjustment
Pn187	–	Frequency of Notch Filter 3	Immediately	Adjustment
Pn173	–	Frequency of Vibration Suppression Filter	Immediately	Adjustment

8.7 Diagnostic Tools

8.7.1 Load Inertia Identification

The Load Inertia Identification function is used to calculate the load inertia relative to the Motor rotor inertia (percentage of load inertia).

The Motor will rotate back and forth several times (the maximum rotations is 8) when using this function. You can change the number of Motor rotations for this function by the parameter Pn172.

Parameter	Setting	Meaning	When Enabled	Classification
Pn172	0 [Default]	8 rotations	Immediately	Function
	1	4 rotations		



- Stop the Motor running before performing this function.
- Ensure the movable parts have sufficient travel in the forward and reverse directions, as the Motor will run for up to 8 rotations during this operation.

Use the Panel Operator of the Drive

The following are the steps to execute the load inertia identification by using the Panel Operator.

- Step 1 Press [M] key several times to select the Utility Function Mode.



- Step 2 Press [▲] key or [▼] key to select the function number Fn009.



- Step 3 Press [◀] key, and Panel Operator displays as below.



- Step 4 Press [M] key to execute the load inertia identification.
At this time, Panel Operator displays the speed of the Motor in real time.

- Step 5 When this operation has been completed, Panel Operator will display the detection result (Unit: %).



NOTE: You can press the [M] key several times to execute this operation until the detection result is confirmed.

- Step 6 Press [▲] key to write the detection value to the parameter Pn106 (Load Inertia Percentage).



- Step 7 Press [◀] key to return to the display of the Fn009.

----End

Use the ESView V4

The following are the steps to execute the load inertia identification by using ESView V4.

- Step 1 Select **Advance** → **Load Inertia Identification** in the **Menu Bar** of the *ESView V4* main windows, as shown in Figure 8-23.

Figure 8-23 Load Inertia Identification

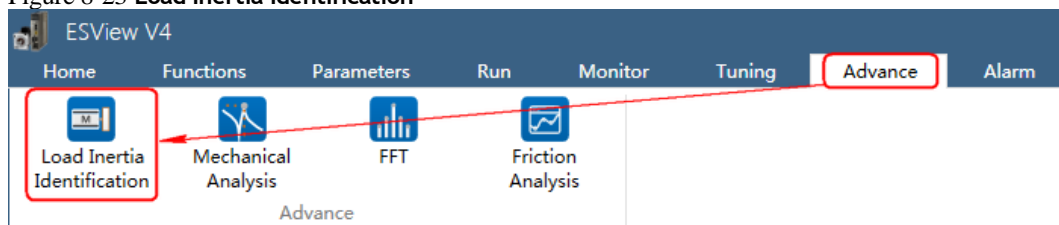

- Step 2 Read and follow the precautions in the warning box, and then click **OK**, as shown in

Figure 8-24 notes of load inertia identification

Load Inertia Identification

Load inertia detection is in the offline state, the servo internally generates the speed reference curve, and then the system inertia can be calculated from the motor speed and torque curve.

Precautions:

1. Please check if the adjacent space in the drive section is safe
The servo motor will rotate when this operation is performed. Please check carefully before performing the operation to confirm that the motor will not run dangerously.
2. Please ensure that there is enough space for motor movement
When this function is executed, the servo motor rotates back and forth at a certain speed during inertia detection to ensure that the motor has enough room for operation.
3. Move in the vertical direction
Since this operation is speed control, when S-ON, the shaft will fall under the action of gravity, do not perform this operation in proportional control mode.

OK

Step 3 Set **Circle Count** on the **Load Inertia Identification** dialog box, indicating the rotation number of the Motor when **Load Inertia Identification** function is performed.

PARAMETER SETTING

Circle Count Servo Off Run

TEST RESULTS

Pn106 Moment of Inertia... % Range : 0 ~ 9999

Save

Step 4 Click **Servo Off / Servo On** for supplying power to the Motor.

PARAMETER SETTING

Circle Count Servo Off Run

TEST RESULTS

Pn106 Moment of Inertia... % Range : 0 ~ 9999

Save

Step 5 Click **Run**.

PARAMETER SETTING

Circle Count Servo On

TEST RESULTS

Pn106 Moment of Inertia... % Range : 0 ~ 9999

Save

Step 6 When the **Load Inertia Identification** function has been completed, the result will be displayed in the textbox.

PARAMETER SETTING	
Circle Count	8Circle Servo Off <input type="checkbox"/> Run
TEST RESULTS	
Pn106 Moment of Inertia...	<input type="text" value="0"/> % Range : 0 ~ 9999
<input type="button" value="Save"/>	

Step 7 Click Save to write the value into the parameter Pn106 of the Drive.

PARAMETER SETTING	
Circle Count	8Circle Servo Off <input type="checkbox"/> Run
TEST RESULTS	
Pn106 Moment of Inertia...	<input type="text" value="0"/> % Range : 0 ~ 9999
<input type="button" value="Save"/>	

---End

8.7.2 Mechanical Analysis



Stop the Motor running before performing this function.

This function measures the frequency characteristics of a mechanical system where a Drive is connected to a PC. It enables the measurement of mechanical frequency characteristics without the use of special equipment.

Step 1 Select **Advance** → **Mechanical Analysis** in the **Menu Bar** of the *ESView V4* main windows.

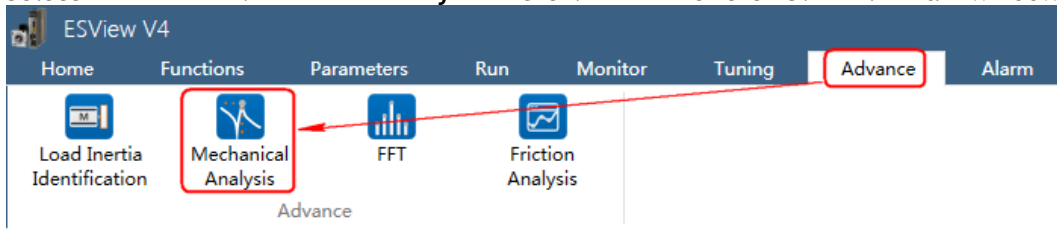

Step 2 The **Mechanical Analysis** window will be displayed in **Function Display Area**.

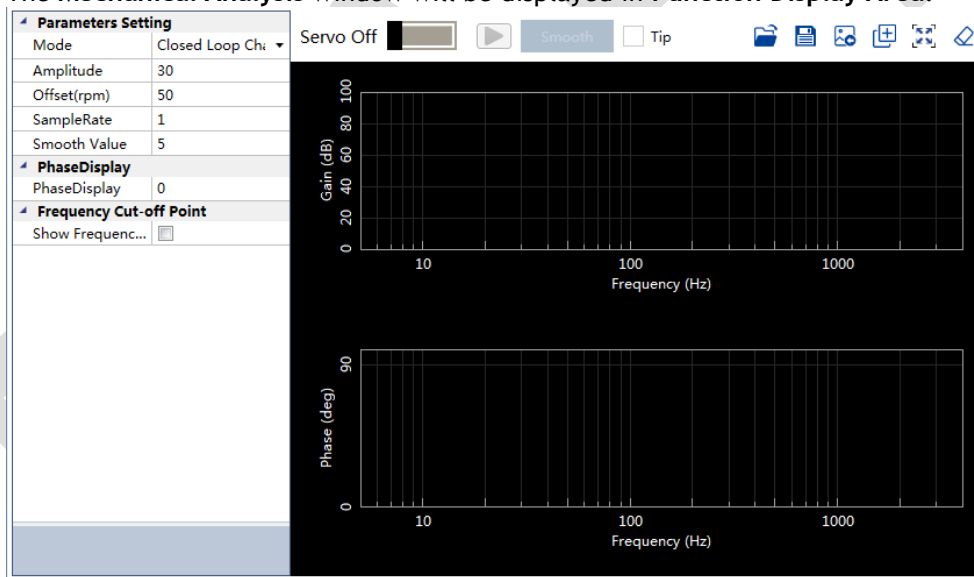

Step 3 Set the necessary parameters before performing the **Mechanical Analysis** function.

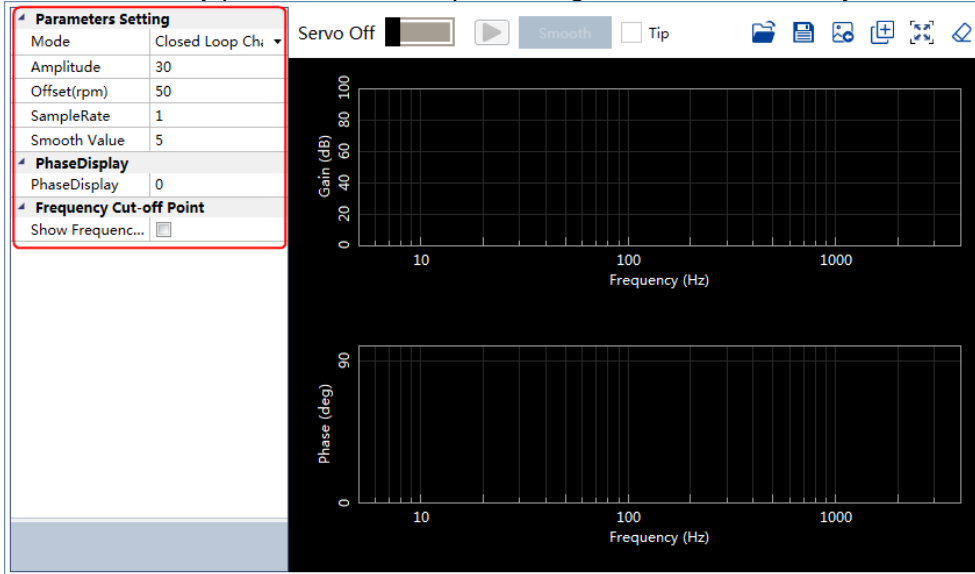

Step 4 Click **Servo Off / Servo On** for supplying power to the Motor.

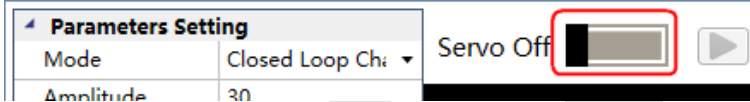

Step 5 Click  to start the **Mechanical Analysis** function.

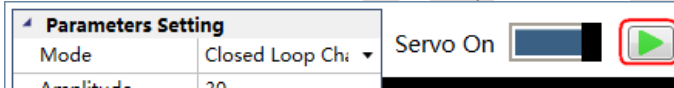

Step 6 When the **Mechanical Analysis** function has been completed, the waveform graphics of the data result is displayed in the window.

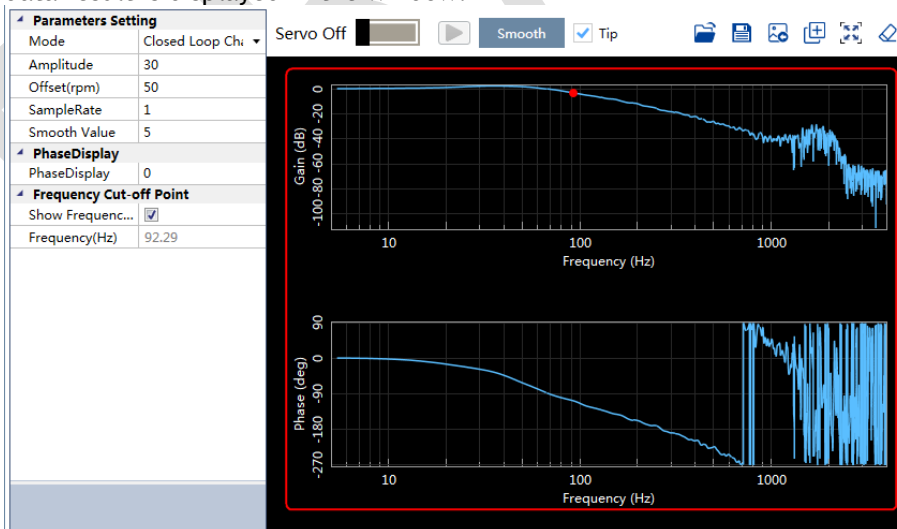

----End

8.7.3 FFT

This function can analyze the vibration frequency of the machine and draw the graphics on the window when the Motor is running.

Step 1 Select **Advance** → **FFT** in the **Menu Bar** of the *ESView V4* main windows.

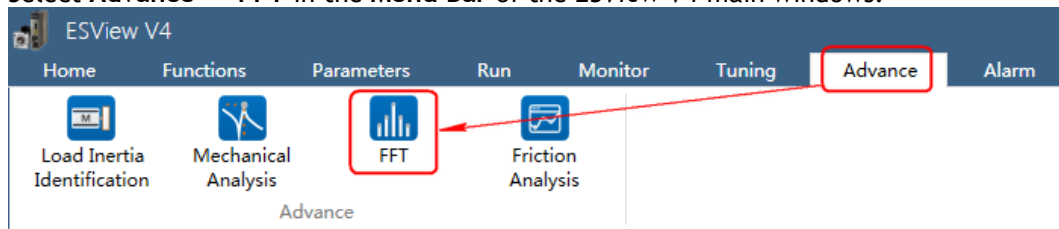

Step 2 The FFT window will be displayed in Function Display Area.

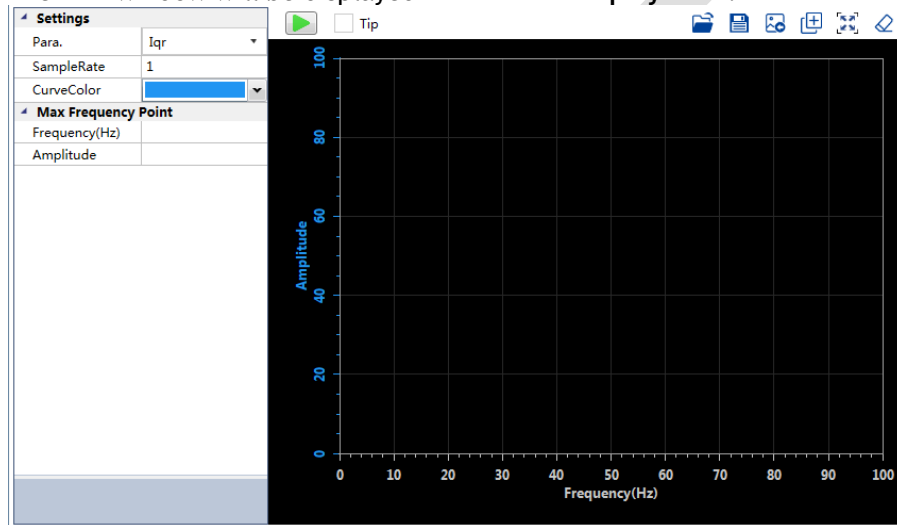

Step 3 Set the necessary parameters before performing the FFT function.

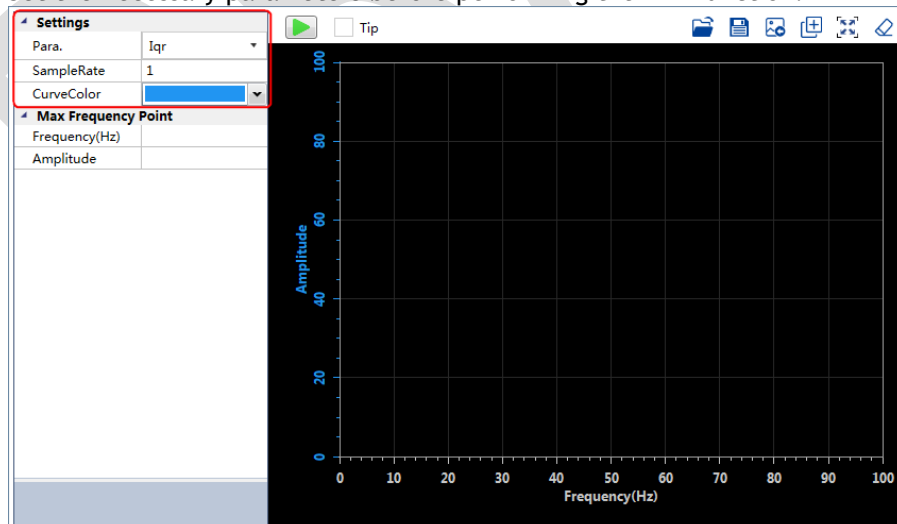

Step 4 Click  to start the FFT function.

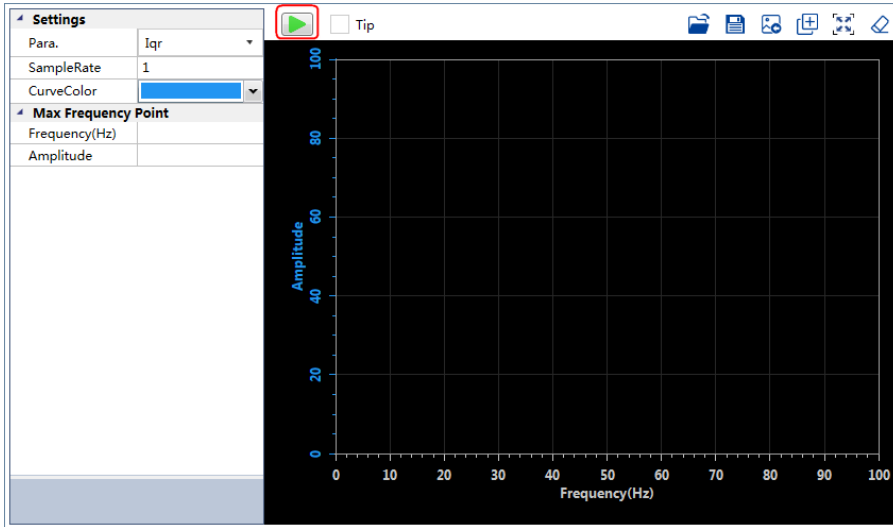

Step 5 When the FFT function has been completed, the waveform graphics of the data result is displayed in the window.

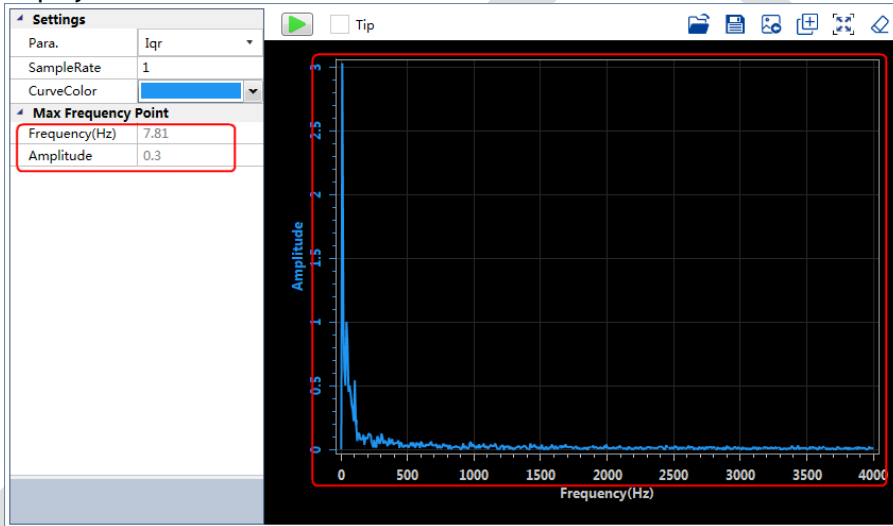

----End

8.7.4 Friction Analysis



Stop the Motor running before performing this function.

The parameters related to friction compensation of the Servo system can be set according to the friction characteristics of the Motor operation.

Step 1 Select **Advance** → **Friction Analysis** in the **Menu Bar** of the *ESView V4* main windows.

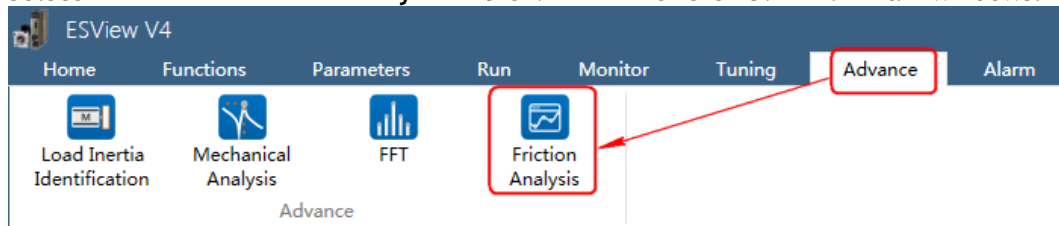

Step 2 Read and follow the precautions in the warning box, and then click **OK**.

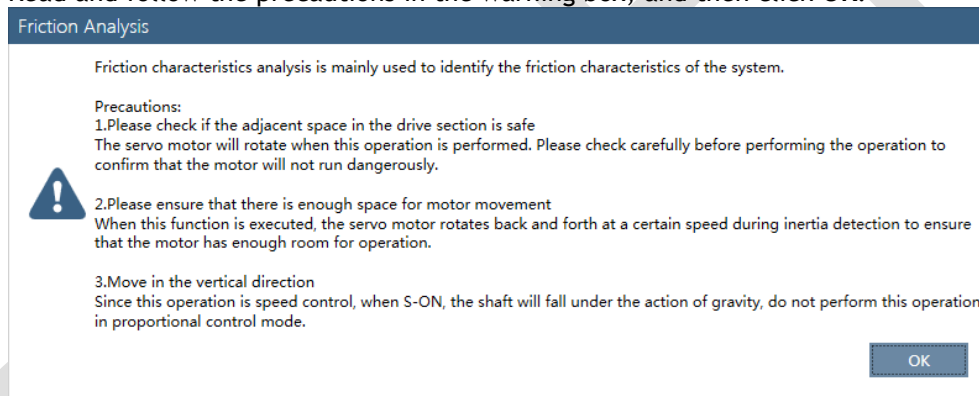

Step 3 The **Friction Analysis** window will be displayed in **Function Display Area**.

Step 4 Click **Detect** to perform Load Inertia Identification function if necessary.

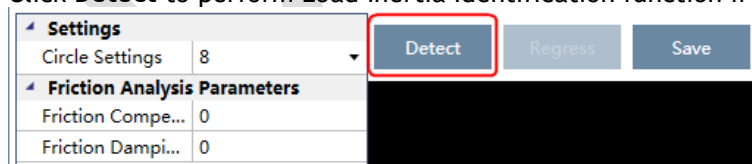

Step 5 Set **Circle Settings** for the Motor rotation when performing **Friction Analysis** function.

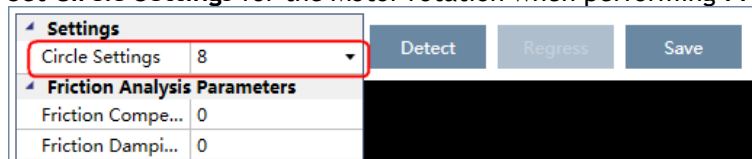

Step 6 Click **Servo Off / Servo On** for supplying power to the Motor.

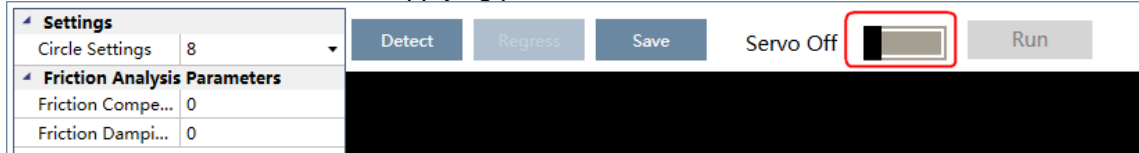

Step 7 Click **Run**.



Step 8 When the **Friction Analysis** function has been completed, the waveform graphics of the data result is displayed in the window.

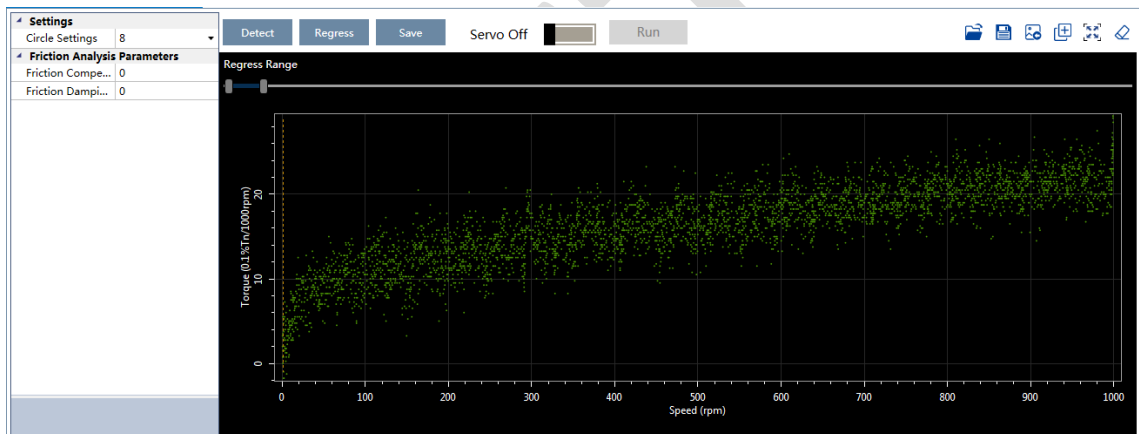

Step 9 Move **Regress Range** for setting a proper analysis range of Speed.

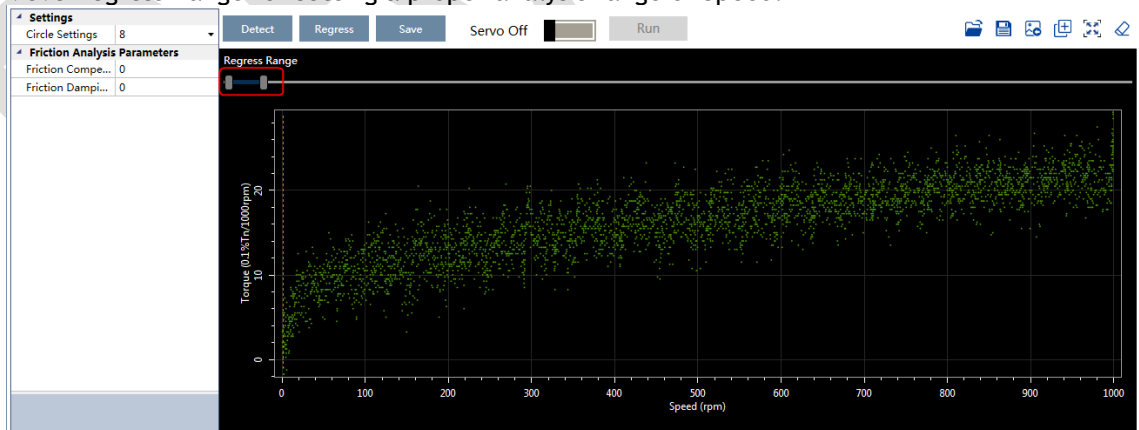

Step 10 Click **Regress** for calculating the **Friction Compensation Gain** and **Friction Damping Proportion**.

Step 11 Click **Save** to write **Friction Compensation Gain** and **Friction Damping Proportion** into the parameters Pn130 and Pn132 of the Drive.

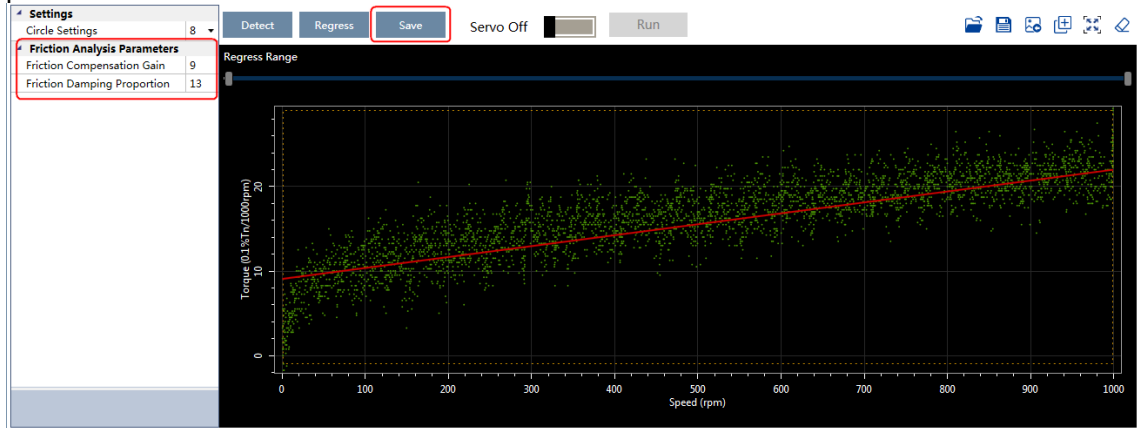

----End

DRAFT

Chapter 9 MODBUS Communications

9.1 Communication Wiring

The connection terminals CN3-IN and CN4-OUT are used for MODBUS communications.

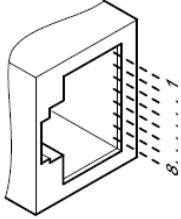
Connector	Pin	Definition	Description
	3	RS485+	RS-485 communication terminal +
	4	GNDW	Signal GND
	5	GNDW	
	6	RS485-	RS-485 communication termina-
	Housing	FG	Shielded wire is connected to the housing

[Note] The signal definitions of CN3-IN and CN4-OUT are the same.

9.2 Setting Communication Parameters

Number	Name	Setting & Meaning	When Enabled
Pn700.0	MODBUS Communication Baud Rate	[0]: 4800bps [1]: 9600bps [2]: 19200bps	After restart
Pn700.1	Communication Protocol	[0]: 7, N, 2 (Modbus, ASCII) [1]: 7, E, 1 (Modbus, ASCII) [2]: 7, O, 1 (Modbus, ASCII) [3]: 8, N, 2 (Modbus, ASCII) [4]: 8, E, 1 (Modbus, ASCII) [5]: 8, O, 1 (Modbus, ASCII) [6]: 8, N, 2 (Modbus, RTU) [7]: 8, E, 1 (Modbus, RTU) [8]: 8, O, 1 (Modbus, RTU)	
Pn700.2	Communication Protocol Selection	[0] No protocol SCI communication [1] MODBUS SCI communication	
Pn701	Axis Address	Axis address of MODBUS protocol communication	

9.3 MODBUS Communication Protocol

MODBUS communication protocol is only used when Pn700.2 is set to 1. There are two modes for MODBUS communication: ASCII (American Standard Code for information interchange) mode and RTU (Remote Terminal Unit) mode.

9.3.1 Code Meaning

ASCII Mode

Every 8-bit data is consisted by two ASCII characters. For example: One 1-byte data 64_H (Hexadecimal expression) is expressed as ASCII code '6', which contains '6' as ASCII code 36_H and '4' as ASCII code 34_H.

ASCII code for number 0 to 9, character A to F are as follows:

Character	'0'	'1'	'2'	'3'	'4'	'5'	'6'	'7'
ASCII Code	30 _H	31 _H	32 _H	33 _H	34 _H	35 _H	36 _H	37 _H
Character	'8'	'9'	'A'	'B'	'C'	'D'	'E'	'F'
ASCII Code	38 _H	39 _H	41 _H	42 _H	43 _H	44 _H	45 _H	46 _H

RTU Mode

Every 8-bit data is consisted by two 4-bit hexadecimal data, that is to say, a normal hexadecimal data. For example: decimal data 100 can be expressed as 64_H by 1-byte RTU data.

Data Structure

- 10bit character form (7-bit data)

Pn700.1 = 0: 7, N, 2 (Modbus, ASCII)

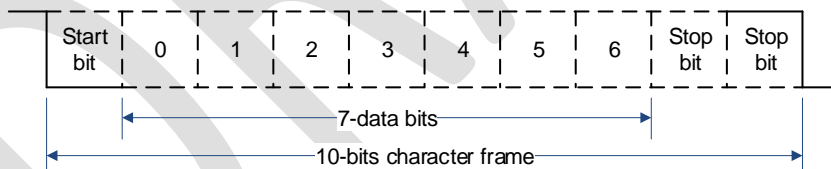

Pn700.1 = 1: 7, E, 1 (Modbus, ASCII)

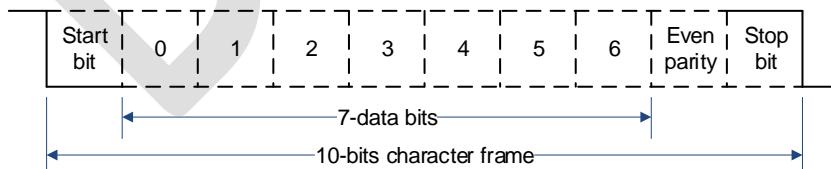

Pn700.1 = 2: 7, O, 1 (Modbus, ASCII)

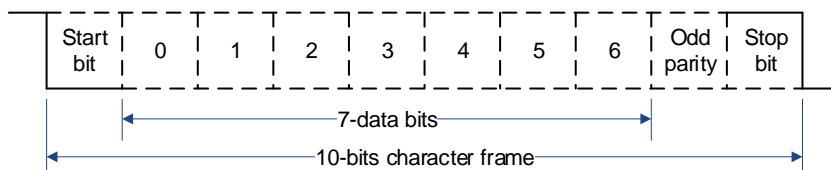

- 11bit character form (8-bit data)

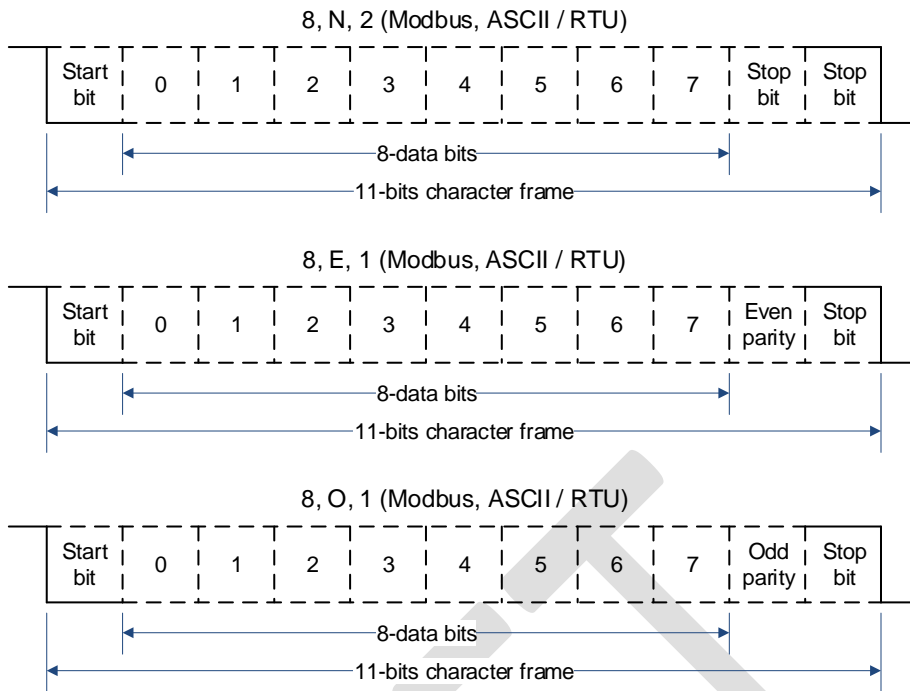

9.3.2 Communication Protocol Structure

ASCII Mode

STX	Start character: ' ' => (3A _H)
ADR	Communication address => 1-byte contains two ASCII codes
CMD	Reference code => 1-byte contains two ASCII codes
DATA(n-1)	Data content => n-word=2n-byte contain 4nASCII codes, n ≤ 12
.....	
DATA(0)	
LRC	Checking code=> 1-byte contains two ASCII codes
End 1	End code 1=> (0D _H) (CR)
End 0	End code 0=> (0A _H) (LF)

RTU Mode

STX	Sleep interval of at least 4 bytes transmission time.
ADR	Communication address => 1-byte
CMD	Reference code => 1-byte
DATA(n-1)	Data content => n-word=2n-byte, n ≤ 12
.....	
DATA(0)	
CRC	CRC checking code => 1-byte
End 1	Sleep interval of at least 4 bytes transmission time.

Communication protocol data format instructions

- STX (communication start)
 - ASCII mode: ‘:’ character
 - RTU mode: Sleep interval of at least 4 bytes transmission time (automatically changed according to different communication speed).

- ADR (communication address)

Valid communication address: 1 to 254

For example: communicate with the servo drive which address is 32 (20 in hex):

- ASCII mode: ADR=‘2’, ‘0’=> ‘2’=32_H, ‘0’=30_H
- RTU mode: ADR=20_H

- CMD (command reference) and DATA (data)

Data structure is determined by command code. Regular command code is shown as follows: Command code: 03H, read N words(word), $N \leq 20$.

For example: read 2 words starting from 0070_H from the servo drive which address is 01_H.

ASCII Mode			
Reference Information		Response Information	
STX	“:”	STX	“:”
ADR	‘0’	ADR	‘0’
	‘1’		‘1’
CMD	‘0’	CMD	‘0’
	‘3’		‘3’
Data start address	‘0’	Data number (count as byte)	‘0’
	‘0’		‘4’
	‘7’	Content of data start address 0200 _H	‘0’
	‘0’		‘0’
Data number (count as word)	‘0’	Content of second data address 0201 _H	‘0’
	‘0’		‘0’
	‘0’		‘0’
	‘2’		‘0’
LRC checking	‘8’	LRC checking	‘F’
	‘A’		‘8’
End 1	(0D _H)(CR)	End 1	(0D _H)(CR)
End 0	(0A _H)(LF)	End 0	(0A _H)(LF)

RTU Mode			
Reference Information		Response Information	
ADR	01 _H	ADR	01 _H
CMD	03 _H	CMD	03 _H
Data start address	00 _H (high-bit)	Data number (count as byte)	04 _H
	70 _H (low-bit)		
Data number (count as word)	00 _H	Content of data start address 0200 _H	00 _H (high-bit)
	02 _H		00 _H (low-bit)
CRC checking	C5 _H (low-bit)	Content of second data address 0201 _H	00 _H (high-bit)
CRC checking	D0 _H (high-bit)		00 _H (low-bit)
		CRC checking	FA _H (low-bit)
		CRC checking	33 _H (high-bit)

For example: write 1(0001_H) into 01_H servo address 0070_H. Reference code: 06_H, write in one word

ASCII Mode			
Reference Information		Response Information	
STX	“: ”	STX	“: ”
ADR	‘0’	ADR	‘0’
	‘1’		‘1’
CMD	‘0’	CMD	‘0’
	‘6’		‘6’
Data start address	‘0’	Data number (count as byte)	‘0’
	‘0’		‘4’
	‘7’	Content of data start address 0200 _H	‘0’
	‘0’		‘0’
Data content	‘0’	Content of second data address 0201 _H	‘7’
	‘0’		‘0’
	‘0’		‘0’
	‘1’		‘1’
LRC checking	‘8’	LRC checking	‘8’
	‘8’		‘8’
End 1	(0D _H)(CR)	End 1	(0D _H)(CR)
End 0	(0A _H)(LF)	End 0	(0A _H)(LF)

RTU Mode			
Reference Information		Response Information	
ADR	01 _H	ADR	01 _H
CMD	06 _H	CMD	06 _H
Data start address	00 _H (high-bit)	Data start address	00 _H (high-bit)
	70 _H (low-bit)		70 _H (low-bit)
Data content	00 _H (high-bit)	Data content	00 _H (high-bit)
	01 _H (low-bit)		01 _H (low-bit)
CRC checking	49 _H (low-bit)	CRC checking	49 _H (low-bit)
CRC checking	D1 _H (high-bit)	CRC checking	D1 _H (high-bit)

LRC (ASCII mode) and CRC (RTU mode) Error Detection Value Calculation

- LRC calculation in ASCII mode:

ASCII mode uses LRC (Longitudinal Redundancy Check) error detection value. The exceeded parts (e.g. the total value is 128_H of hex, then take 28_H only) is taken off by the unit of 256 in the total value from ADR to the last information, then calculate and compensate, the final result is LRC error detection value.

For example: read 1 word from 01_H servo address 0201

STX	‘:’
ADR	‘0’
	‘1’
CMD	‘0’
	‘3’
Data start address	‘0’
	‘2’
	‘0’
	‘1’
Data number (count as word)	‘0’
	‘0’
	‘0’
	‘1’
LRC checking	‘F’
	‘8’
End 1	(0D _H)(CR)
End 0	(0A _H)(LF)

Add from ADR data to the last data.

$01_{\text{H}} + 03_{\text{H}} + 02_{\text{H}} + 01_{\text{H}} + 00_{\text{H}} + 01_{\text{H}} = 08_{\text{H}}$

The compensate value is $F8_{\text{H}}$ when 2 is used to compensate 08_{H} , so LRC is "F", "8".

- CRC calculation of RTU mode:

RTU mode uses CRC (Cyclical Redundancy Check) error detection value.

The process of CRC error detection value calculation is shown as follows:

Step 1: Load in a 16-bit register of $FFFF_{\text{H}}$, named "CRC" register.

Step 2: Run XOR calculation between the first bit (bit 0) of instruction information and 16-bit CRC register's low bit (LSB), and the result is saved to CRC register.

Step 3: Check the lowest bit (LSB) of CRC register, if it is 0, CRC register moves one bit to right; if it is 1, CRC register moves one bit to right, then run XOR calculation with $A001_{\text{H}}$;

Step 4: Go to step 5 till the third step has been executed for 8 times, otherwise return to step 3.

Step 5: Repeat the steps from 2 to 4 for the next bit of instruction information, the content of CRC register is the CRC error detection value while all the bits have been executed by the same way.

DRAFT

Example

After calculating out the CRC error detection value, the CRC low bit should be filled first in instruction information, and then fill the high bit of CRC. Refer to the following example.

Read 2 words from the 0101_H address of 01_H servo. The final CRC register content calculated from ADR to the last bit of data is 94_H, and then the instruction information is shown as follows. Please be sure that 94_H is transmitted before 37_H.

ADR	01 _H
CMD	03 _H
Data start address	01 _H (high-bit)
	01 _H (low-bit)
Data number (count as word)	00 _H (high-bit)
	02 _H (low-bit)
CRC checking	94 _H (low-bit)
CRC checking	37 _H (high-bit)

End1, End0 (Communication is completed.)

- ASCII Mode:
Communication is ended with (0D_H) - [carriage return] and (0A_H) - [new line].
- RTU Mode
When the time exceeds the sleep interval by at least 4 bytes transmission time while in the current communication speed, it means the communication is finished.

9.3.3 Communication Error Disposal

Problems that occur during communication are a result of the following:

- Data address is incorrect while reading/writing parameters.
- The data is not within the parameter setting range while writing.
- Data transmission fault or checking code fault when communication is disturbed.

When the first and second communication faults occur, the servo drive is running normally, and will feed back an error frame.

When the third communication fault occurs, transmission data will be recognized as invalid to give up, and no error frame is returned.

The format of error frame:

Host controller data frame:				
start	Slave station address	Command	Data address, content	Checking
–	–	command	–	–

Servo drive feeds back error frame:				
start	Slave station address	Response code	Error code	Checking

Servo drive feeds back error frame:				
–	–	Command + 80 _H	–	–

Error frame responses code=command+80_H;

Error code = 00_H: Normal communication

= 01_H: Servo drive cannot identify the required functions

= 02_H: The required data address does not exist in the servo drive

= 03_H: The required data in servo drive is not allowed (beyond the maximum or minimum value of the parameter)

= 04_H: Servo drive starts to perform the requirement, but cannot achieve it.

For example: Servo drive axis number is 03_H, write data 5000 into parameter Pn102 is not allowed, because the range of parameter Pn102 is 1~4000. The servo drive will feedback an error frame, the error code is 03_H (beyond the parameter's maximum value or minimum value). The structure is as follows:

Host controller data frame				
start	Slave station address	Command	Data address, content	Checking
–	03 _H	06 _H	0066 _H 1388 _H	–

Servo drive feedback error frame:				
start	Slave station address	Response code	Error code	Checking
–	03 _H	86 _H	03 _H	–

Besides, if the data frame sent from host controller slave station address is 00_H, it determines the data to be broadcast data. The servo drives will not feedback any frames.

9.3.4 Data Communication Address of Servo State

Data Address	Meaning	Description	Operation
01F0 ~ 0B47	Parameter area	Corresponding parameters in parameter list	Read/write
1011 ~ 101A	Alarm information memory area	Ten alarms historical record	Read only
0F00	Virtual DI input		Read/write
0E8C	DI status	Un005	Read only

Data Address	Meaning	Description	Operation
0E8D	TouchProbe input status	Un006	Read only
0E8E	DO status	Un007	Read only
0E86	Speed feedback	Un000	Read only
0E87	Speed setting	Un001	Read only
0E88	Input torque reference percentage	Un002	Read only
0E89	Internal torque reference percentage	Un003	Read only
0E8A ~ 0E8B	Encoder rotation pulse number	Un004	Read only
0E8F	Pulse setpoint of 1ms	Un008	Read only
0E90 ~ 0E93	Current position	Un009	Read only
0E94 ~ 0E97	Deviation pulse counter	Un011	Read only
0E98 ~ 0E9B	Given position	Un013	Read only
0E9C	Percentage of load inertia	Un015	Read only
0E9D	Motor overload ratio	Un016	Read only
0EAD	Servo current alarm number		Read only
0F3A	Encoder multi-turn information		Read only
0F3B ~ 0F3C	Encoder single-turn information		Read only
1021	Clear historical alarms		Write only
1022	Clear current alarms		Write only
1040	Clear encoder alarm		Write only
1041	Clear encoder multi-turn data		Write only

Servo Parameter Area

The Pn parameter of corresponding servo. Pn parameter is 32bit, formed by splicing two consecutive hexadecimal data addresses (low- and high-bit). When reading and writing, operate the low-bit first, then high-bit.

For the start parameter Pn000, the low-bit address is 01F0_H, and the high-bit address is 01F1_H.

For other parameters Pnx, the low-bit address is 01F0_H+x*2, and the high-bit address is 01F1_H+x*2.

For example: when writing to Pn000, the data written is 1; write 1 to 01F0_H first, and then write 0 to 01F1_H.

Alarm Information Storage Area





Historical Alarm Number	Description	Communication Address
0	Historical alarm 1 (the latest alarm)	1101 _H
1 ~ 8	Historical alarms 2 ~ 9	1102 _H ~ 1109 _H
9	Historical alarm 10 (the furthest alarm)	101A _H

DRAFT

Chapter 10 Alarm Displays

10.1 Alarm Classifications

There are three classifications of alarms for the Drive: Gr.1, Gr.2, and Warning. They will affect the display and operation for the Servo System.

Classification	Stopping Method	Panel Display
Gr.1	Stops the Motor according to the setting of Pn003.0. For details, refers to 5.4.1 Motor Stop Methods for Gr.1 Alarms, Safety State and Servo OFF.	The Panel Operator displays between Alarm No and Servo state FLT by turns. 
Gr.2	Stops the Motor according to the setting of Pn004.0 For details, refers to 0	
Warning	Do not stop the Motor, and keep the current operation	The Panel Operator displays between Alarm No and Servo state run by turns.  

10.2 Alarm Detailed

10.2.1 Gr.1 Warning

A.01: Parameter destruction

Possible causes	Confirm the method	Action
The supply voltage drops instantaneously	Measure the supply voltage.	The supply voltage is set within the specification range and the initialization of the parameter setpoint is performed.
Parameters are written to interrupt power	Confirm the time of the power outage.	Re-write the parameter after restoring the factory value of the parameter (Fn001).
Malfunction due to noise	Confirm the runtime environment.	Take anti-interference countermeasures and then power the drive back in.
Drive failure	Power on the drive. When an alert still occurs, it may be a drive failure.	Replace the drive.

A.03: Motor overspeed

Possible causes	Confirm the method	Action
The U, V, W phase sequence of the motor wiring is incorrect	Confirm the wiring of the motor.	Confirm if there is a problem with the motor wiring.
The instruction input value exceeds the overspeed value	Confirm the input instruction.	Lower the instruction value, or adjust the gain.
The motor speed exceeds the maximum speed	Confirm the waveform of the motor speed.	Reduce the speed command input gain or adjust the setting of the Pn323 (Overspeed Alarm Detection Threshold).
Drive failure	Power on the drive. When an alert still occurs, it may be a drive failure.	It may be a drive failure. Replace the drive.

A.04: Overload

Possible causes	Confirm the method	Action
Motor wiring, encoder wiring, or poor connection	Confirm the wiring.	Check whether there is a problem with the motor wiring and encoder wiring.
The motor runs beyond the overload protection characteristics	Confirm the overload characteristics and operating instructions of the motor.	Revisit load conditions and operating conditions. Or revisit the motor capacity.

Possible causes	Confirm the method	Action
Due to mechanical factors, the motor is not driven, resulting in excessive load during operation	Confirm the operating instructions and motor speed.	Improve mechanical factors.
Drive failure	Power on the drive. When an alert still occurs, it may be a drive failure.	Replace the drive.

A.05: The position deviation counter overflows

Possible causes	Confirm the method	Action
The wiring of the motor U, V, W is incorrect	Confirm the wiring of the motor main circuit cable.	Confirm that the motor cable or encoder cable has problems such as poor contact.
Position commands are too fast	Try lowering the position command speed before running.	Lower the position command speed or command acceleration, or adjust the electronic gear ratio.
The position instruction accelerates too much	Try slowing down the instruction acceleration before running.	With the EtherCAT command, the position command acceleration is reduced.
Deviation counter overflow alarm (Pn504) is low relative to operating conditions	Confirm that the position deviation counter overflow alarm (Pn504) is appropriate.	Correctly set the value of the parameter Pn504.
Drive failure	Power on the drive. When an alert still occurs, it may be a drive failure.	Replace the drive.

A.06: The position deviation pulse overflows

Possible causes	Confirm the method	Action
Servo ON is maintained when the position deviation in servo OFF exceeds the setpoint of (Pn504× electronic gear).	Confirm the amount of positional deviation when servo OFF.	Set the correct deviation counter overflow alarm (Pn504) when servo ON.

A.07: The electronic gear setting or pulse frequency is unreasonable

Possible causes	Confirm the method	Action
The setting of the electronic gear ratio: Pn725/Pn726 (6093-01h/6093-02h) is not within the set range	Confirm that the electronic gear ratio is within a reasonable range	The setting range of the electronic gear ratio depends on the number of encoder bits: Encoder bits ≤ 20 , set range: [0.001, 4000] Encoder bits ≤ 21 , set range: [0.001, 8000] Encoder bits ≤ 22 , set range: [0.001, 16000] Encoder bits ≤ 23 , set range: [0.001, 32000] Encoder bits ≤ 24 , set range: [0.001, 64000]

A.08: There is a problem with the first channel of current detection

Possible causes	Confirm the method	Action
Drive failure	Power on the drive. When an alert still occurs, it may be a drive failure.	Replace the drive.

A.09: There is a problem with the second channel of current detection

Possible causes	Confirm the method	Action
Drive failure	Power on the drive. When an alert still occurs, it may be a drive failure.	Replace the drive.

A.12: Overcurrent

Possible causes	Confirm the method	Action
The main circuit cable is wired incorrectly, or the contact is poor	Confirm that the wiring is correct.	Modify the wiring.
The main loop cable is shorted internally or a short-to-ground circuit has occurred	Confirm whether a short circuit has occurred between the UVW phases of the cable and between the UVW and the ground.	There is a possibility that the cable will be short-circuited. Replace the cable.
A short circuit or a short circuit to the ground occurs inside the motor	Confirm whether a short circuit has occurred between the UVW phases of the motor terminals and between the UVW and the ground.	It is possible that the motor is faulty. Replace the motor.
A short circuit or short-to-ground circuit occurs inside the drive	Confirm whether a short circuit has occurred between the UVW phases of the motor connection terminals of the drive and between the UVW and the ground.	It may be a drive failure. Replace the drive.

Possible causes	Confirm the method	Action
The braking resistor is wired incorrectly or has poor contact	Confirm that the wiring is correct.	Modify the wiring.
Dynamic brakes (emergency stops due to DB or drives) are used frequently, or DB brake circuit damage alarms occur	The DB usage frequency is confirmed by the DB resistor power dissipation. Or use the alarm display to confirm if damage to the DB braking circuit (A.1B) has occurred.	变更驱动器的选型、运行方法和机构，以降低 DB 的使用频率。
Exceeds the braking capacity	Confirm how often the braking resistor is used.	Change the selection, operating method, and mechanism of the drive to reduce the frequency of DB usage.
The braking resistance value of the drive is too small	Confirm how often the braking resistor is used.	Change the braking resistance value to a value above the minimum allowable resistance value of the drive.
High loads are tolerated when the motor is stopped or when running at low speeds	Confirm that the operating conditions are outside the specification range of the servo drive.	Reduce the load on the motor. Or run at a higher operating speed.
Malfunction due to noise	Improve the noise environment such as wiring and settings to confirm whether there is any effect.	Take anti-interference measures, such as correct wiring of FG. In addition, please use a wire with the same size as the driver main circuit wire for the FG wire size.
Drive failure	Power on the drive. When an alert still occurs, it may be a drive failure.	Replace the drive.

A.13: Overvoltage

Possible causes	Confirm the method	Action
The supply voltage is out of specification	Measure the supply voltage.	Adjust the AC/DC supply voltage to the product specifications.
The power supply is in an unstable state or has been affected by lightning strikes	Measure the supply voltage.	Improve power conditions and power the drive again after setting the surge suppressor. When an alert still occurs, it may be a drive failure. Replace the drive.
Acceleration and deceleration occur when the AC supply voltage exceeds the specification range	Confirm the supply voltage and speed and torque during operation.	Adjust the AC supply voltage to the product specifications.

Possible causes	Confirm the method	Action
The external braking resistance value is larger than the operating conditions	Confirm the operating conditions and braking resistance values.	Considering the operating conditions and loads, the braking resistance value is revisited.
Operates above the allowable moment of inertia or mass ratio	Confirm that the moment of inertia or mass ratio is within the allowable range.	Extend the deceleration time or reduce the load.
Drive failure	Power on the drive. When an alert still occurs, it may be a drive failure.	Replace the drive.

A.14: Undervoltage

Possible causes	Confirm the method	Action
The supply voltage is below specification	Measure the supply voltage.	Regulate the supply voltage to the normal range.
The supply voltage drops during operation	Measure the supply voltage.	Increase the power supply capacity.
An instantaneous power outage occurs	Measure the supply voltage.	If the instantaneous stop hold time (Pn538) is changed, it is set to a smaller value.
The fuse of the drive is blown	–	Replace the drive, connect the reactor to the DC reactor connection terminals (P1, P2), and use the drive.
Drive failure	Power on the drive. When an alert still occurs, it may be a drive failure.	Replace the drive.

A.16: Regeneration abnormalities

Possible causes	Confirm the method	Action
The drive requires an external braking resistor	Confirm the connection of the external regenerative resistor and check the setpoints of Pn535 and Pn536.	After connecting the external braking resistor, set Pn535 and Pn536 to the appropriate values.
When an external braking resistor is not used, the short wiring of B2 and B3 falls off	Confirm the connection of the short wires of B2 and B3.	Properly wire the short wiring.
External regenerative resistors are poorly wired, detached, or disconnected	Confirm the wiring of the external regenerative resistor.	Properly wired external regenerative resistors.

Possible causes	Confirm the method	Action
Drive failure	Power on the drive. When an alert still occurs, it may be a drive failure.	Replace the drive.

A.18: The module is overheating

Possible causes	Confirm the method	Action
The ambient temperature is too high	Measure the ambient temperature with a thermometer. Or confirm health through drive provisioning environment monitoring.	Improve drive setup conditions and reduce ambient temperature.
The overload alarm was reset several times by powering it off and then running	Use the alert display to confirm if an overload alert has occurred.	Change the reset method for the alert.
The load is too heavy, or the regeneration capacity is exceeded during operation	The load in operation is confirmed by the cumulative load rate, and the regenerative processing capacity is confirmed by the regenerative load rate.	Revisit load conditions and operating conditions.
The orientation of the drive and the spacing from other drives are unreasonable	Confirm the setup status of the drive.	Install according to the installation standards of the drive.
Drive failure	Power on the drive. When an alert still occurs, it may be a drive failure.	Replace the drive.

A.1D: The temperature sensor is disconnected

Possible causes	Confirm the method	Action
The ambient temperature is too high	Measure the ambient temperature with a thermometer. Or confirm health through drive provisioning environment monitoring.	Improve drive setup conditions and reduce ambient temperature.
The overload alarm was reset several times by powering it off and then running	Use the alert display to confirm if an overload alert has occurred.	Change the reset method for the alert.
The load is too heavy, or the regeneration capacity is exceeded during operation	The load in operation is confirmed by the cumulative load rate, and the regenerative processing capacity is confirmed by the regenerative load rate.	Revisit load conditions and operating conditions.

Possible causes	Confirm the method	Action
The orientation of the drive and the spacing from other drives are unreasonable	Confirm the setup status of the drive.	Install according to the installation standards of the drive.
Drive failure	Power on the drive. When an alert still occurs, it may be a drive failure.	Replace the drive.

A.1E: The main charge circuit is faulty

Possible causes	Confirm the method	Action
The drive requires an external braking resistor	Confirm the connection of the external regenerative resistor and check the setpoints of Pn535 and Pn536.	After connecting the external braking resistor, set Pn535 and Pn536 to the appropriate values.
When an external braking resistor is not used, the short wiring of B2 and B3 falls off	Confirm the connection of the short wires of B2 and B3.	Properly wire the short wiring.
External regenerative resistors are poorly wired, detached, or disconnected	Confirm the wiring of the external regenerative resistor.	Properly wired external regenerative resistors.
The external regenerative resistance value or regenerative resistance capacity is insufficient, or it is in a continuous regeneration state	Again, the operating conditions or capacity are confirmed.	Change the regeneration resistance value and regenerative resistance capacity. Adjust the operating conditions again.
Continuously bear negative loads and are in a state of continuous regeneration	Confirm the load applied to the motor in operation.	Revisiting the system, which includes servo, mechanical, and operating conditions.
The capacity set in Pn536 (discharge resistor power) is less than the capacity of the external regenerative resistor	Confirm the connection of the regenerative resistor and the value of Pn536.	Corrects the setpoint of Pn536.

Possible causes	Confirm the method	Action
The value set in Pn535 (Discharge Resistor Resistance) is less than the external regenerative resistance value	Confirm the connection of the regenerative resistor and the value of Pn535.	Corrects the setpoint of Pn535.
The external regeneration resistance value is too large	Confirm that the regeneration resistance value is correct.	Change it to the correct resistance value and capacity.
Drive failure	Confermtat Tregnation Rescisteins Valleus Correct.	Replace the drive.

A.1F: Short-to-ground fault

Possible causes	Confirm the method	Action
The motor cable has a short-circuit to ground	Confirm if a short circuit has occurred between the UVW of the cable and the ground.	There is a possibility that the cable will be short-circuited. Replace the cable.
A short-to-ground circuit has occurred inside the drive	Confirm whether a short circuit has occurred between the UVW and the ground of the motor connection terminal of the drive.	It may be a drive failure. Replace the drive.

A.24: The main loop power supply is wired incorrectly

Possible causes	Confirm the method	Action
A single-phase AC power supply input (Pn007.1 = 0) is not set and a single-phase power supply is entered	Confirm power and parameter settings.	Set the correct power inputs and parameters.

A.37: Control panel communication timed out

Possible causes	Confirm the method	Action
Poor connection between the operator panel and the drive	Confirm the contact of the connector.	Reinsert the connector. Or replace the cable.
Malfunction due to noise	Improve the noise environment such as wiring and settings to confirm whether there is any effect.	Keep the operator panel body or cable away from devices/cables that are generating noise interference.

Possible causes	Confirm the method	Action
Operator panel failure	Connect the operator panel again. When an alarm still occurs, it is possible that the operator panel is malfunctioning.	Replace the operator panel.
Drive failure	Power on the drive. When an alert still occurs, it may be a drive failure.	Replace the drive.

A.42: The motor power does not match the drive power

Possible causes	Confirm the method	Action
The drive capacity does not match the capacity of the motor	The drive capacity must be the same as the motor capacity.	Match the capacity of the drive to the motor.
Encoder failure	After replacing the encoder, confirm that the alarm no longer occurs.	Replace the motor (encoder).
Drive failure	Power on the drive. When an alert still occurs, it may be a drive failure.	Replace the drive.

A.43: The encoder type is incorrect

Possible causes	Confirm the method	Action
Encoder failure	After replacing the encoder, confirm that the alarm no longer occurs.	Replace the motor (encoder).
Drive failure	Power on the drive. When an alert still occurs, it may be a drive failure.	Replace the drive.

A.45: Multi-turn data error

Possible causes	Confirm the method	Action
The battery is poorly connected and not connected	Confirm the connection of the battery.	Properly connect the battery.
The battery voltage is below the specified value	Measure the voltage of the battery.	Replace the battery and clear the alarm. See "3.5.3 Installing or Replacing the Battery".
Drive failure	Power on the drive. When an alert still occurs, it may be a drive failure.	Replace the drive.

A.46: Multi-turn data overflow

Possible causes	Confirm the method	Action
The battery is poorly connected and not connected	Confirm the connection of the battery.	Properly connect the battery.
Multiple laps of data have overflowed	-	Set up one of the following: Use the operator panel to perform Fn010 and Fn011. Using ESView V4, go to the "Functions→ Configuration Wizard→ Encoder Settings", then click "Clear Multiturn Messages" and "Clear Multiturn Alarms".

A.47: The absolute encoder battery voltage is too low

Possible causes	Confirm the method	Action
The battery is poorly connected and not connected	Confirm the connection of the battery.	Properly connect the battery.
The battery voltage is below 2.45V	Measure the voltage of the battery.	Replace the battery and clear the alarm. See "3.5.3 Installing or Replacing the Battery".
Drive failure	Power on the drive. When an alert still occurs, it may be a drive failure.	Replace the drive.

A.48: Absolute encoder battery voltage undervoltage

Possible causes	Confirm the method	Action
The battery is poorly connected and not connected	Confirm the connection of the battery.	Properly connect the battery.
The battery voltage is below 3.0V	Measure the voltage of the battery.	Replace the battery and clear the alarm. See "3.5.3 Installing or Replacing the Battery".
Drive failure	Power on the drive. When an alert still occurs, it may be a drive failure.	Replace the drive.

A.49: Multiple or single turn data anomalies were detected

Possible causes	Confirm the method	Action
The battery is poorly connected and not connected	Confirm the connection of the battery.	Properly connect the battery.
The battery voltage is below 3.0V	Measure the voltage of the battery.	Replace the battery and clear the alarm. See "3.5.3 Installing or Replacing the Battery".
Drive failure	Power on the drive. When an alert still occurs, it may be a drive failure.	Replace the drive.

A.50: The encoder is disconnected

Possible causes	Confirm the method	Action
The encoder cable is wired incorrectly	Confirm the wiring of the motor encoder cable.	Confirm that the motor cable or encoder cable has problems such as poor contact.
Malfunction due to noise	Improve the noise environment such as wiring and settings to confirm whether there is any effect.	Adopt anti-interference countermeasures.
Encoder failure	Power on the drive. When an alarm still occurs, it is possible that the motor is malfunctioning.	Replace the motor.
Drive failure	Power on the drive. When an alert still occurs, it may be a drive failure.	Replace the drive.

A.51: Absolute encoder overspeed detection

Possible causes	Confirm the method	Action
When the control power is turned on, the motor rotates at a speed of more than 200 rpm	The speed of the motor is confirmed by the speed of the motor when the power is turned on.	Adjust the motor speed to less than 200 rpm and turn on the control power.
Encoder failure	Power on the drive. When an alarm still occurs, it is possible that the motor or absolute encoder is faulty.	Replace the motor or absolute encoder.
Drive failure	Power on the drive. When an alert still occurs, it may be a drive failure.	Replace the drive.

A.52: An error occurred inside the encoder

Possible causes	Confirm the method	Action
Encoder-related alarms have not been reset	Resets the encoder-related alarms	Set up one of the following: Use the operator panel to perform Fn010 and Fn011. Using ESView V4, go to the "Functions→ Configuration Wizard→ Encoder Settings", then click "Clear Multiturn Messages" and "Clear Multiturn Alarms".

A.53: Error encoder lap information

Possible causes	Confirm the method	Action
Encoder-related alarms have not been reset	Resets the encoder-related alarms	Set up one of the following: Use the operator panel to perform Fn010 and Fn011. Using ESView V4, go to the "Functions→ Configuration Wizard→ Encoder Settings", then click "Clear Multiturn Messages" and "Clear Multiturn Alarms".

A.54: Errors occurred at the check digits and cutoff bits in the encoder control domain

Possible causes	Confirm the method	Action
Encoder-related alarms have not been reset	Resets the encoder-related alarms	Set up one of the following: Use the operator panel to perform Fn010 and Fn011. Using ESView V4, go to the "Functions→ Configuration Wizard→ Encoder Settings", then click "Clear Multiturn Messages" and "Clear Multiturn Alarms".

A.58: Information such as encoder zone phase is empty or incorrect

Possible causes	Confirm the method	Action
Encoder failure	Power on the drive. When an alarm still occurs, it is possible that the motor or absolute encoder is faulty.	Replace the motor or absolute encoder.

A.59: Information such as the motor body in the second area of the encoder is empty or wrong

Possible causes	Confirm the method	Action
Encoder failure	Power on the drive. When an alarm still occurs, it is possible that the motor or absolute encoder is faulty.	Replace the motor or absolute encoder.

A.65: Location overflow alarm

Possible causes	Confirm the method	Action
The wiring of the motor U, V, W is incorrect	Confirm the wiring of the motor main circuit cable.	Confirm that the motor cable or encoder cable has problems such as poor contact.
Position commands are too fast	Try lowering the position command speed before running.	Lower the position command speed or command acceleration, or adjust the electronic gear ratio.
The position instruction accelerates too much	Try to reduce the acceleration of the command before running.	With the EtherCAT command, the position command acceleration is reduced.
Deviation counter overflow alarm (Pn504) is low relative to operating conditions	Confirm that the position deviation counter overflow alarm (Pn504) is appropriate.	Correctly set the value of the parameter Pn504.
Drive failure	Power on the drive. When an alert still occurs, it may be a drive failure.	Replace the drive.

A.70: DC synchronization error

Possible causes	Confirm the method	Action
Synchronization timing (Sync0) fluctuations in EtherCAT communication.	–	Reboot the drive to re-establish EtherCAT communication.

A.71: SM Event synchronization event premature

Possible causes	Confirm the method	Action
EtherCAT communication error due to noise.	–	Check the EtherCAT wiring and implement noise countermeasures.

Possible causes	Confirm the method	Action
The controller does not update process data during a fixed period of time.	Examine the process data specified by the controller.	Modify the controller's configuration so that it can update process data during a fixed period.
The EtherCAT communication cable or connector wiring is faulty.	Check the EtherCAT communication cables and connector wiring.	Modify the wiring.

A.72: SM Event synchronization event timed out

Possible causes	Confirm the method	Action
EtherCAT communication error due to noise.	–	Check the EtherCAT wiring and implement noise countermeasures.
The controller does not update process data during a fixed period of time.	Examine the process data specified by the controller.	Modify the controller's configuration so that it can update process data during a fixed period.
The EtherCAT communication cable or connector wiring is faulty.	Check the EtherCAT communication cables and connector wiring.	Modify the wiring.

A.73: EtherCAT processor internal error

Possible causes	Confirm the method	Action
Drive failure	Power on the drive. When an alert still occurs, it may be a drive failure.	Replace the drive.

A.74: The position is set in the Cubic interpolation algorithm with a period error

Possible causes	Confirm the method	Action
Synchronization timing (Sync0) fluctuations in EtherCAT communication	–	Reboot the drive to re-establish EtherCAT communication.

A.75: There was an error setting for the synchronization period

Possible causes	Confirm the method	Action
Synchronization timing (Sync0) fluctuations in EtherCAT communication	–	Reboot the drive to re-establish EtherCAT communication.
The setting of object 60C2 is not an integer multiple of 125 μ s	Check the setpoint of object 60C2	Correctly set object 60C2.

A.76: The acceleration object is set to 0 in PP/PV mode

Possible causes	Confirm the method	Action
The setpoints for objects 6083, 6084, 6085 are incorrect	The setpoints for objects 6083, 6084, 6085 (not 0).	Correctly set objects 6083, 6084, 6085.

A.77: OP mode process data watchdog communication timed out

Possible causes	Confirm the method	Action
Detects whether the master controller sends process data properly	The data transmission interval is detected by the wireshark packet capture software	Reboot the drive to re-establish EtherCAT communication.
Whether the network cable is loose	Check whether the network cable is plugged in tightly	Reseat the network cable

A.81: The motor UVW wiring is wrong

Possible causes	Confirm the method	Action
A short circuit or a short circuit to the ground occurs inside the motor	Confirm whether a short circuit has occurred between the UVW phases of the motor terminals and between the UVW and the ground	It is possible that the motor is faulty. Replace the motor.
The U, V, W phase sequence of the motor wiring is incorrect	Confirm the wiring of the motor.	Confirm if there is a problem with the motor wiring.

A.82: The motor type does not match

Possible causes	Confirm the method	Action
The drive capacity does not match the capacity of the motor	The drive capacity must be the same as the motor capacity.	Match the capacity of the drive to the motor.

A.83: The motor is operating abnormally

Possible causes	Confirm the method	Action
A short circuit or a short circuit to the ground occurs inside the motor	Confirm whether a short circuit has occurred between the UVW phases of the motor terminals and between the UVW and the ground.	It is possible that the motor is faulty. Replace the motor.
The U, V, W phase sequence of the motor wiring is incorrect	Confirm the wiring of the motor.	Confirm if there is a problem with the motor wiring.

A.F0: Internal logic exceptions

Possible causes	Confirm the method	Action
Drive failure	Power on the drive. When an alert still occurs, it may be a drive failure.	Replace the drive.

Gr.2 AlarmA.15: The regenerative resistance is damaged

Possible causes	Confirm the method	Action
The drive requires an external braking resistor	Confirm the connection of the external regenerative resistor and check the setpoints of Pn535 and Pn536.	Aft Connell Tinte Externard Brakin Recisto, Setben 535 Anderben 536 Tot Aproprit Valluet.
When an external braking resistor is not used, the short wiring of B2 and B3 falls off	Confirm the connection of the short wires of B2 and B3.	Properly wire the short wiring.
External regenerative resistors are poorly wired, detached, or disconnected	Confirm the wiring of the external regenerative resistor.	Properly wired external regenerative resistors.

Possible causes	Confirm the method	Action
Drive failure	Power on the drive. When an alert still occurs, it may be a drive failure.	Replace the drive.

A.1A: The charging resistance is overloaded

Possible causes	Confirm the method	Action
The input power supply is unstable	Measure and confirm the status of the input power supply.	Ensure that the input power supply is stable.
Power is turned on and off too frequently	–	Extend the interval between power on and off or reduce the frequency of power on and off.

A.1B: The DB braking circuit is damaged

Possible causes	Confirm the method	Action
The motor is driven by an external force	Confirm the health status.	Do not drive the motor by external force.
The rotational or running energy at the time the DB is stopped exceeds the capacity of the DB resistance	The DB usage frequency is confirmed by the DB resistor power dissipation.	Try the following measures. Reduce the command speed of the motor. Adjust the moment of inertia or mass ratio. Reduce the number of DB stops.
Drive failure	Power on the drive. When an alert still occurs, it may be a drive failure.	Replace the drive.

A.20: The main loop power line is out of phase

Possible causes	Confirm the method	Action
Poor wiring of three-phase wires	Confirm the power wiring.	Confirm if there is a problem with the power wiring.
The three-phase power supply is unbalanced	Measure the voltage of each phase of a three-phase power supply.	Corrects the imbalance of the power supply (reversing phase).
A single-phase AC power supply input (Pn007.1 = 0) is not set and a single-phase power supply is entered	Confirm power and parameter settings.	Set the correct power inputs and parameters.

Possible causes	Confirm the method	Action
Drive failure	Power on the drive. When an alert still occurs, it may be a drive failure.	Replace the drive.

A.33: USB Power Supply Exceptions

Cause	Way of confirmation	Solution
USB cable is damaged	Confirm USB cable	Replace the USB drive
Drive failure	If the alarm still occurs when the USB cable is replaced, the drive may be faulty	Replace the drive

A.49: Multi-turn or Single-turn Data Exception Detected

Cause	Way of confirmation	Solution
Poor battery connection, or not connected	Confirm battery installation	Install the battery correctly
Battery voltage below 3.0V	Measure the battery voltage	<ul style="list-style-type: none"> Replace the battery and clear the alarm. See “3.5.3 Installing or Replacing the Battery”.
Drive failure	Re-apply power to the drive. If the alarm still occurs, the drive may be faulty.	Replace the drive.

A.4A: Excessive Encoder Temperature

Cause	Way of confirmation	Solution
High ambient temperature of the motor	Measure the ambient temperature of the motor.	Adjust the ambient temperature of the motor to below 40°C.
Motor running at a load in excess of the rated value	Confirm load by cumulative load factor.	Adjust the load of the motor before running to a value within the rated value.
Encoder failure	Re-apply power to the drive. If the alarm still occurs, it is possible that the motor or absolute encoder is faulty.	Replace the motor or absolute encoder.
Drive failure	Re-apply power to the drive. If the alarm still occurs, the drive may be faulty.	Replace the drive.

10.2.3 Warnings

A.1C: Fan Disconnection Alarm

Cause	Way of confirmation	Solution
Fan is disconnected	Confirm if the fan is working	Confirm if the internal fan is wired correctly
Fan is damaged	Fan does not work even after correct wiring	Replace the drive

A.33: USB Power Supply Exceptions

Cause	Way of confirmation	Solution
USB cable is damaged	Confirm USB cable	Replace the USB drive
Drive failure	If the alarm still occurs when the USB cable is replaced, the drive may be faulty	Replace the drive

A.49: Multi-turn or Single-turn Data Exception Detected

Cause	Way of confirmation	Solution
Poor battery connection, or not connected	Confirm battery installation	Install the battery correctly
Battery voltage below 3.0V	Measure the battery voltage	<ul style="list-style-type: none"> Replace the battery and clear the alarm. See “3.5.3 Installing or Replacing the Battery”.
Drive failure	Re-apply power to the drive. If the alarm still occurs, the drive may be faulty.	Replace the drive.

A.4B: Absolute Encoder Battery Undervoltage (Tamagawa)

Cause	Way of confirmation	Solution
Poor battery connection, or not connected	Confirm battery installation	Install the battery correctly
Battery voltage below 3.0V	Measure the battery voltage	Replace the battery and clear the alarm. See “3.5.3 Installing or Replacing the Battery”.
Drive failure	Re-apply power to the drive. If the alarm still occurs, the drive may be faulty.	Replace the drive.

A.D5: Fan Disconnection Warning

Cause	Way of confirmation	Solution
Poor fan wiring	Confirm if the fan is working	Confirm if the internal fan is wired correctly

A.D7: Warning for Reaching Soft Limit Positive Limit

Cause	Way of confirmation	Solution
The current position of the motor is outside the limits in this mode	Compare the current motor position Un009 with the position limits (Pn325,Pn325) to determine if the limits are exceeded	Enabling servo into the limits

A.D8: Warning for Reaching Soft Limit Reverse Limit

Cause	Way of confirmation	Solution
The current position of the motor is outside the limits in PCP mode	Compare the current motor position Un009 with the position limits (Pn325,Pn325) to determine if the limits are exceeded	Enabling servo into the limits

A.D9: Origin Error Warning

Cause	Way of confirmation	Solution
Loss of stored origin	Confirm if the origin values stored in Un035 and Un036 are correct	<ol style="list-style-type: none"> 1. When Pn689.2 = 1, switch on the Storing Origin function 2. Use multiturn encoder. 3. When Pn002.2=1, use the multiturn encoder as absolute

Chapter 11 Parameters

11.1 Interpreting the Parameter Lists

"When Enabled" indicates the parameter take effective when:
 [After restart] the power supply is turned OFF and ON again.
 [Immediately] it was set.

No.	Name	Range	Unit	Default	When Enabled																				
	Basic Function Selections 0	0000 to 0111	-	0000	After restart																				
Pn000	<div style="border: 1px solid red; padding: 5px; display: inline-block; margin-bottom: 5px;"> 60000 </div> <table border="1" style="width: 100%; border-collapse: collapse;"> <tr> <td colspan="2" style="background-color: #e6f2ff;">Pn000.0: Servo ON</td> </tr> <tr> <td style="text-align: center;">0</td> <td>Enabled.</td> </tr> <tr> <td style="text-align: center;">1</td> <td>Disabled. When turn the S-RDY signal ON, the motor is excitation automatically.</td> </tr> <tr> <td colspan="2" style="background-color: #e6f2ff;">Pn000.1: Forward Drive Prohibit Input</td> </tr> <tr> <td style="text-align: center;">0</td> <td>Enabled. The motor is stopped according to the setting of Pn003.1 when the overtravel occurs.</td> </tr> <tr> <td style="text-align: center;">1</td> <td>Disabled.</td> </tr> <tr> <td colspan="2" style="background-color: #e6f2ff;">Pn000.2: Reverse Drive Prohibit Input</td> </tr> <tr> <td style="text-align: center;">0</td> <td>Enabled. The motor is stopped according to the setting of Pn003.1 when the overtravel occurs.</td> </tr> <tr> <td style="text-align: center;">1</td> <td>Disabled.</td> </tr> <tr> <td colspan="2" style="background-color: #e6f2ff;">Pn000.3: Reserved setting (Do not change).</td> </tr> </table>	Pn000.0: Servo ON		0	Enabled.	1	Disabled. When turn the S-RDY signal ON, the motor is excitation automatically.	Pn000.1: Forward Drive Prohibit Input		0	Enabled. The motor is stopped according to the setting of Pn003.1 when the overtravel occurs.	1	Disabled.	Pn000.2: Reverse Drive Prohibit Input		0	Enabled. The motor is stopped according to the setting of Pn003.1 when the overtravel occurs.	1	Disabled.	Pn000.3: Reserved setting (Do not change).					
Pn000.0: Servo ON																									
0	Enabled.																								
1	Disabled. When turn the S-RDY signal ON, the motor is excitation automatically.																								
Pn000.1: Forward Drive Prohibit Input																									
0	Enabled. The motor is stopped according to the setting of Pn003.1 when the overtravel occurs.																								
1	Disabled.																								
Pn000.2: Reverse Drive Prohibit Input																									
0	Enabled. The motor is stopped according to the setting of Pn003.1 when the overtravel occurs.																								
1	Disabled.																								
Pn000.3: Reserved setting (Do not change).																									

Parameter Number

Here lists the value of the parameter and their description

11.2 Parameters Detailed

No.	Index	Name	Range	Unit	Default
	Basic Function Selections 0	b0000 to b0111	–	b0000	After restart
Pn000					
	Pn000.0: Servo ON				
	0	External S-ON Enabled.			
	1	External S-ON disabled. Servo motor excitation signal is turned ON automatically after S/RDY is output.			
	Pn000.1: Forward Drive Prohibit Input				
	0	External P-OT enabled. Operate in the time sequence setting in Pn004.0 when travel limit occurs.			
	1	External P-OT Disabled.			
	Pn000.2: Reverse Drive Prohibit Input				
	0	External N-OT enabled. Operate in the time sequence setting in Pn004.0 when travel limit occurs.			
	1	Disabled.			
Pn000.3: Reserved setting (Do not change).					

No.	Index	Name	Range	Unit	Default
	Reserved setting (Do not change).	b0000 to b1111	–	b0000	After restart
Pn001					
	Pn001.0: Motor Running Direction Selection				
	0	CCW, counter-clockwise rotation in the positive direction			
	1	CW, clockwise rotation in the positive direction			
	Pn001.1: Analog Speed Limit Enabled				
	0	Sets the value of Pn406 as the speed limit value during torque control.			
	1	Use the smaller of the speed value corresponding to the analog voltage input by Tref and the set value of Pn406 as the speed limit value during torque control.			
	Pn001.2: Analog Torque Limit Enabled				
	0	Sets Pn401–Pn404 as torque limit.			
	1	Sets the value corresponding to Tref input analog voltage as torque limit.			
	Pn001.3: 2nd Electronic Gear Enabled				
	0	2nd electronic gear is disabled, PCON signal is used to switch P/PI			
	1	2nd electronic gear is enabled, PCON signal is only used as 2nd electronic gear.			

No.	Index	Name	Range	Unit	Default
	Application Function Selections 2	b0000 to b0100	–	b0000	After restart
Pn002					
	Pn002.0: Reserved setting (Do not change).				
	Pn002.1: Selection of Alarm Mechanism for Tamagawa Protocol Encoders				
	0	Alarm A.48 occurs when Tamagawa protocol encoder battery voltage is below 3.0V			
	1	Alarm A.48 occurs when Tamagawa protocol encoder battery voltage is below 3.0V, and Alarm A.4b occurs when the battery voltage is below 3V during normal operation			
Pn002.2: Usage of Absolute Encoder					
0	Use the encoder as an absolute encoder.				
1	Use the encoder as an incremental encoder.				
Pn002.3: Reserved setting (Do not change).					

No.	Index	Name	Range	Unit	Default
	Application Function Selections 3	h0000 to h1032	–	h0000	After restart
Pn003					
	Pn003.0: Motor Stopping Mode In Case of a Gr.1 alarm, STO Active and SOFF				
	0	Applying the dynamic brake and then let the Motor coast.			
	1	DB braking stops and stays DB after stop			
	2	Stops freely and remains free after stopping			
	Pn003.1: Motor Stopping Method for Overtravel				
	0	DB brake stops, and remains free after stopping			
	1	Stops freely and remains free after stopping			
	2	Reverse braking stops, and maintains zero clamp after stop			
	3	Reverse braking stops, and remains free after stop			
	Pn003.2: Reserved setting (Do not change).				
	Pn003.3: Overload Enhancement				
	0	Disabled.			
	1	Enabled. This function can enhance the Motor load for instantaneous more than 2 times rated load, which can be used in the conditions that require frequent start and stop.			

No.	Index	Name	Range	Unit	Default														
	Application Function Selections 4	h0000 to h3425	–	h0000	After restart														
Pn004																			
	<table border="1"> <thead> <tr> <th colspan="2">Pn004.0: Servo OFF and Stop Mode When Overtravel</th> </tr> </thead> <tbody> <tr> <td>0</td> <td>Motor stopped by dynamic brake. After the motor stopped, the motor will be free;</td> </tr> <tr> <td>1</td> <td>Motor is running freely until it stops.</td> </tr> <tr> <td>2</td> <td>Servo OFF: motor stopped by dynamic brake. When overtravel occurs: Reverse braking stops.</td> </tr> <tr> <td>3</td> <td>Servo OFF: motor is running freely until it stops. When overtravel occurs: Reverse braking stops.</td> </tr> <tr> <td>4</td> <td>Servo OFF: dynamic brake stopped. When overtravel occurs: Reverse braking stops and the motor enters the zero clamp state.</td> </tr> <tr> <td>5</td> <td>Regards it as the Warning, and the Motor will run properly.</td> </tr> </tbody> </table>					Pn004.0: Servo OFF and Stop Mode When Overtravel		0	Motor stopped by dynamic brake. After the motor stopped, the motor will be free;	1	Motor is running freely until it stops.	2	Servo OFF: motor stopped by dynamic brake. When overtravel occurs: Reverse braking stops.	3	Servo OFF: motor is running freely until it stops. When overtravel occurs: Reverse braking stops.	4	Servo OFF: dynamic brake stopped. When overtravel occurs: Reverse braking stops and the motor enters the zero clamp state.	5	Regards it as the Warning, and the Motor will run properly.
	Pn004.0: Servo OFF and Stop Mode When Overtravel																		
	0	Motor stopped by dynamic brake. After the motor stopped, the motor will be free;																	
	1	Motor is running freely until it stops.																	
	2	Servo OFF: motor stopped by dynamic brake. When overtravel occurs: Reverse braking stops.																	
	3	Servo OFF: motor is running freely until it stops. When overtravel occurs: Reverse braking stops.																	
	4	Servo OFF: dynamic brake stopped. When overtravel occurs: Reverse braking stops and the motor enters the zero clamp state.																	
	5	Regards it as the Warning, and the Motor will run properly.																	
	<table border="1"> <thead> <tr> <th colspan="2">Pn004.1: Deviation Counter Clear in Local Control Mode</th> </tr> </thead> <tbody> <tr> <td>0</td> <td>Reset to zero when Servo is OFF or STO is available.</td> </tr> <tr> <td>1</td> <td>Reserved setting (Do not change).</td> </tr> <tr> <td>2</td> <td>Reset to zero when Servo is OFF, or STO is available, or Overtravel is occurred.</td> </tr> </tbody> </table>					Pn004.1: Deviation Counter Clear in Local Control Mode		0	Reset to zero when Servo is OFF or STO is available.	1	Reserved setting (Do not change).	2	Reset to zero when Servo is OFF, or STO is available, or Overtravel is occurred.						
	Pn004.1: Deviation Counter Clear in Local Control Mode																		
	0	Reset to zero when Servo is OFF or STO is available.																	
	1	Reserved setting (Do not change).																	
	2	Reset to zero when Servo is OFF, or STO is available, or Overtravel is occurred.																	
	<table border="1"> <thead> <tr> <th colspan="2">Pn004.2: Reference pulse form</th> </tr> </thead> <tbody> <tr> <td>0</td> <td>SIGN + PULS</td> </tr> <tr> <td>1</td> <td>CW + CCW</td> </tr> <tr> <td>2</td> <td>A + B (×1)</td> </tr> <tr> <td>3</td> <td>A + B (×2)</td> </tr> <tr> <td>4</td> <td>A + B (×4)</td> </tr> </tbody> </table>					Pn004.2: Reference pulse form		0	SIGN + PULS	1	CW + CCW	2	A + B (×1)	3	A + B (×2)	4	A + B (×4)		
	Pn004.2: Reference pulse form																		
	0	SIGN + PULS																	
	1	CW + CCW																	
	2	A + B (×1)																	
	3	A + B (×2)																	
4	A + B (×4)																		
<table border="1"> <thead> <tr> <th colspan="2">Pn004.3: Inverses pulse</th> </tr> </thead> <tbody> <tr> <td>0</td> <td>Do not inverse PULS reference and SIGN reference.</td> </tr> <tr> <td>1</td> <td>Do not inverse PULS reference; Inverses SIGN reference.</td> </tr> <tr> <td>2</td> <td>Inverse PULS reference; Do not inverse SIGN reference.</td> </tr> <tr> <td>3</td> <td>Inverse PULS reference and SIGN reference.</td> </tr> </tbody> </table>					Pn004.3: Inverses pulse		0	Do not inverse PULS reference and SIGN reference.	1	Do not inverse PULS reference; Inverses SIGN reference.	2	Inverse PULS reference; Do not inverse SIGN reference.	3	Inverse PULS reference and SIGN reference.					
Pn004.3: Inverses pulse																			
0	Do not inverse PULS reference and SIGN reference.																		
1	Do not inverse PULS reference; Inverses SIGN reference.																		
2	Inverse PULS reference; Do not inverse SIGN reference.																		
3	Inverse PULS reference and SIGN reference.																		

No.	Index	Name	Range	Unit	Default
Pn005	Application Function Selections 5	h0000 to h33D3	–	h0010	After restart

DRAFT

Pn005.0: Internal Torque Feedforward Method	
0	Use the general internal torque feedforward.
1	Reserved.
2	Use the high-speed internal torque feedforward.
3	Reserved.



Pn005.1: Local Control Method	
0	Speed control (analog reference): use PI control when PCON is OFF, and use P control when PCON is ON.
1	Position control (pulse train reference): use PI control when PCON is OFF, and use P control when PCON is ON.
2	Torque control: PCON is invalid.
3	Speed control (contact reference) ↔ speed control (zero reference): switch to the speed control (zero reference) when PCON, PCL and NCL are OFF
4	Speed control (contact reference) ↔ speed control (analog reference): switch to the speed control (analog reference) when PCON, PCL and NCL are OFF.
5	Speed control (contact reference) ↔ position control (pulse train reference): switch to the position control (pulse train reference) when the PCON, PCL and NCL signals are OFF.
6	Speed control (contact reference) ↔ Torque control (analog reference): switch to the torque control (analog reference) when the PCON, PCL and NCL signals are OFF.
7	Position control (pulse train reference) ↔ speed control (analog reference): when PCON is OFF, position control (pulse train reference) is valid; when PCON is ON, speed control (analog reference) is valid.
8	Position control (pulse train reference) ↔ Torque control (analog reference): When PCON is OFF, position control (pulse train reference) is valid; when PCON is ON, torque control is valid.
9	Torque control (analog reference) ↔ speed control (analog reference): When PCON is OFF, torque control is valid; when PCON is ON, speed control (analog reference) is valid.
A	Speed control (analog reference) ↔ zero clamp control: When PCON is OFF, speed control (analog reference) is valid; when PCON is ON, zero clamp control is used.
B	Position control (pulse train reference) ↔ Position control (pulse prohibited): When PCON is OFF, position control (pulse train reference) is valid; when PCON is ON, position control (pulse prohibited) is valid.
C	Position control (PCP control)
D	Speed control (parameter reference): PCON is invalid.

Pn005.2: Torque Feedforward Method	
0	Use the internal torque feedforward.
1	Use the model following control torque feedforward, which is available when Model Following Control Selection (Pn150.0) is enabled.
2	Controller setting speed feed-forward: valid in bus control mode, and set by object 0x60B1.
3	Speed feed-forward generated by the Cubic interpolation algorithm: valid after the Cubic interpolation algorithm is selected through the object 0x60C0 in bus control mode.



Pn005.3: Speed Feedforward Method	
0	Use the internal speed feedforward.

No.	Index	Name	Range	Unit	Default						
		1	Use the model following control speed feedforward, which is available when Model Following Control Selection (Pn150.0) is enabled.								
		2	Controller setting speed feed-forward: valid in bus control mode, and set by object 0x60B1.								
		3	Speed feed-forward generated by the Cubic interpolation algorithm: valid after the Cubic interpolation algorithm is selected through the object 0x60C0 in bus control mode.								
	Application Function Selections 6	h0000 to h0001	-	h0000	After restart						
Pn006											
	<table border="1"> <tr> <th colspan="2">Pn006.0: Bus Selection</th> </tr> <tr> <td>0</td> <td>Non-bus, set the control mode via Pn005.1</td> </tr> <tr> <td>1</td> <td>CANOpen</td> </tr> </table>					Pn006.0: Bus Selection		0	Non-bus, set the control mode via Pn005.1	1	CANOpen
	Pn006.0: Bus Selection										
	0	Non-bus, set the control mode via Pn005.1									
	1	CANOpen									
Pn006.1: Reserved setting (Do not change).											
Pn006.2: Reserved setting (Do not change).											
Pn006.3: Reserved setting (Do not change).											

No.	Index	Name	Range	Unit	Default
Pn007	Application Function Selections 7	h0000 to h1120	–	h0000	After restart
					
	Pn007.0: Reserved setting (Do not change).				
	Pn007.1: Power Supply Selection				
	0	Single-phase AC			
	1	Three-phase AC			
	2	DC			
	Pn007.2: Torque Limit Action When Undervoltage Occurs				
	0	Disabled.			
	1	Enabled.			
Pn007.3: AC Supply Frequency					
0	50Hz				
1	60Hz				
Pn008	Initial Display Selection When Power On	0 to 9999	–	9999	After restart
	Set the displayed Un Number when power on the device. For example, set this parameter to 0, the display is Un000 after powering on the device.				

No.	Index	Name	Range	Unit	Default						
Pn009	Application Function Selections 9	h0000 to h0001	-	h0000	After restart						
											
	<table border="1"> <tr> <td colspan="2">Pn009.0: Shared DC Bus Function</td> </tr> <tr> <td>0</td> <td>Disabled.</td> </tr> <tr> <td>1</td> <td>Enabled.</td> </tr> </table>					Pn009.0: Shared DC Bus Function		0	Disabled.	1	Enabled.
	Pn009.0: Shared DC Bus Function										
	0	Disabled.									
1	Enabled.										
Pn009.1: Reserved setting (Do not change).											
Pn009.2: Reserved setting (Do not change).											
Pn009.3: Reserved setting (Do not change).											
Pn010	Application Function Setting 10	h0000 ~ h0001	0000	-	After restart						
											
	<table border="1"> <tr> <td colspan="2">Pn010.0: Gantry Synchro Function</td> </tr> <tr> <td>0</td> <td>Disabled Gantry Synchro function</td> </tr> <tr> <td>1</td> <td>Enabled Gantry Synchro function</td> </tr> </table>					Pn010.0: Gantry Synchro Function		0	Disabled Gantry Synchro function	1	Enabled Gantry Synchro function
	Pn010.0: Gantry Synchro Function										
	0	Disabled Gantry Synchro function									
1	Enabled Gantry Synchro function										
Pn010.1: Reserved											
Pn010.2: Reserved											
Pn010.3: Reserved											

No.	Index	Name	Range	Unit	Default				
Pn011	Application Function Setting 11	0000 ~ 0001	0000	—	After restart				
	<p>Pn011.0: Gantry Synchro Homing Done Sign</p> <table border="1"> <tr> <td>0</td> <td>Homing not done</td> </tr> <tr> <td>1</td> <td>Homing done</td> </tr> </table> <p>Pn010.1: Reserved</p> <p>Pn011.2: Reserved</p> <p>Pn011.3: Reserved</p>					0	Homing not done	1	Homing done
0	Homing not done								
1	Homing done								
Pn012	Open Threshold of Synchronous Adjustment	0 ~ 10000	pulse	0	After restart				
	—								
Pn013	Alarm Threshold for Excessive Position Error	0 ~ 65535	pulse	10000	After restart				
	—								

No.	Index	Name	Range	Unit	Default
Pn014	Application Function Setting 14	h0000 ~ h0010	–	h0000	After restart
					
	Pn014.0: Reserved				
	Pn014.1: PCP Control IO Trigger Mode				
	0	Edge			
1	Level				
Pn014.2: PCP Control Contact 0 Trigger Invalid					
0	Contact 0 can be triggered				
1	Contact 0 cannot be triggered				
Pn014.3: Reserved					
Pn015	Application Function Setting 15	h0000 ~ h0001	0000	–	After restart
					
Pn015.0: Soft Limit Enable Position Valid under the PCP function					
1	Non-enabling the soft-limit function				
2	Enabling the soft limit function				
Pn015.1: Reserved					
Pn015.2: Auto Vibration Suppression Selection					
Pn015.3: Auto-tuning Type Selection (valid when Pn100.0 = 3)					
Pn100	Application Function Setting 100	h0001 ~ h1105	–	h0001	After restart

No.	Index	Name	Range	Unit	Default
					
		Pn100.0: Parametric Tuning Mode Selection			
	1	Turning not required			
	2	Reserved			
	3	Single parameter auto-tuning (requires setting the correct percentage of load inertia Pn106)			
	4	Reserved			
	5	Manual tuning (requires setting the correct percentage of load inertia Pn106)			
		Pn100.1: Reserved			
		Pn100.2: Auto Vibration Suppression Selection			
	0	Not used			
	1	used			
		Pn100.3: Auto-tuning Type Selection (valid when Pn100.0 = 3)			
	0	Standard: short positioning time, but prone to overshoot			
	1	Stable: smooth positioning, but long positioning times			
Pn101	Servo Rigidity Setting	0 ~ 500	Hz	40	Immediately
	This parameter determines the response characteristic of the servo system. The performance can be improved by increasing this value, and decrease if vibration occurs.				
Pn102	Speed Loop Gain	1 to 10000	rad/s	500	Immediately
	This parameter determines the bandwidth of the speed loop.				
Pn103	Speed Loop Integral Time	1 to 5000	0.1ms	125	Immediately
	Reduce this value can shorten positioning time and speed response time.				
Pn104	Position Loop Gain	0 to 1000	1/s	40	Immediately
	This parameter determines the bandwidth of position loop. Increase this value can improve the stiffness of positioning, decrease if the system vibrates.				

No.	Index	Name	Range	Unit	Default
Pn105	Torque Reference Filter Time	0 to 2500	50	0.01ms	Immediately
	This parameter determines the bandwidth of torque reference filter, the filter is used to filter out the noise in torque reference.				
Pn106	Load Inertia Percentage	0 to 9999	%	0	Immediately
	This value should be set to the percentage of load inertia and Motor inertia.				
Pn107	Second Speed Loop Gain	1 to 10000	rad/s	250	Immediately
	-				
Pn108	Second Speed Loop Integral Time	1 to 5000	rad/s	200	Immediately
	-				
Pn109	Second Position Loop Gain	0 to 1000	1/s	40	Immediately
	-				
Pn110	Second Torque Reference Filter Time	0 to 2500	0.01ms	100	Immediately
	-				
Pn112	Speed Feedforward	0 to 100	%	0	Immediately
	This value is a percentage of the internal speed feedforward. This value is available when the internal speed feedforward is selected (Pn005.3=0).				
Pn113	Speed Feedforward Filter Time	0 to 640	0.1ms	0	Immediately
	This parameter determines the bandwidth of internal speed feedforward filter. The filter is used to filter out the noise in internal speed feedforward.				
Pn114	Torque Feedforward	0 to 100	%	0	Immediately
	This value is a percentage of the internal torque feedforward. This value is available when the internal torque feedforward is selected (Pn005.2=0).				
Pn115	Torque Feedforward Filter Time	0 to 640	0.1ms	0	Immediately
	This parameter determines the bandwidth of internal torque feedforward filter. The filter is used to filter out the noise in internal torque feedforward.				

No.	Index	Name	Range	Unit	Default
Pn116	P/PI Switch Mode	0 to 4	–	0	After restart
	[0] Use torque reference as the condition (threshold setting: Pn117). [1] Use position deviation counter as the condition (threshold setting: Pn118). [2] Use acceleration reference as the condition (threshold setting: Pn119). [3] Use the speed reference as the condition (threshold setting: Pn120). [4] Fixed to PI Control.				
Pn117	Torque Reference Threshold for P/PI Switch	0 to 300	%	200	Immediately
	The threshold is used to switch speed controller from PI to P. This value is a percentage of torque reference.				
Pn118	Deviation Counter Threshold for P/PI Switch	0 to 10000	pulse	0	Immediately
	The threshold is used to switch speed controller from PI to P. This value is a pulse number.				
Pn119	Acceleration Reference Threshold for P/PI Switch	0 to 3000	10rpm/s	0	Immediately
	The threshold is used to switch speed controller from PI to P. This value is an acceleration reference.				
Pn120	Speed Reference Threshold for P/PI Switch	0 to 10000	rpm	0	Immediately
	The threshold is used to switch speed controller from PI to P. This value is a speed reference.				
Pn121	Gain Switch Mode	0 to 10	–	0	After restart
	[0] Fixed to first group gains. [1] Use external signal (G-SEL) as the condition. [2] Use torque reference as the condition (threshold setting: Pn117). [3] Use position deviation counter as the condition (threshold setting: Pn118). [4] Use acceleration as the condition (threshold setting: Pn119). [5] Use speed reference as the condition (threshold setting: Pn120). [6] Use position reference as the condition (threshold setting: Pn123). [7] Use actual speed as the condition (threshold setting: Pn124). [8] Use position reference (Pn123) and actual speed (Pn124) as the condition. [9] Fixed to second group gains. [10] Use positioning completed flag as the condition.				
Pn122	Delay Time for Gain Switch	0 to 20000	0.1 ms	0	Immediately
	The delay time for gain switching after the condition has satisfied.				

No.	Index	Name	Range	Unit	Default
Pn123	Threshold for Gain Switch	0 to 20000	–	0	Immediately
	The threshold of speed reference for gain switching.				
Pn124	Speed Threshold for Gain Switch	0 to 2000	rpm	0	Immediately
	This parameter is available only when using position reference and actual speed as the condition (Pn121=8).				
Pn125	Ramp Time for Position Loop Gain Switch	0 to 20000	0.1 ms	0	Immediately
	Ramp time for gain switching, it is only available to position loop gain.				
Pn126	Hysteresis for Gain Switch	0 to 20000	–	0	Immediately
	Hysteresis of gain switching conditions. It is used to prevent gain switching frequently.				
Pn127	Low Speed Filter	0 to 100	1 cycle	0	Immediately
	This parameter determines the performance of the filter for low speed measurement. The filter will filter out the noise in low speed, but the measured speed has significant delay if this value is large.				
Pn130	Coulomb Friction Compensation	0 to 3000	0.1%Tn	0	Immediately
	This parameter is used to compensate coulomb friction. The value is the permillage of coulomb friction and Motor rated torque.				
Pn131	Speed Dead Band for Coulomb Friction Compensation	0 to 100	rpm	0	Immediately
	To set a dead band to disable coulomb friction compensation. It is used to prevent vibration at zero speed.				
Pn132	Viscous Friction Compensation	0 to 1000	0.1%Tn / 1000rpm	0	Immediately
	Sticking damp which is in direct proportion to speed.				
Pn135	Encoder Speed Filter Time	0 to 30000	0.01 ms	4	Immediately
	To set a proper time for smoothing the changes in the feedback speed to reduce vibration. This parameter is available when the instantaneous speed is not used as the speed feedback (Pn162=0).				

No.	Index	Name	Range	Unit	Default								
Pn136	Tuning-free Rigidity	0-500	50	Hz	Immediately								
	To set the servo rigidity in tuning-free mode												
Pn137	Tuning-free Disturbance Observer bandwidth	0-1000	90	Hz	Immediately								
	To set the scale factor of the disturbance observer in tuning-free mode												
Pn138	Percentage of Tuning-free Disturbance Compensation	0-100	100	%	Immediately								
	To set the scale factor of the disturbance observer in tuning-free mode												
Pn139	Tuning-free Load Inertia %	0-9999	250	%	Immediately								
	To set the percentage of load inertia in the no-tuning mode												
Pn140	Tuning-free Torque Filtering Time Constants	0-2500	100	0.01ms	Immediately								
	To set the torque filter time constant in tuning-free mode												
Pn150	Application Function Setting 150	h0000 - h0002	-	h0000	After restart								
													
	<table border="1" style="width: 100%; border-collapse: collapse;"> <thead> <tr> <th colspan="2">Pn150.0: Model Following Control Selection</th> </tr> </thead> <tbody> <tr> <td style="text-align: center;">0</td> <td>Do not use.</td> </tr> <tr> <td style="text-align: center;">1</td> <td>Use the model following control.</td> </tr> <tr> <td style="text-align: center;">2</td> <td>Use the model following control and load oscillation suppression.</td> </tr> </tbody> </table>					Pn150.0: Model Following Control Selection		0	Do not use.	1	Use the model following control.	2	Use the model following control and load oscillation suppression.
	Pn150.0: Model Following Control Selection												
	0	Do not use.											
	1	Use the model following control.											
2	Use the model following control and load oscillation suppression.												
Pn150.1: Reserved setting (Do not change).													
Pn150.2: Reserved setting (Do not change).													
Pn150.3: Reserved setting (Do not change).													
Pn151	Model Following Control Gain	10 to 1000	1/s	50	Immediately								
	This parameter determines the response characteristic of the servo system. If you increase the setting of the model following control gain, the response characteristic will improve and the positioning time will be shortened.												

No.	Index	Name	Range	Unit	Default
Pn152	Model Following Control Gain Correction	20 to 500	%	100	Immediately
	This parameter is used for correcting the setting of the model following control gain.				
Pn153	Model Following Control Speed Feedforward	0 to 200	%	100	Immediately
	This parameter is used for fine tuning the speed feedforward value output by the model following control gain. If you increase this setting, the bias can be reduced but overshooting will be likely to occur.				
Pn154	Model Following Control Torque Feedforward	0 to 200	%	100	Immediately
	This parameter is used for fine-tuning the torque feedforward value output by the model following control gain. If you increase this setting, the response characteristic can be improved but overshooting will be likely to occur.				
Pn155	Load Oscillation Frequency	50 to 500	0.1Hz	100	Immediately
	In general, this setting is the anti-resonance frequency of the two-mass servo system.				
Pn156	Filter Time for Load Oscillation Suppression	2 to 500	0.1ms	10	Immediately
	If you increase this setting, the response characteristic can be softer but the effect of vibration suppression will be worse.				
Pn157	Limit for Load Oscillation Suppression	0 to 1000	rpm	100	Immediately
	To set a compensation limiting for the jitter suppression at speed feedforward. If you decrease this setting, the response characteristic can be softer but the effect of vibration suppression will be worse.				
Pn160	Load Torque Compensation	0 to 100	%	0	Immediately
	This parameter is a coefficient (percentage) to compensate load torque. Increase this value can improve load disturbance rejection performance but may cause vibration.				
Pn161	Load Torque Observer Gain	0 to 1000	Hz	200	Immediately
	This parameter is used to adjust the response characteristic of the load observer.				
Pn162	Feedback Speed Selection	0 to 1	–	0	After restart
	[0] Use encoder speed as the feedback speed. [1] Use observed speed as the feedback speed.				

No.	Index	Name	Range	Unit	Default
Pn164	Turns for PJOG0	-50 to 50	rotation	5	Immediately
	–				
Pn165	Max Speed for PJOG0	100 to 3000	rpm	1000	Immediately
	–				
Pn166	Acc./Dec. Time for PJOG0	50 to 2000	ms	500	Immediately
	–				
Pn167	Stop Time for PJOG0	100 to 10000	ms	1000	Immediately
	–				
Pn168	Turns for PJOG1	-50 to 50	rotation	-5	Immediately
	–				
Pn169	Max Speed for PJOG1	100 to 3000	rpm	1000	Immediately
	–				
Pn170	Acc./Dec. Time for PJOG1	50 to 2000	ms	500	Immediately
	–				
Pn171	Stop Time for PJOG1	100 to 10000	ms	1000	Immediately
	–				
Pn172	Turns for Inertia Identification	0 to 1	–	0	Immediately
	The number of turns the motor runs in the positive direction when offline inertia is identified [0] 8 rotations. [1] 4 rotations.				
Pn173	Frequency of Vibration Suppression Filter	100 to 2000	Hz	2000	Immediately
	–				
Pn174	Adjust Bandwidth of Vibration Suppression Filter	1 to 100	–	30	Immediately
	–				
Pn175	Vibration Suppression	0 to 500	–	100	Immediately
	–				

No.	Index	Name	Range	Unit	Default
Pn176	Lowpass Filter Time for Vibration Suppression	0 to 50	0.1ms	0	Immediately
	–				
Pn177	Highpass Filter Time for Vibration Suppression	0 to 1000	0.1ms	1000	Immediately
	–				
Pn178	Damping of Vibration Suppression Filter	0 to 500	–	100	Immediately
	–				
Pn179	Amplitude Threshold for Vibration Detection	5 to 500	–	100	Immediately
	This parameter is used for automatic vibration suppression.				
Pn180	Frequency Threshold for Vibration Detection	0 to 100	Hz	100	Immediately
	This parameter is used for automatic vibration suppression.				
Pn181	Frequency of Notch Filter 1	50 to 5000	Hz	5000	Immediately
	–				
Pn182	Depth of Notch Filter 1	0 to 23	–	0	Immediately
	–				
Pn183	Width of Notch Filter 1	0 to 15	–	2	Immediately
	–				
Pn184	Frequency of Notch Filter 2	50 to 5000	Hz	5000	Immediately
	–				
Pn185	Depth of Notch Filter 2	0 to 23	–	0	Immediately
	–				
Pn186	Width of Notch Filter 2	0 to 15	–	2	Immediately
	–				

No.	Index	Name	Range	Unit	Default
Pn187	Frequency of Notch Filter 3	50 to 5000	Hz	5000	Immediately
	–				
Pn188	Depth of Notch Filter 3	0 to 23	–	0	Immediately
	–				
Pn189	Width of Notch Filter 3	0 to 15	–	2	Immediately
	–				
Pn190	Auto Vibration Suppression Status	0 ~ F	–	0	Immediately
	–				
Pn191	Auto Vibration Suppression Amplitude	0 ~ 1000	–	0	Immediately
	–				
Pn200	PG Divided Ratio	16 to 16384	pulse	16384	After restart
	Analog encoder output orthogonal difference pulses. The meaning of this value is the number of analog encoder output orthogonal difference pulses per one motor rotation.				
Pn201	16-bit 1st Electronic Gear Numerator	1 to 100000	–	1	After restart
	<p>The 16-bit electronic gear parameters are valid when Pn009.2=0.</p> <p>The electronic gear enables the reference pulse to relate with the Servo motor travel distance, so the host controller doesn't change the mechanical deceleration ratio and encoder pulses. In fact, it is the setting of frequency doubling or frequency division to the reference pulses.</p>				
Pn202	16-bit 1st Electronic Gear Denominator	1 to 100000	–	1	After restart
	<p>When setting Pn009.2 to 0, it is valid when the 16-bit electronic gear parameter is selected.</p> <p>The use of the electronic gear allows the command pulses to correspond to the amount of motor movement so that the upper unit does not have to pay attention to the mechanical reduction ratio and the number of encoder pulses, which is essentially a setting for multiplying or dividing the command pulses.</p>				
Pn203	16-bit 2 nd Electronic Gear Numerator	1 to 100000	–	1	After restart
	<p>When setting Pn009.2 to 0, it is valid when the 16-bit electronic gear parameter is selected.</p> <p>The use of the electronic gear allows the command pulses to correspond to the amount of motor movement so that the upper unit does not have to pay attention to the mechanical reduction ratio and the number of encoder pulses, which is essentially a setting for multiplying or dividing the command pulses.</p>				

No.	Index	Name	Range	Unit	Default
Pn204	Position Reference Filter Time Constant	0 to 32767	0.1 ms	0	Immediately
	This value is used to smooth the input pulses. The effect of smoothness is better when the value is higher, but lag will occur if the value is too large.				
Pn205	Position Reference Filter Form Constant	0 to 1	–	0	After restart
	<ul style="list-style-type: none"> • 0: 1st order filter • 1: 2nd order filter 				
Pn207	Locked-rotor Torque during Homing	10 to 300	%	100	Immediately
	The value limits the torque during homing mode; Unit: % rated torque.				
Pn208	Locked-rotor Torque Time during Homing	4 to 30000	0.1 ms	4	Immediately
	The allowed time for the stalled during homing mode. Unit : 0.1ms				

No.	Index	Name	Range	Unit	Default	
Pn210						
			Pn210.0: 2nd Encoder Enabling Bit			
			0	Not use the 2 nd encoder		
			1	Use the 2 nd encoder		
			Pn210.1: Use the 2nd Encoder for Frequency Dividing Output or Not			
			0	Use the first encoder frequency dividing output		
			1	Use the second encoder frequency dividing output		
			Pn210.2: PG Frequency Dividing Pulse Phase Selection			
			0	Maintain existing state		
			1	Invert the phase of the frequency-dividing pulse		
			Pn210.3: 2nd Encoder Pulse Counting Direction			
			0	[0] Unchanged		
		1	Invert			
Pn211	Application Function Setting 211	b0000 ~ b0001	0001	—	After restart	
Pn300	Analog Speed Reference Input Gain	0 to 3000	150	rpm/v	Immediately	
	The corresponding speed to 1V analog input.					
Pn301	Analog Speed Given Zero Bias	-1000 to 1000	10 mV	0	Immediately	
	<p>This parameter is used to set zero bias of analog speed given, and it is related with the analog speed reference input gain (Pn300). The analog speed reference after setting is calculated as follows:</p> <p>Analog speed reference=(Speed reference input analog voltage –Analog speed reference zero bias)×Analog speed reference input gain</p>					
Pn302	Analog Speed Command Gain 2	0 ~ 3000	150	rpm/v	Immediately	
	The speed value corresponding to analog input per volt.					

No.	Index	Name	Range	Unit	Default
Pn304	Inner Speed Reference	-6000 to 6000	rpm	500	Immediately
	To set the inner Motor speed reference. This setting is available when servo is in inner speed control mode (Pn006.0 = 0 and Pn005.1 = 1).				
Pn305	Jogging Speed	0 to 6000	rpm	500	Immediately
	To set a speed for the Motor in JOG operation, and the rotation direction is determined by the reference.				
Pn306	Soft Start Acceleration Time	0 to 10000	ms	0	Immediately
	The time to accelerate the motor to 1000rpm on slope speed reference.				
Pn307	Soft Start Deceleration Time	0 to 10000	ms	0	Immediately
	The time to decelerate to 1000rpm on slope speed reference.				
Pn308	Speed Reference Filter Time	0 to 10000	ms	0	Immediately
	To set speed reference filter time.				
Pn309	S-Curve Rise Time	0 to 10000	ms	0	Immediately
	To set a rise time for transiting from one speed point to another speed point in the S-curve.				
Pn310	Speed Reference Smooth Mode Selection	0 to 3	-	0	After restart
	[0] Ramp [1] S-Curve [2] Primary filtering [3] Secondary filtering				
Pn311	S-Curve Selection	0 to 3	-	0	After restart
	To set the transition form of the S-curve.				

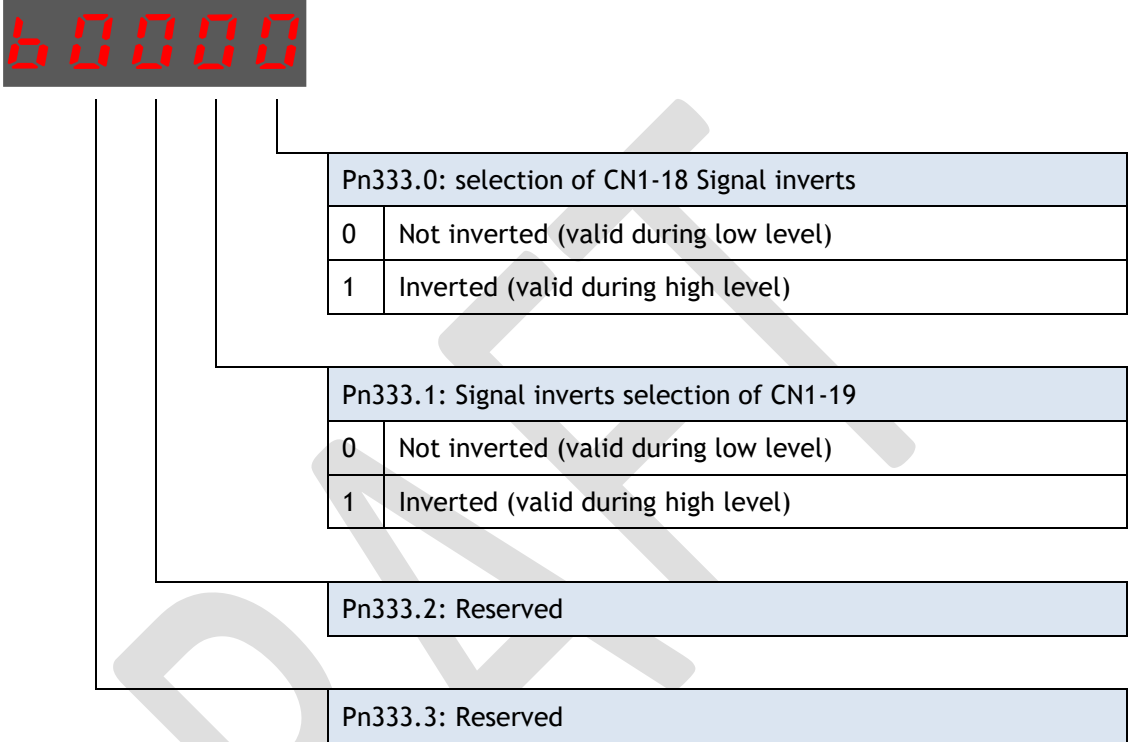

No.	Index	Name	Range	Unit	Default
Pn316	Internal Speed 1	-6000 to 6000	rpm	100	Immediately
	The settings of Pn316 to Pn322 are valid when Pn005.1=3, 4, 5 or 6. The table below lists the conditions for each internal speed switching.				
	Input Signal			Speed Selection	
	/P-CON	/PCL	/NCL		
	OFF(H)	OFF(H)	OFF(H)	Zero speed or switch to other control methods	
		OFF(H)	ON(L)	Internal Speed 1	
		ON(L)	OFF(H)	Internal Speed 2	
	ON(L)	ON(L)	ON(L)	Internal Speed 3	
		OFF(H)	OFF(H)	Internal Speed 4	
		OFF(H)	ON(L)	Internal Speed 5	
ON(L)		OFF(H)	Internal Speed 6		
	ON(L)	ON(L)	Internal Speed 7		
Pn317	Internal Speed 2	-6000 to 6000	rpm	200	Immediately
	Refer to the descriptions in Pn316.				
Pn318	Internal Speed 3	-6000 to 6000	rpm	300	Immediately
	Refer to the descriptions in Pn316.				
Pn319	Internal Speed 4	-6000 to 6000	rpm	-100	Immediately
	Refer to the descriptions in Pn316.				
Pn320	Internal Speed 5	-6000 to 6000	rpm	-200	Immediately
	Refer to the descriptions in Pn316.				
Pn321	Internal Speed 6	-6000 to 6000	rpm	-300	Immediately
	Refer to the descriptions in Pn316.				
Pn322	Internal Speed 7	-6000 to 6000	rpm	500	Immediately
	Refer to the descriptions in Pn316.				
Pn323	Overspeed Detection Threshold	1 to 8000	rpm	8000	Immediately
	A.03 alarm occurs if the Motor velocity exceeds this threshold.				

No.	Index	Name	Range	Unit	Default								
Pn324	PCP Controls Time of Stopping Acceleration	0 to 10000	ms	100	Immediately								
	The time required for trapezoidal deceleration of 1000 rpm under the indexing function.												
Pn325	Max. Limit Value of Soft Limit	-	2000000000	P	Immediately								
	The maximum limit value of soft limit in absolute position												
Pn326	Min. Limit Value of Soft Limit	-	-2000000000	P	Immediately								
	The minimum limit value in absolute position												
Pn331	TouchProbe Input Port Allocation	0000 to 0022	-	0010	After restart								
													
	<table border="1"> <thead> <tr> <th colspan="2">Pn331.0: CN1-18 Allocation Signal</th> </tr> </thead> <tbody> <tr> <td>0</td> <td>Allocate TP1 signal to CN1-18</td> </tr> <tr> <td>1</td> <td>Allocate TP2 signal to CN1-18</td> </tr> <tr> <td>2</td> <td>Do not allocate Touch Probe signal</td> </tr> </tbody> </table>					Pn331.0: CN1-18 Allocation Signal		0	Allocate TP1 signal to CN1-18	1	Allocate TP2 signal to CN1-18	2	Do not allocate Touch Probe signal
	Pn331.0: CN1-18 Allocation Signal												
	0	Allocate TP1 signal to CN1-18											
	1	Allocate TP2 signal to CN1-18											
2	Do not allocate Touch Probe signal												
<table border="1"> <thead> <tr> <th colspan="2">Pn331.1: CN1-19 Allocation Signal</th> </tr> </thead> <tbody> <tr> <td>0</td> <td>Allocate TP1 signal to CN1-19</td> </tr> <tr> <td>1</td> <td>Allocate TP2 signal to CN1-19</td> </tr> <tr> <td>2</td> <td>Do not allocate Touch Probe signal</td> </tr> </tbody> </table>					Pn331.1: CN1-19 Allocation Signal		0	Allocate TP1 signal to CN1-19	1	Allocate TP2 signal to CN1-19	2	Do not allocate Touch Probe signal	
Pn331.1: CN1-19 Allocation Signal													
0	Allocate TP1 signal to CN1-19												
1	Allocate TP2 signal to CN1-19												
2	Do not allocate Touch Probe signal												
Pn331.2: Reserved													
Pn331.3: Reserved													

No.	Index	Name	Range	Unit	Default
Pn332	Touch Probe Digital Input Filtering Time	0 to 200	10ns	100	After restart
	–				
Pn333	TouchProbe Input Port Signal Inverts	0000 to 0011	–	0000	After restart
					
	Pn333.0: selection of CN1-18 Signal inverts				
	0	Not inverted (valid during low level)			
	1	Inverted (valid during high level)			
	Pn333.1: Signal inverts selection of CN1-19				
0	Not inverted (valid during low level)				
1	Inverted (valid during high level)				
Pn333.2: Reserved					
Pn333.3: Reserved					
Pn400	Analog Torque Reference Gain	10 to 100	0.1V/100%	33	Immediately
	This parameter sets the voltage value of the analog input required to reach the rated torque.				
Pn401	Forward Torque Internal Limit	0 to 350	%	350	Immediately
	The value of motor output torque limit, and the parameter setting range is based on the actual overload capacity.				
Pn402	Reverse Torque Internal Limit	0 to 350	%	300	Immediately
	The value of motor output torque limit, and the parameter setting range is based on the actual overload capacity.				
Pn403	Forward Torque External Limit	0 to 350	%	100	Immediately
	The value of motor output torque limit, and the parameter setting range is based on the actual overload capacity.				

No.	Index	Name	Range	Unit	Default
Pn404	Reverse Torque External Limit	0 to 350	%	100	Immediately
	The value of motor output torque limit, and the parameter setting range is based on the actual overload capacity.				
Pn405	Reverse Brake Torque Limit	0 to 350	%	300	Immediately
	The value of motor output torque limit, and the parameter setting range is based on the actual overload capacity.				
Pn406	Torque Limit at Main Circuit Voltage Drop	0 to 100	%	50	Immediately
	-				
Pn407	Release Time for Torque Limit at Main Circuit Voltage Drop	0 to 1000	ms	100	Immediately
	-				
Pn408	Speed Limit during Torque Control	0 to 6000	rpm	1500	Immediately
	-				
Pn409	Torque Mode	0 to 1	-	0	Immediately
	0: Analog torque mode 1: Torque contact mode				
Pn410	Torque Contact 1	-400 to 400	1/100%	0	Immediately
	-				
Pn411	Torque Contact 2	-400 to 400	1/100%	0	Immediately
	-				
Pn412	Torque Contact 3	-400 to 400	1/100%	0	Immediately
	-				
Pn413	Torque Contact 4	-400 to 400	1/100%	0	Immediately
	-				
Pn414	Analog Torque Command Gain 2	10 ~ 100	0.1V/100%	Pn414	Immediately
	The parameter means the voltage value of the analog input required to achieve the rated torque.				

No.	Index	Name	Range	Unit	Default
Pn415	Analog Torque Given Zero Bias	-1000 to 1000	10 mv	0	Immediately
	–				
Pn500	Position Arrival Tolerance	0 to 50000	pulse	10	Immediately
	The /COIN (Positioning Completion) output signal will turn ON when the deviation counter is less than this setting.				
Pn501	Speed Arrival Tolerance	0 to 100	rpm	10	Immediately
	The /VCMP (Speed Coincidence Detection) output signal will turn ON when the deviation between the speed reference and speed feedback is less than this setting.				
Pn502	Zero Clamp Speed	0 to 3000	rpm	10	Immediately
	Locks motor at the current position when the input analog speed drops below this value.				
Pn503	Rotation Status Detection Threshold	0 to 3000	rpm	20	Immediately
	It is considered the Motor has been rotated stably and the /TGON (Rotation Detection) output signal turns ON when the Motor speed exceeds this setting.				
Pn504	Position Deviation Counter Overflow Threshold	1 to 83886080	pulse	1	Immediately
	It is considered the deviation counter has been overflowed and an alarm signal outputs when the deviation counter exceeds this setting. NOTE: the default setting depends on the encoder resolution.				
Pn505	Servo ON Waiting Time	-2000 to 2000	ms	0	Immediately
	Parameters from Pn505 to Pn508 are available only when the /BK (Brake Output) signal turns ON. They are used for controlling the holding brake, so that the moving part of the machine cannot move due to gravity or an external force. <ul style="list-style-type: none"> • If this setting is a positive number, when the servo is ON, the /BK signal will turn ON firstly, and wait for this setting time, then excite the Motor. • If the setting is a negative number, when the servo is ON, the Motor can be excited immediately, and wait for this setting time, then the /BK signal will turn ON. 				
Pn506	Servo OFF Waiting Time	0 to 500	10 ms	0	Immediately
	The Servo is OFF when setting it as the /BK output (braking acts.) In this case, the machine may sometimes move slightly under the influence of gravity., depending on its components as well as the characteristics of the brake.				
Pn507	Brake Enable Speed Threshold	10 to 100	rpm	100	Immediately
	The /BK signal will turn ON when the Motor speed is lower than this setting after the Servo is OFF.				

No.	Index	Name	Range	Unit	Default																																																									
Pn508	Brake Enable Waiting Time	10 to 100	10 ms	50	Immediately																																																									
	The /BK signal will turn ON when the delay exceeds this setting after the Servo is OFF. The /BK signal turns ON as long as one of the conditions, Brake Reference Waiting Speed and Brake Reference Waiting Time, is satisfied.																																																													
Pn509	Digital Input Signal Allocations 1	h00000000 to h1C1C1C1C	-	03020100	After restart																																																									
	<div style="display: flex; justify-content: space-around; align-items: flex-start;"> <div style="text-align: center;">  <p>Pn509.0: 为 CN1-14 分配信号</p> <table border="1" style="width: 100%; border-collapse: collapse;"> <tr><td>00</td><td>S-ON</td></tr> <tr><td>01</td><td>P-CON</td></tr> <tr><td>02</td><td>P-OT</td></tr> <tr><td>03</td><td>N-OT</td></tr> <tr><td>04</td><td>ALMRST</td></tr> <tr><td>05</td><td>CLR</td></tr> <tr><td>06</td><td>P-CL</td></tr> <tr><td>07</td><td>N-CL</td></tr> <tr><td>08</td><td>G-SEL</td></tr> <tr><td>09</td><td>JDPOS-JOG+</td></tr> <tr><td>0A</td><td>JDPOS-JOG-</td></tr> <tr><td>0B</td><td>JDPOS-HALT</td></tr> <tr><td>0C</td><td>HmRef</td></tr> <tr><td>0D</td><td>SHOM</td></tr> <tr><td>0E</td><td>ORG</td></tr> <tr><td>0F</td><td>ZCLAMP</td></tr> <tr><td>10</td><td>TORQ_JD1</td></tr> <tr><td>11</td><td>TORQ_JD2</td></tr> <tr><td>12</td><td>TORQ_SPEED_LIMIT1</td></tr> <tr><td>13</td><td>TORQ_SPEED_LIMIT2</td></tr> <tr><td>14</td><td>ANLOD_REV</td></tr> <tr><td>15</td><td>POS0</td></tr> <tr><td>16</td><td>POS1</td></tr> <tr><td>17</td><td>POS2</td></tr> <tr><td>18</td><td>POS3</td></tr> <tr><td>19</td><td>POS4</td></tr> <tr><td>1A</td><td>ANAG_SEL</td></tr> <tr><td> </td><td> </td></tr> <tr><td> </td><td> </td></tr> </table> <p>Pn509.1: Corresponds to port CN1_15 or virtual input bit1 00-1A: Same allocation as CN1-14.</p> </div> <div style="text-align: center;">  <p>Pn509.2: Corresponds to port CN1_16 or virtual input bit2 00-1A: Same allocation as CN1-14.</p> <p>Pn509.3: Corresponds to port CN1_17 or virtual input bit3 00-1A: Same allocation as CN1-14.</p> </div> </div>					00	S-ON	01	P-CON	02	P-OT	03	N-OT	04	ALMRST	05	CLR	06	P-CL	07	N-CL	08	G-SEL	09	JDPOS-JOG+	0A	JDPOS-JOG-	0B	JDPOS-HALT	0C	HmRef	0D	SHOM	0E	ORG	0F	ZCLAMP	10	TORQ_JD1	11	TORQ_JD2	12	TORQ_SPEED_LIMIT1	13	TORQ_SPEED_LIMIT2	14	ANLOD_REV	15	POS0	16	POS1	17	POS2	18	POS3	19	POS4	1A	ANAG_SEL			
00	S-ON																																																													
01	P-CON																																																													
02	P-OT																																																													
03	N-OT																																																													
04	ALMRST																																																													
05	CLR																																																													
06	P-CL																																																													
07	N-CL																																																													
08	G-SEL																																																													
09	JDPOS-JOG+																																																													
0A	JDPOS-JOG-																																																													
0B	JDPOS-HALT																																																													
0C	HmRef																																																													
0D	SHOM																																																													
0E	ORG																																																													
0F	ZCLAMP																																																													
10	TORQ_JD1																																																													
11	TORQ_JD2																																																													
12	TORQ_SPEED_LIMIT1																																																													
13	TORQ_SPEED_LIMIT2																																																													
14	ANLOD_REV																																																													
15	POS0																																																													
16	POS1																																																													
17	POS2																																																													
18	POS3																																																													
19	POS4																																																													
1A	ANAG_SEL																																																													

No.	Index	Name	Range	Unit	Default																																																														
Pn510	输入信号分配 2	h00000000 to h1C1C1C1C	-	07060504	After restart																																																														
	<div style="display: flex; justify-content: space-around; align-items: center;"> <div style="border: 1px solid black; padding: 5px; background-color: #333; color: red; font-weight: bold; font-size: 1.2em;">_ 0504</div> <div style="border: 1px solid black; padding: 5px; background-color: #333; color: red; font-weight: bold; font-size: 1.2em;">- 0706</div> </div>																																																																		
			<table border="1" style="width: 100%; border-collapse: collapse;"> <tr> <th colspan="2">Pn510.0: 为 CN1-39 分配信号</th> </tr> <tr><td>00</td><td>S-ON</td></tr> <tr><td>01</td><td>P-CON</td></tr> <tr><td>02</td><td>P-OT</td></tr> <tr><td>03</td><td>N-OT</td></tr> <tr><td>04</td><td>ALMRST</td></tr> <tr><td>05</td><td>CLR</td></tr> <tr><td>06</td><td>P-CL</td></tr> <tr><td>07</td><td>N-CL</td></tr> <tr><td>08</td><td>G-SEL</td></tr> <tr><td>09</td><td>JDPOS-JOG+</td></tr> <tr><td>0A</td><td>JDPOS-JOG-</td></tr> <tr><td>0B</td><td>JDPOS-HALT</td></tr> <tr><td>0C</td><td>HmRef</td></tr> <tr><td>0D</td><td>SHOM</td></tr> <tr><td>0E</td><td>ORG</td></tr> <tr><td>0F</td><td>ZCLAMP</td></tr> <tr><td>10</td><td>TORQ_JD1</td></tr> <tr><td>11</td><td>TORQ_JD2</td></tr> <tr><td>12</td><td>TORQ_SPEED_LIMIT1</td></tr> <tr><td>13</td><td>TORQ_SPEED_LIMIT2</td></tr> <tr><td>14</td><td>ANL0D_REV</td></tr> <tr><td>15</td><td>POS0</td></tr> <tr><td>16</td><td>POS1</td></tr> <tr><td>17</td><td>POS2</td></tr> <tr><td>18</td><td>POS3</td></tr> <tr><td>19</td><td>POS4</td></tr> <tr><td>1A</td><td>MDP1</td></tr> <tr><td> </td><td> </td></tr> <tr><td> </td><td> </td></tr> </table>		Pn510.0: 为 CN1-39 分配信号		00	S-ON	01	P-CON	02	P-OT	03	N-OT	04	ALMRST	05	CLR	06	P-CL	07	N-CL	08	G-SEL	09	JDPOS-JOG+	0A	JDPOS-JOG-	0B	JDPOS-HALT	0C	HmRef	0D	SHOM	0E	ORG	0F	ZCLAMP	10	TORQ_JD1	11	TORQ_JD2	12	TORQ_SPEED_LIMIT1	13	TORQ_SPEED_LIMIT2	14	ANL0D_REV	15	POS0	16	POS1	17	POS2	18	POS3	19	POS4	1A	MDP1							
	Pn510.0: 为 CN1-39 分配信号																																																																		
	00	S-ON																																																																	
	01	P-CON																																																																	
	02	P-OT																																																																	
	03	N-OT																																																																	
	04	ALMRST																																																																	
	05	CLR																																																																	
	06	P-CL																																																																	
	07	N-CL																																																																	
	08	G-SEL																																																																	
	09	JDPOS-JOG+																																																																	
	0A	JDPOS-JOG-																																																																	
0B	JDPOS-HALT																																																																		
0C	HmRef																																																																		
0D	SHOM																																																																		
0E	ORG																																																																		
0F	ZCLAMP																																																																		
10	TORQ_JD1																																																																		
11	TORQ_JD2																																																																		
12	TORQ_SPEED_LIMIT1																																																																		
13	TORQ_SPEED_LIMIT2																																																																		
14	ANL0D_REV																																																																		
15	POS0																																																																		
16	POS1																																																																		
17	POS2																																																																		
18	POS3																																																																		
19	POS4																																																																		
1A	MDP1																																																																		
				<table border="1" style="width: 100%; border-collapse: collapse;"> <tr> <td colspan="2">Pn510.2: Corresponds to port CN1_41 or virtual input bit6</td> </tr> <tr> <td colspan="2">00-1A: Same allocation as CN1-39.</td> </tr> </table>		Pn510.2: Corresponds to port CN1_41 or virtual input bit6		00-1A: Same allocation as CN1-39.																																																											
Pn510.2: Corresponds to port CN1_41 or virtual input bit6																																																																			
00-1A: Same allocation as CN1-39.																																																																			
				<table border="1" style="width: 100%; border-collapse: collapse;"> <tr> <td colspan="2">Pn510.3: Corresponds to port CN1_42 or virtual input bit7</td> </tr> <tr> <td colspan="2">00-1A: Same allocation as CN1-39.</td> </tr> </table>		Pn510.3: Corresponds to port CN1_42 or virtual input bit7		00-1A: Same allocation as CN1-39.																																																											
Pn510.3: Corresponds to port CN1_42 or virtual input bit7																																																																			
00-1A: Same allocation as CN1-39.																																																																			
				<table border="1" style="width: 100%; border-collapse: collapse;"> <tr> <td colspan="2">Pn510.1: Corresponds to port CN1_40 or virtual input bit5</td> </tr> <tr> <td colspan="2">00 - 1A: Same allocation as CN1-39.</td> </tr> </table>		Pn510.1: Corresponds to port CN1_40 or virtual input bit5		00 - 1A: Same allocation as CN1-39.																																																											
Pn510.1: Corresponds to port CN1_40 or virtual input bit5																																																																			
00 - 1A: Same allocation as CN1-39.																																																																			

No.	Index	Name	Range	Unit	Default
	Digital Output Signal Allocations	h0000 to h0ccc	-	0210	After restart
Pn511					
	Pn511.0: Allocate signal to CN1-11, 12				
	0	COIN/VCMP			
	1	TGON			
	2	S-RDY			
	3	CLT			
	4	BK			
	5	PGC			
	6	OT			
	7	RD			
	8	HOME			
	9	TCR			
	A	R-OUT1			
	B	R-OUT2			
	C	R-OUT3			
Pn511.1: Allocate signal to CN1-05, 06					
0 to B: same as the allocation of CN1-11, 12					
Pn511.2: Allocate signal to CN1-09, 10					
0 to B: same as the allocation of CN1-11, 12					
Pn511.3: Reserved setting (Do not change).					

No.	Index	Name	Range	Unit	Default
Pn512	Digital Input Signals (Low Bits) from Bus Master	b0000 to b1111	–	0000	After restart
					
	Pn512.0: Select and allocate CN-14 through the bus master				
	0 Not enabled.				
	1 Enabled.				
	Pn512.1: Select and allocate CN-15 through the bus master				
	0 Not enabled.				
	1 Enabled.				
	Pn512.2: Select and allocate CN-16 through the bus master				
	0 Not enabled.				
	1 Enabled.				
	Pn512.3: Select and allocate CN-17 through the bus master				
	0 Not enabled.				
	1 Enabled.				

No.	Index	Name	Range	Unit	Default
Pn513	Digital Input Signals (High Bits) from Bus Master	b0000 to b1111	–	0000	After restart
					
	Pn513.0: Select and allocate CN-39 through the bus master				
	0 Not enabled.				
	1 Enabled.				
	Pn513.1: Select and allocate CN-40 through the bus master				
	0 Not enabled.				
	1 Enabled.				
	Pn513.2: Select and allocate CN-41 through the bus master				
	0 Not enabled.				
1 Enabled.					
Pn513.3: Select and allocate CN-42 through the bus master					
0 Not enabled.					
1 Enabled.					
Pn514	Input Port Filtering	0 to 1000	1 cycle	1	Immediately
	To set a filtering time for the input signals. If you increase this setting, the signal changes on the input port will be delayed.				
Pn515	Alarm Output Signal Filter Time	0 to 3	2 cycles	1	Immediately
	To set a filtering time for the alarm signals. If you increase this setting, the alarm will be delayed.				

No.	Index	Name	Range	Unit	Default
Pn516	Digital Input Signal Inverts 1	b0000 to b1111	–	0000	After restart
					
	Pn516.0: CN1-14 inverse selection				
	0	The signal is not inverted.			
	1	The signal is inverted.			
	Pn516.1: CN1-15 inverse selection				
	0	The signal is not inverted.			
	1	The signal is inverted.			
	Pn516.2: CN1-16 inverse selection				
	0	The signal is not inverted.			
	1	The signal is inverted.			
	Pn516.3: CN1-17 inverse selection				
	0	The signal is not inverted.			
	1	The signal is inverted.			

No.	Index	Name	Range	Unit	Default						
Pn517	Digital Input Signal Inverts 2	0000 to 1111	–	0000	After restart						
											
	<table border="1"> <thead> <tr> <th colspan="2">Pn517.0: CN1-39 inverse selection</th> </tr> </thead> <tbody> <tr> <td>0</td> <td>The signal is not inverted.</td> </tr> <tr> <td>1</td> <td>The signal is inverted.</td> </tr> </tbody> </table>					Pn517.0: CN1-39 inverse selection		0	The signal is not inverted.	1	The signal is inverted.
	Pn517.0: CN1-39 inverse selection										
	0	The signal is not inverted.									
	1	The signal is inverted.									
	<table border="1"> <thead> <tr> <th colspan="2">Pn517.1: CN1-40 inverse selection</th> </tr> </thead> <tbody> <tr> <td>0</td> <td>The signal is not inverted.</td> </tr> <tr> <td>1</td> <td>The signal is inverted.</td> </tr> </tbody> </table>					Pn517.1: CN1-40 inverse selection		0	The signal is not inverted.	1	The signal is inverted.
	Pn517.1: CN1-40 inverse selection										
	0	The signal is not inverted.									
	1	The signal is inverted.									
<table border="1"> <thead> <tr> <th colspan="2">Pn517.2: CN1-41 inverse selection</th> </tr> </thead> <tbody> <tr> <td>0</td> <td>The signal is not inverted.</td> </tr> <tr> <td>1</td> <td>The signal is inverted.</td> </tr> </tbody> </table>					Pn517.2: CN1-41 inverse selection		0	The signal is not inverted.	1	The signal is inverted.	
Pn517.2: CN1-41 inverse selection											
0	The signal is not inverted.										
1	The signal is inverted.										
<table border="1"> <thead> <tr> <th colspan="2">Pn517.3: CN1-42 inverse selection</th> </tr> </thead> <tbody> <tr> <td>0</td> <td>The signal is not inverted.</td> </tr> <tr> <td>1</td> <td>The signal is inverted.</td> </tr> </tbody> </table>					Pn517.3: CN1-42 inverse selection		0	The signal is not inverted.	1	The signal is inverted.	
Pn517.3: CN1-42 inverse selection											
0	The signal is not inverted.										
1	The signal is inverted.										
Pn518	Dynamic Braking Time	50 ~ 20000	20000	0.5ms	Immediately						
	The time required for dynamic braking of the motor.										
Pn519	Serial Encoder Communication Error Tolerance	0 to 10000	1 cycle	3	Immediately						
	The warning of serial encoder related alarms can be ignored if the alarms occurred within this setting.										
Pn520	Position Arrival Status Detection Time Threshold	0 to 60000	0.1 ms	500	Immediately						
	To set a required time for completing the positioning.										

No.	Index	Name	Range	Unit	Default
Pn521	Application Function Setting 521	b0000 to b0011	–	0010	After restart
					
	Pn521.0: A15 alarm mask bit (for drives of 400W and below, A.15 and A.16 use the same alarm mask bit Pn521.0; for drives of 800W and above, A.15 uses Pn521.0, and A.16 cannot be masked)				
	0	Do not mask.			
	1	Mask (when A15 is masked, the bleeder resistor will not work even if a bleeder battery is connected)			
Pn525	Pn521.1: A06 Mask				
	0	Do not mask.			
	1	Ignore the alarm.			
	Pn521.2: Reserved setting (Do not change).				
	Pn521.3: Reserved setting (Do not change).				
Pn525	Motor Overload Detection Start Threshold	100 to 150	%	100	Immediately
	A04 alarms occurs if the load percentage exceeds this setting more than a certain time. The recommended setting is 120 or less, otherwise the Drive or the Motor may be damaged. This setting is always 115 for the EM3A Motors.				

No.	Index	Name	Range	Unit	Default	
Pn528	Digital Output Signal Inverts	b0000 to b1111	–	0000	After restart	
						
	Pn528.0: CN1-05, -06 inverse selection					
	0	The signal is not inverted.				
	1	The signal is inverted.				
	Pn528.1: CN1-07, 08 inverse selection					
	0	The signal is not inverted.				
	1	The signal is inverted.				
	Pn528.2: CN1-09, 10 inverse selection					
	0	The signal is not inverted.				
	1	The signal is inverted.				
	Pn528.3: CN1-11, 12 inverse selection					
	0	The signal is not inverted.				
	1	The signal is inverted.				
	Pn529	Torque Reaches Status Detection Torque Threshold	3 to 300	%	100	Immediately
	The /TCR signal will be output when the torque output exceeds the setting in Pn529 and the time is longer than that set in Pn530.					
Pn530	Torque Detection Output Signal Time	1 to 1000	ms	10	Immediately	
The /TCR signal will be output when the torque output exceeds the setting in Pn529 and the time is longer than that set in Pn530.						
Pn531	Pulse Input Filter Time	10 to 100	10 ns	20	Immediately	
–						
Pn533	Current Threshold when DB Brake Circuit is Damaged	1 ~ 9999	300	mA	Immediately	
–						

No.	Index	Name	Range	Unit	Default
Pn534	Alarm Threshold in case of Excessive IPM Junction Temperature	1 ~ 200	135	°C	Immediately
	–				
Pn535	Discharging Resistor Resistance	25 to 300	Ω	50	After restart
	To set the resistance value for the braking.				
Pn536	Discharging Resistor Power	10 to 2000	W	60	After restart
	To set the resistance value for the braking.				
Pn538	Momentary Power Interruption Hold Time	0 to 50	period	1	Immediately
	<p>Even if the main power supply to the Drive is interrupted momentarily, power supply to the Motor (servo ON status) will be maintained for the time set by this parameter.</p> <p>The setting is a number of periods, and the time of one period depends on the setting of Pn007.3:</p> <ul style="list-style-type: none"> • Pn007.3=0, the time of one period is 1/50s. • Pn007.3=1, the time of one period is 1/60s. 				
Pn539	Pump-up Opening Delay Time	0 ~ 100	0	ms	Immediately
	–				
Pn540	Pump-up Closing Delay Time	0 ~ 100	0	ms	Immediately
	–				
Pn541	Current Threshold for Detecting Abnormal Operation	0 to 400	% In	200	Immediately
	Set a percentage threshold for the current to detect that the Motor has been operating abnormally.				
Pn542	Acceleration Threshold for Detecting Abnormal Operation	0 to 1000	krpm/s	50	Immediately
	Set a threshold for the acceleration to detect that the Motor has been operating abnormally.				
Pn685	Speed of Finding Reference Point	0 to 3000	rpm	1500	Immediately
	–				
Pn686	Speed of Homing	0 to 200	rpm	30	Immediately
	Sets the speed of the motor after reaching the limit switch.				

No.	Index	Name	Range	Unit	Default						
Pn689	Homing Mode Setting	b0000 to b1111	–	0000	After restart						
											
	<table border="1" style="width: 100%; border-collapse: collapse;"> <thead> <tr> <th colspan="2" style="background-color: #e1eef6;">Pn689.0: Homing Enabled</th> </tr> </thead> <tbody> <tr> <td style="text-align: center;">0</td> <td>Turn OFF the origin return function</td> </tr> <tr> <td style="text-align: center;">1</td> <td>Turn ON the origin return function</td> </tr> </tbody> </table>					Pn689.0: Homing Enabled		0	Turn OFF the origin return function	1	Turn ON the origin return function
	Pn689.0: Homing Enabled										
	0	Turn OFF the origin return function									
	1	Turn ON the origin return function									
	<table border="1" style="width: 100%; border-collapse: collapse;"> <thead> <tr> <th colspan="2" style="background-color: #e1eef6;">Pn689.1: Direct Homing After Power-on</th> </tr> </thead> <tbody> <tr> <td style="text-align: center;">0</td> <td>Homing triggered by SHOM signal</td> </tr> <tr> <td style="text-align: center;">1</td> <td>Direct homing after power-on</td> </tr> </tbody> </table>					Pn689.1: Direct Homing After Power-on		0	Homing triggered by SHOM signal	1	Direct homing after power-on
	Pn689.1: Direct Homing After Power-on										
	0	Homing triggered by SHOM signal									
	1	Direct homing after power-on									
<table border="1" style="width: 100%; border-collapse: collapse;"> <thead> <tr> <th colspan="2" style="background-color: #e1eef6;">Pn689.2: ORG Storage</th> </tr> </thead> <tbody> <tr> <td style="text-align: center;">0</td> <td>Do not store the origin</td> </tr> <tr> <td style="text-align: center;">1</td> <td>Store the origin</td> </tr> </tbody> </table>					Pn689.2: ORG Storage		0	Do not store the origin	1	Store the origin	
Pn689.2: ORG Storage											
0	Do not store the origin										
1	Store the origin										
<table border="1" style="width: 100%; border-collapse: collapse;"> <thead> <tr> <th colspan="2" style="background-color: #e1eef6;">Pn689.3: Actions when Encountering OT during Homing</th> </tr> </thead> <tbody> <tr> <td style="text-align: center;">0</td> <td>Return to find homing position after encountering OT</td> </tr> <tr> <td style="text-align: center;">1</td> <td>Enter limit status after encountering OT</td> </tr> </tbody> </table>					Pn689.3: Actions when Encountering OT during Homing		0	Return to find homing position after encountering OT	1	Enter limit status after encountering OT	
Pn689.3: Actions when Encountering OT during Homing											
0	Return to find homing position after encountering OT										
1	Enter limit status after encountering OT										
Pn690	Offset Pulse Number During Homing (High-Bit)	-9999 to 9999	10000 pulse	0	Immediately						
	The parameters Pn690 and Pn691 are used in combination, and their algebraic sum is the pulse number of the encoder offset required in the ZRN.										
Pn691	Offset Pulse Number During Homing (Low-Bit)	-9999 to 9999	1 pulse	0	Immediately						
	Please refer to the instructions in Pn691.										
Pn692	Selection of Homing Mode	0 to 10	–	0	Immediately						
	–										
Pn693	Homing Acceleration	0 to 5000	–	100	Immediately						

No.	Index	Name	Range	Unit	Default																				
Pn694	Origin Storage, Single-turn Position	-2147483648 to 2147483647	-	0	Immediately																				
Pn695	Origin Storage, Multi-turn Position	-2147483648 to 2147483647	-	0	Immediately																				
Pn700	Modbus Communication Setting	h0000 to h1182	-	0151	After restart																				
																									
	<table border="1"> <thead> <tr> <th colspan="2">Pn700.0: MODBUS Communication Baud Rate</th> </tr> </thead> <tbody> <tr> <td>0</td> <td>4800 bps</td> </tr> <tr> <td>1</td> <td>9600 bps</td> </tr> <tr> <td>2</td> <td>19200 bps</td> </tr> </tbody> </table>					Pn700.0: MODBUS Communication Baud Rate		0	4800 bps	1	9600 bps	2	19200 bps												
	Pn700.0: MODBUS Communication Baud Rate																								
	0	4800 bps																							
	1	9600 bps																							
	2	19200 bps																							
	<table border="1"> <thead> <tr> <th colspan="2">Pn700.1: Selection of MODBUS Protocol</th> </tr> </thead> <tbody> <tr> <td>0</td> <td>7, N, 2 (Modbus, ASCII)</td> </tr> <tr> <td>1</td> <td>7, E, 1 (Modbus, ASCII)</td> </tr> <tr> <td>2</td> <td>7, O, 1 (Modbus, ASCII)</td> </tr> <tr> <td>3</td> <td>8, N, 2 (Modbus, ASCII)</td> </tr> <tr> <td>4</td> <td>8, E, 1 (Modbus, ASCII)</td> </tr> <tr> <td>5</td> <td>8, O, 1 (Modbus, ASCII)</td> </tr> <tr> <td>6</td> <td>8, N, 2 (Modbus, RTU)</td> </tr> <tr> <td>7</td> <td>8, E, 1 (Modbus, RTU)</td> </tr> <tr> <td>8</td> <td>8, O, 1 (Modbus, RTU)</td> </tr> </tbody> </table>					Pn700.1: Selection of MODBUS Protocol		0	7, N, 2 (Modbus, ASCII)	1	7, E, 1 (Modbus, ASCII)	2	7, O, 1 (Modbus, ASCII)	3	8, N, 2 (Modbus, ASCII)	4	8, E, 1 (Modbus, ASCII)	5	8, O, 1 (Modbus, ASCII)	6	8, N, 2 (Modbus, RTU)	7	8, E, 1 (Modbus, RTU)	8	8, O, 1 (Modbus, RTU)
	Pn700.1: Selection of MODBUS Protocol																								
	0	7, N, 2 (Modbus, ASCII)																							
1	7, E, 1 (Modbus, ASCII)																								
2	7, O, 1 (Modbus, ASCII)																								
3	8, N, 2 (Modbus, ASCII)																								
4	8, E, 1 (Modbus, ASCII)																								
5	8, O, 1 (Modbus, ASCII)																								
6	8, N, 2 (Modbus, RTU)																								
7	8, E, 1 (Modbus, RTU)																								
8	8, O, 1 (Modbus, RTU)																								
<table border="1"> <thead> <tr> <th colspan="2">Pn700.2: SCI Communication Selection</th> </tr> </thead> <tbody> <tr> <td>0</td> <td>No protocol for SCI communication.</td> </tr> <tr> <td>1</td> <td>Use MODBUS in SCI communication.</td> </tr> </tbody> </table>					Pn700.2: SCI Communication Selection		0	No protocol for SCI communication.	1	Use MODBUS in SCI communication.															
Pn700.2: SCI Communication Selection																									
0	No protocol for SCI communication.																								
1	Use MODBUS in SCI communication.																								
<table border="1"> <thead> <tr> <th colspan="2">Pn700.3 Reserved</th> </tr> </thead> <tbody> <tr> <td colspan="2"></td> </tr> </tbody> </table>					Pn700.3 Reserved																				
Pn700.3 Reserved																									

No.	Index	Name	Range	Unit	Default
Pn701	MODBUS Axis Address	1 to 247	–	1	After restart
	The axis address during MODBUS protocol communication.				
Pn703	CAN Communication Settings	0 to 5	–	1	After restart
	[0] 50Kbps [1] 100Kbps [2] 125Kbps [3] 250Kbps [4] 500Kbps [5] 1Mbps				
Pn704	CAN Communication Node	1 to 127	–	1	After restart
	The axis address during CANopen communication.				
Pn705	DC Min. Cycle Threshold	1-9999999	11999	10ns	After restart
	To set the DC jitter threshold in the FPGA				
Pn706	Jitter of DC Max. Cycle Threshold	1-99999	499	10ns	Immediately
	To set the DC jitter threshold in the FPGA				

No.	Index	Name	Range	Unit	Default																																																												
Pn709	Allocate virtual input signal to port 1	h00000000 to h1C1C1C1C	-	0B0A0908	Immediately																																																												
	<div style="display: flex; justify-content: space-around;"> <div style="border: 1px solid black; padding: 2px; background-color: #333; color: red; font-weight: bold; font-size: 1.2em;">_ 0908</div> <div style="border: 1px solid black; padding: 2px; background-color: #333; color: red; font-weight: bold; font-size: 1.2em;">- 060A</div> </div>																																																																
	<table border="1" style="width: 100%; border-collapse: collapse;"> <thead> <tr> <th colspan="2">Pn709.0: Allocate signal to Bit8</th> </tr> </thead> <tbody> <tr><td>00</td><td>S-ON</td></tr> <tr><td>01</td><td>P-CON</td></tr> <tr><td>02</td><td>P-OT</td></tr> <tr><td>03</td><td>N-OT</td></tr> <tr><td>04</td><td>ALMRST</td></tr> <tr><td>05</td><td>CLR</td></tr> <tr><td>06</td><td>P-CL</td></tr> <tr><td>07</td><td>N-CL</td></tr> <tr><td>08</td><td>G-SEL</td></tr> <tr><td>09</td><td>JDPOS-JOG+</td></tr> <tr><td>0A</td><td>JDPOS-JOG-</td></tr> <tr><td>0B</td><td>JDPOS-HALT</td></tr> <tr><td>0C</td><td>HmRef</td></tr> <tr><td>0D</td><td>SHOM</td></tr> <tr><td>0E</td><td>ORG</td></tr> <tr><td>0F</td><td>ZCLAMP</td></tr> <tr><td>10</td><td>TORQ_JD1</td></tr> <tr><td>11</td><td>TORQ_JD2</td></tr> <tr><td>12</td><td>TORQ_SPEED_LIMIT1</td></tr> <tr><td>13</td><td>TORQ_SPEED_LIMIT2</td></tr> <tr><td>14</td><td>ANLOD_REV</td></tr> <tr><td>15</td><td>POS0</td></tr> <tr><td>16</td><td>POS1</td></tr> <tr><td>17</td><td>POS2</td></tr> <tr><td>18</td><td>POS3</td></tr> <tr><td>19</td><td>POS4</td></tr> <tr><td>1A</td><td>MDP1</td></tr> <tr><td>1B</td><td>MD0</td></tr> <tr><td>1C</td><td>MD1</td></tr> </tbody> </table>		Pn709.0: Allocate signal to Bit8		00	S-ON	01	P-CON	02	P-OT	03	N-OT	04	ALMRST	05	CLR	06	P-CL	07	N-CL	08	G-SEL	09	JDPOS-JOG+	0A	JDPOS-JOG-	0B	JDPOS-HALT	0C	HmRef	0D	SHOM	0E	ORG	0F	ZCLAMP	10	TORQ_JD1	11	TORQ_JD2	12	TORQ_SPEED_LIMIT1	13	TORQ_SPEED_LIMIT2	14	ANLOD_REV	15	POS0	16	POS1	17	POS2	18	POS3	19	POS4	1A	MDP1	1B	MD0	1C	MD1			
	Pn709.0: Allocate signal to Bit8																																																																
	00	S-ON																																																															
	01	P-CON																																																															
	02	P-OT																																																															
	03	N-OT																																																															
	04	ALMRST																																																															
	05	CLR																																																															
06	P-CL																																																																
07	N-CL																																																																
08	G-SEL																																																																
09	JDPOS-JOG+																																																																
0A	JDPOS-JOG-																																																																
0B	JDPOS-HALT																																																																
0C	HmRef																																																																
0D	SHOM																																																																
0E	ORG																																																																
0F	ZCLAMP																																																																
10	TORQ_JD1																																																																
11	TORQ_JD2																																																																
12	TORQ_SPEED_LIMIT1																																																																
13	TORQ_SPEED_LIMIT2																																																																
14	ANLOD_REV																																																																
15	POS0																																																																
16	POS1																																																																
17	POS2																																																																
18	POS3																																																																
19	POS4																																																																
1A	MDP1																																																																
1B	MD0																																																																
1C	MD1																																																																
		<table border="1" style="width: 100%; border-collapse: collapse;"> <thead> <tr> <th colspan="2">Pn709.2: Allocate signal to Bit10</th> </tr> </thead> <tbody> <tr> <td>00to1C:</td> <td>same as the allocation of Bit8</td> </tr> </tbody> </table>		Pn709.2: Allocate signal to Bit10		00to1C:	same as the allocation of Bit8																																																										
Pn709.2: Allocate signal to Bit10																																																																	
00to1C:	same as the allocation of Bit8																																																																
		<table border="1" style="width: 100%; border-collapse: collapse;"> <thead> <tr> <th colspan="2">Pn709.3: Allocate signal to Bit11</th> </tr> </thead> <tbody> <tr> <td>00to1C:</td> <td>same as the allocation of Bit8</td> </tr> </tbody> </table>		Pn709.3: Allocate signal to Bit11		00to1C:	same as the allocation of Bit8																																																										
Pn709.3: Allocate signal to Bit11																																																																	
00to1C:	same as the allocation of Bit8																																																																
		<table border="1" style="width: 100%; border-collapse: collapse;"> <thead> <tr> <th colspan="2">Pn709.1: Allocate signal to Bit9</th> </tr> </thead> <tbody> <tr> <td>00 to 1C:</td> <td>same as the allocation of Bit8</td> </tr> </tbody> </table>		Pn709.1: Allocate signal to Bit9		00 to 1C:	same as the allocation of Bit8																																																										
Pn709.1: Allocate signal to Bit9																																																																	
00 to 1C:	same as the allocation of Bit8																																																																



No.	Index	Name	Range	Unit	Default																																																													
Pn710	Allocate virtual input signal to port 2	h00000000 to h1C1C1C1C	-	0F0E0D0C	Immediately																																																													
	<div style="display: flex; justify-content: space-around;"> <div style="border: 1px solid black; padding: 5px; background-color: #333; color: red; text-align: center; width: 100px;">_ 0 d 0 C</div> <div style="border: 1px solid black; padding: 5px; background-color: #333; color: red; text-align: center; width: 100px;">- 0 F 0 E</div> </div>																																																																	
			<table border="1" style="width: 100%; border-collapse: collapse;"> <thead> <tr> <th colspan="2">Pn710.0: Allocate signal to Bit12</th> </tr> </thead> <tbody> <tr><td>00</td><td>S-ON</td></tr> <tr><td>01</td><td>P-CON</td></tr> <tr><td>02</td><td>P-OT</td></tr> <tr><td>03</td><td>N-OT</td></tr> <tr><td>04</td><td>ALMRST</td></tr> <tr><td>05</td><td>CLR</td></tr> <tr><td>06</td><td>P-CL</td></tr> <tr><td>07</td><td>N-CL</td></tr> <tr><td>08</td><td>G-SEL</td></tr> <tr><td>09</td><td>JDPOS-JOG+</td></tr> <tr><td>0A</td><td>JDPOS-JOG-</td></tr> <tr><td>0B</td><td>JDPOS-HALT</td></tr> <tr><td>0C</td><td>HmRef</td></tr> <tr><td>0D</td><td>SHOM</td></tr> <tr><td>0E</td><td>ORG</td></tr> <tr><td>0F</td><td>ZCLAMP</td></tr> <tr><td>10</td><td>TORQ_JD1</td></tr> <tr><td>11</td><td>TORQ_JD2</td></tr> <tr><td>12</td><td>TORQ_SPEED_LIMIT1</td></tr> <tr><td>13</td><td>TORQ_SPEED_LIMIT2</td></tr> <tr><td>14</td><td>ANLOD_REV</td></tr> <tr><td>15</td><td>POS0</td></tr> <tr><td>16</td><td>POS1</td></tr> <tr><td>17</td><td>POS2</td></tr> <tr><td>18</td><td>POS3</td></tr> <tr><td>19</td><td>POS4</td></tr> <tr><td>1A</td><td>MDP1</td></tr> <tr><td>1B</td><td>MD0</td></tr> <tr><td>1C</td><td>MD1</td></tr> </tbody> </table>	Pn710.0: Allocate signal to Bit12		00	S-ON	01	P-CON	02	P-OT	03	N-OT	04	ALMRST	05	CLR	06	P-CL	07	N-CL	08	G-SEL	09	JDPOS-JOG+	0A	JDPOS-JOG-	0B	JDPOS-HALT	0C	HmRef	0D	SHOM	0E	ORG	0F	ZCLAMP	10	TORQ_JD1	11	TORQ_JD2	12	TORQ_SPEED_LIMIT1	13	TORQ_SPEED_LIMIT2	14	ANLOD_REV	15	POS0	16	POS1	17	POS2	18	POS3	19	POS4	1A	MDP1	1B	MD0	1C	MD1			
	Pn710.0: Allocate signal to Bit12																																																																	
	00	S-ON																																																																
	01	P-CON																																																																
	02	P-OT																																																																
	03	N-OT																																																																
	04	ALMRST																																																																
	05	CLR																																																																
	06	P-CL																																																																
	07	N-CL																																																																
	08	G-SEL																																																																
	09	JDPOS-JOG+																																																																
	0A	JDPOS-JOG-																																																																
0B	JDPOS-HALT																																																																	
0C	HmRef																																																																	
0D	SHOM																																																																	
0E	ORG																																																																	
0F	ZCLAMP																																																																	
10	TORQ_JD1																																																																	
11	TORQ_JD2																																																																	
12	TORQ_SPEED_LIMIT1																																																																	
13	TORQ_SPEED_LIMIT2																																																																	
14	ANLOD_REV																																																																	
15	POS0																																																																	
16	POS1																																																																	
17	POS2																																																																	
18	POS3																																																																	
19	POS4																																																																	
1A	MDP1																																																																	
1B	MD0																																																																	
1C	MD1																																																																	
		<table border="1" style="width: 100%; border-collapse: collapse;"> <thead> <tr> <th colspan="2">Pn710.2: Allocate signal to Bit14</th> </tr> </thead> <tbody> <tr> <td>00to1C:</td> <td>same as the allocation of Bit12</td> </tr> </tbody> </table>	Pn710.2: Allocate signal to Bit14		00to1C:	same as the allocation of Bit12																																																												
Pn710.2: Allocate signal to Bit14																																																																		
00to1C:	same as the allocation of Bit12																																																																	
		<table border="1" style="width: 100%; border-collapse: collapse;"> <thead> <tr> <th colspan="2">Pn710.3: Allocate signal to Bit15</th> </tr> </thead> <tbody> <tr> <td>00to1C:</td> <td>same as the allocation of Bit12</td> </tr> </tbody> </table>	Pn710.3: Allocate signal to Bit15		00to1C:	same as the allocation of Bit12																																																												
Pn710.3: Allocate signal to Bit15																																																																		
00to1C:	same as the allocation of Bit12																																																																	
		<table border="1" style="width: 100%; border-collapse: collapse;"> <thead> <tr> <th colspan="2">Pn710.1: Allocate signal to Bit1</th> </tr> </thead> <tbody> <tr> <td>00 to 1C:</td> <td>same as the allocation of Bit12</td> </tr> </tbody> </table>	Pn710.1: Allocate signal to Bit1		00 to 1C:	same as the allocation of Bit12																																																												
Pn710.1: Allocate signal to Bit1																																																																		
00 to 1C:	same as the allocation of Bit12																																																																	

No.	Index	Name	Range	Unit	Default	
Pn716	Virtual Input Port Signal Inverts1	b0000 to b1111	-	0000	Immediately	
			Pn716.0: bit8 inverse selection			
			0	The signal is not inverted.		
			1	The signal is inverted.		
			Pn716.1: bit9 inverse selection			
			0	The signal is not inverted.		
			1	The signal is inverted.		
			Pn716.2: bit10 inverse selection			
			0	The signal is not inverted.		
			1	The signal is inverted.		
			Pn716.3: bit11 inverse selection			
			0	The signal is not inverted.		
			1	The signal is inverted.		

No.	Index	Name	Range	Unit	Default						
Pn717	Virtual Input Port Signal Inverts 2	b0000 to b1111	-	0000	Immediately						
											
	<table border="1"> <thead> <tr> <th colspan="2">Pn717.0: bit12 inverse selection</th> </tr> </thead> <tbody> <tr> <td>0</td> <td>The signal is not inverted.</td> </tr> <tr> <td>1</td> <td>The signal is inverted.</td> </tr> </tbody> </table>					Pn717.0: bit12 inverse selection		0	The signal is not inverted.	1	The signal is inverted.
	Pn717.0: bit12 inverse selection										
	0	The signal is not inverted.									
	1	The signal is inverted.									
	<table border="1"> <thead> <tr> <th colspan="2">Pn717.1: bit13 inverse selection</th> </tr> </thead> <tbody> <tr> <td>0</td> <td>The signal is not inverted.</td> </tr> <tr> <td>1</td> <td>The signal is inverted.</td> </tr> </tbody> </table>					Pn717.1: bit13 inverse selection		0	The signal is not inverted.	1	The signal is inverted.
	Pn717.1: bit13 inverse selection										
	0	The signal is not inverted.									
	1	The signal is inverted.									
<table border="1"> <thead> <tr> <th colspan="2">Pn717.2: bit14 inverse selection</th> </tr> </thead> <tbody> <tr> <td>0</td> <td>The signal is not inverted.</td> </tr> <tr> <td>1</td> <td>The signal is inverted.</td> </tr> </tbody> </table>					Pn717.2: bit14 inverse selection		0	The signal is not inverted.	1	The signal is inverted.	
Pn717.2: bit14 inverse selection											
0	The signal is not inverted.										
1	The signal is inverted.										
<table border="1"> <thead> <tr> <th colspan="2">Pn717.3: bit15 inverse selection</th> </tr> </thead> <tbody> <tr> <td>0</td> <td>The signal is not inverted.</td> </tr> <tr> <td>1</td> <td>The signal is inverted.</td> </tr> </tbody> </table>					Pn717.3: bit15 inverse selection		0	The signal is not inverted.	1	The signal is inverted.	
Pn717.3: bit15 inverse selection											
0	The signal is not inverted.										
1	The signal is inverted.										
Pn720	Homing Method	1 to 35	-	1	Immediately						
	Mapping to the object 6098h in CiA402.										
Pn721	Speed during Search for Switch	1to0x7FFFFFFF	0.1 rpm	5000	Immediately						
	Mapping to the object 6099:01 in CiA402.										
Pn722	Speed during Search for Zero	1to0x7FFFFFFF	0.1 rpm	100	Immediately						
	Mapping to the object 6099:02 in CiA402.										
Pn723	Homing Acceleration	1to0x7FFFFFFF	0.1 rpm/s	1000000	Immediately						
	Mapping to the object 609Ah in CiA402.										
Pn724	Home Offset	-2147483648 to 2147483647	pulse	0	Immediately						
	Mapping to the object 6093-01h in CiA402.										

No.	Index	Name	Range	Unit	Default
Pn725	Bus Electronic Gear Ratio (Numerator)	1 ~1073741824	pulse	1	Immediately
	Mapping to the object 6093:01 in CiA402.				
Pn726	Bus Electronic Gear Ratio (Denominator)	1 ~1073741824	pulse	1	After restart
	Mapping to the object 6093:02 in CiA402.				
Pn728	Tool Magazine Single-turn Storage	-2147483648to 2147483647	pulse	0	Immediately
	Tool magazine origin storage, single-turn position				
Pn729	Auto Signal-step Running Tool Change	0 to 1	-	0	Immediately
	The enabled position for automatic single-step running tool change				
Pn730	Return to Nearest Tool Location Upon Power-on	0 to 1	-	0	After restart
	The enabled position for returning to the nearest position after power it on				
Pn731	Position Offset Threshold for Return to Nearest Tool Location Upon Power-on	0 to 10000	0.0001 round	1000	Immediately
	Range of tool number error is Pn737toPn731, and the disk moves to center position of the nearest tool location				
Pn732	Returning Speed to Nearest Tool Location Upon Power-on	0 to 500	rpm	100	Immediately
	The speed to return to the nearest tool location (1 arrival distance) after power on				
Pn733	Returning Acceleration to Nearest Tool Location Upon Power-on	0 to 10000	ms	200	Immediately
	The acceleration to return to the nearest tool location after power on (the time required for accelerating from 0 to 1000 revolutions)				
Pn734	Returning Deceleration to Nearest Tool Location Upon Power-on	0 to 10000	ms	200	Immediately
	The deceleration to return to the nearest tool location after power on (the time required for decelerating from 1000 revolutions to 0)				
Pn735	Number of Tool Location	1 to 30	-	20	Immediately
	-				

No.	Index	Name	Range	Unit	Default
Pn736	Tool Change Running Speed	0 to 6000	rpm	3000	Immediately
	–				
Pn737	Tool Number Error Range	0 to 10000	0.0001 round	250	Immediately
	The tool number error range, in which tool location stops and outputs tool number				
Pn738	Near Tool Running Acceleration	0 to 10000	ms	200	Immediately
	The nearest tool running acceleration (the time required for accelerating from 0 to 1000 revolutions)				
Pn739	Near Tool Running Deceleration	0 to 10000	ms	200	Immediately
	The nearest tool running deceleration (the time required for decelerating from 1000 revolutions to 0)				
Pn740	Remote Tool Running Acceleration	0 to 10000	ms	200	Immediately
	The remote tool running acceleration (the time required for accelerating from 0 to 1000 revolutions)				
Pn741	Remote Tool Running Deceleration	0 to 10000	ms	200	Immediately
	The remote tool running deceleration (the time required for decelerating from 1000 revolutions to 0)				
Pn742	Tool Change Delay	0 to 10000	ms	500	Immediately
	The time delayed in tool change				

No.	Index	Name	Range	Unit	Default
Pn800	Motor Power No.	h0000 ~ h050F	0	—	After restart
					
	Pn800.0: Motor Power No.				
	Pn800.1: Motor Power No.				
	Pn800.2: Motor Power No.				
Pn800.3: Motor Power No.					
Pn801	Motor Design Sequence	h0000 ~ h0003	0	—	After restart
					
	Pn801.0: Motor Sequence				
	0	First generation motors			
	1	Second generation motors			
	2	Third-party motors			
3	EM3A motors				
Pn801.1: Reserved					
Pn801.2: Reserved					
Pn801.3: Reserved					
Pn802	Initial Encoder Phase	0 ~ 2147483647	0	—	After restart
	—				
Pn803	Reserved	0 - 0	0	—	After restart
	Reserved				
Pn804	Motor Series	0 - 5	0	—	After restart

No.	Index	Name	Range	Unit	Default
	[0] EMJ [1] EMG [2] EML [3] EMB [4] 保留 [5] EM3A				

DRAFT

No.	Index	Name	Range	Unit	Default
Pn805	Motor Type	0 - 1	0	—	After restart
	[0] SPM [1] IPM				
Pn806	Voltage Class	0 - 1	0	—	After restart
	[0] 200V [1] 380V				
Pn807	Motor Power	1 - 50000	1	W	After restart
	—				
Pn808	Motor Temperature Sensor Type	0 - 3	0	—	After restart
	[0] N/A [1] KTY84 [2] PT1000 [3] PT100				
Pn809	Motor Derating Factor	1 - 100	1	0.01Tn	After restart
	—				
Pn810	Rated Torque	1 - 10000	1	0.01Nm	After restart
	—				
Pn811	Max. Torque	1 - 10000	1	0.01Nm	After restart
	—				
Pn812	Rated current	1 - 2000	1	0.1A	After restart
	—				
Pn813	Max. current	1 - 2000	1	0.1A	After restart
	—				
Pn814	Rated Speed	1 - 10000	1	rpm	After restart
	—				
Pn815	Max. Speed	1 - 10000	1	rpm	After restart
	—				
Pn816	Limit Speed	1 - 10000	1	rpm	After restart
	—				

No.	Index	Name	Range	Unit	Default
Pn817	a0*10000	-10000 ~ 10000	0	—	After restart
	To convert torque into the corresponding current				
Pn818	a1*10000	-2000 ~ 2000	0	—	After restart
	To convert torque into the corresponding current				
Pn819	a2*10000	-2000 ~ 2000	0	—	After restart
	To convert torque into the corresponding current				
Pn820	a3*10000	0 ~ 0	0	—	After restart
	To convert torque into the corresponding current				
Pn821	a4*10000	0 ~ 0	0	—	After restart
	To convert torque into the corresponding current				
Pn822	b0*10000	-10000 ~ 10000	0	—	After restart
	To convert current into the corresponding torque				
Pn823	b1*10000	-2000 ~ 2000	0	—	After restart
	To convert current into the corresponding torque				
Pn824	b2*10000	-2000 ~ 2000	0	—	After restart
	To convert current into the corresponding torque				
Pn825	b3*10000	0 ~ 0	0	—	After restart
	To convert current into the corresponding torque				
Pn826	b4*10000	0 ~ 0	0	—	After restart
	To convert current into the corresponding torque				
Pn827	Back Electromotive Force Coefficient Ke	1000 ~ 5000	1000	0.01V/Krpm	After restart
	—				
Pn828	Phase Resistance Rs	0 ~ 900000	0	0.001Ω	After restart
	—				
Pn829	Ld	0 ~ 5000	0	0.1mH	After restart
	—				

No.	Index	Name	Range	Unit	Default
Pn830	Lq	0 - 5000	0	0.1mH	After restart
	—				
Pn831	Motor Inertia	0 - 100000	0	1e-8Kgm ²	After restart
	—				
Pn832	Pair of Poles	0 - 20	0	—	After restart
	—				
Pn833	Electrical Time Constant te	0 - 10000	0	0.01ms	After restart
	—				
Pn834	Mechanical Time Constant tm	0 - 10000	0	0.01ms	After restart
	—				
Pn835	Thermal Time Constant th	0 - 10000	0	0.01ms	After restart
	—				
Pn836	Thermal Model Parameter Tp[0]*10000	0 - 0	0	—	After restart
	For motor overheating protection and alarm judgement.				
Pn837	Thermal Model Parameter Tp[1]*10000	0 - 0	0	—	After restart
	For motor overheating protection and alarm judgement.				
Pn838	Thermal Model Parameter Tp[2]*10000	0 - 0	0	—	After restart
	For motor overheating protection and alarm judgement.				
Pn839	Thermal Model Parameter Tp[3]*10000	0 - 0	0	—	After restart
	For motor overheating protection and alarm judgement.				
Pn840	Thermal Model Parameter Tp[4]*10000	0 - 0	0	—	After restart
	For motor overheating protection and alarm judgement.				
Pn841	Motor Overload Curve Factor k[0]*10000	0 - 100000	0	—	After restart
	For motor overload protection and alarm judgement.				
Pn842	Motor Overload Curve Factor k[1]*10000	0 - 100000	0	—	After restart
	For motor overload protection and alarm judgement.				

No.	Index	Name	Range	Unit	Default
Pn843	Motor Overload Curve Factor k[2]*10000	0 - 100000	0	—	After restart
	For motor overload protection and alarm judgement.				
Pn844	Motor Overload Curve Factor k[3]*10000	0 - 0	0	—	After restart
	For motor overload protection and alarm judgement.				
Pn845	Motor Overload Curve Factor k[4]*10000	0 - 0	0	—	After restart
	For motor overload protection and alarm judgement.				
Pn846	Motor Oil Seal Property	0 - 1	0	—	After restart
	[0] Without oil seal [1] With oil seal				
Pn875	Encoder Type	h0000 - h000E	0	—	After restart

No.	Index	Name	Range	Unit	Default																																
																																					
		<table border="1"> <thead> <tr> <th colspan="2">Pn875.0: Encoder Type</th> </tr> </thead> <tbody> <tr> <td>0</td> <td>–</td> </tr> <tr> <td>1</td> <td>–</td> </tr> <tr> <td>2</td> <td>–</td> </tr> <tr> <td>3</td> <td>17-bit multi-turn, Tamagawa</td> </tr> <tr> <td>4</td> <td>17-bit single-turn, Tamagawa</td> </tr> <tr> <td>5</td> <td>Reserved (resolver)</td> </tr> <tr> <td>6</td> <td>Reserved</td> </tr> <tr> <td>7</td> <td>20-bit multi-turn, Nikon</td> </tr> <tr> <td>8</td> <td>20-bit single-turn, Nikon</td> </tr> <tr> <td>9</td> <td>20-bit multi-turn, Tamagawa</td> </tr> <tr> <td>A</td> <td>19-bit multi-turn, Endat</td> </tr> <tr> <td>B</td> <td>20-bit single-turn, Biss</td> </tr> <tr> <td>C</td> <td>23-bit multi-turn, Tamagawa</td> </tr> <tr> <td>D</td> <td>20-bit single-turn, Tamagawa</td> </tr> <tr> <td>E</td> <td>23-bit multi-turn, Nikon</td> </tr> </tbody> </table>				Pn875.0: Encoder Type		0	–	1	–	2	–	3	17-bit multi-turn, Tamagawa	4	17-bit single-turn, Tamagawa	5	Reserved (resolver)	6	Reserved	7	20-bit multi-turn, Nikon	8	20-bit single-turn, Nikon	9	20-bit multi-turn, Tamagawa	A	19-bit multi-turn, Endat	B	20-bit single-turn, Biss	C	23-bit multi-turn, Tamagawa	D	20-bit single-turn, Tamagawa	E	23-bit multi-turn, Nikon
Pn875.0: Encoder Type																																					
0	–																																				
1	–																																				
2	–																																				
3	17-bit multi-turn, Tamagawa																																				
4	17-bit single-turn, Tamagawa																																				
5	Reserved (resolver)																																				
6	Reserved																																				
7	20-bit multi-turn, Nikon																																				
8	20-bit single-turn, Nikon																																				
9	20-bit multi-turn, Tamagawa																																				
A	19-bit multi-turn, Endat																																				
B	20-bit single-turn, Biss																																				
C	23-bit multi-turn, Tamagawa																																				
D	20-bit single-turn, Tamagawa																																				
E	23-bit multi-turn, Nikon																																				
		Pn875.1: Encoder Type, as above																																			
		Pn875.2: Reserved																																			
		Pn875.3: Reserved																																			

No.	Index	Name	Range	Unit	Default						
Pn876	Reserved	0	0	—	After restart						
	—										
Pn877	Encoder Type	0 ~ 4	0	—	After restart						
	[0] Reserved [1] Tamagawa [2] Nikon [3] Endat [4] Biss-C										
Pn878	Encoder Function Type	0 ~ 1	0								
	[0] Incremental [1] Absolute										
Pn880	Number of Bits of Encoder Resolution Used in the Program	0 ~ 24	0	—	After restart						
Pn881	Encoder Multi-turn Information Resolution	0 ~ 20	0	—	After restart						
Pn885	Drive Power Level	h0000 ~ h020F	0	—	After restart						
											
	<table border="1" style="width: 100%; border-collapse: collapse;"> <tr> <td colspan="2" style="background-color: #e6f2ff;">Pn885.0: Drive Power Level</td> </tr> <tr> <td style="text-align: center;">0</td> <td>200W</td> </tr> <tr> <td style="text-align: center;">1</td> <td>400W</td> </tr> </table>					Pn885.0: Drive Power Level		0	200W	1	400W
	Pn885.0: Drive Power Level										
	0	200W									
	1	400W									
	<table border="1" style="width: 100%; border-collapse: collapse;"> <tr> <td colspan="2" style="background-color: #e6f2ff;">Pn885.1: Drive Power Level</td> </tr> <tr> <td style="text-align: center;">0</td> <td>200W</td> </tr> <tr> <td style="text-align: center;">1</td> <td>400W</td> </tr> </table>					Pn885.1: Drive Power Level		0	200W	1	400W
	Pn885.1: Drive Power Level										
	0	200W									
	1	400W									
<table border="1" style="width: 100%; border-collapse: collapse;"> <tr> <td colspan="2" style="background-color: #e6f2ff;">Pn885.2: Drive Type</td> </tr> <tr> <td style="text-align: center;">0</td> <td>F version</td> </tr> <tr> <td style="text-align: center;">1</td> <td></td> </tr> </table>					Pn885.2: Drive Type		0	F version	1		
Pn885.2: Drive Type											
0	F version										
1											
Pn885.3: Reserved											
<table border="1" style="width: 100%; border-collapse: collapse;"> <tr> <td colspan="2" style="background-color: #e6f2ff;">Pn885.0: Drive Power Level</td> </tr> <tr> <td style="text-align: center;">0</td> <td>200W</td> </tr> <tr> <td style="text-align: center;">1</td> <td>400W</td> </tr> </table>					Pn885.0: Drive Power Level		0	200W	1	400W	
Pn885.0: Drive Power Level											
0	200W										
1	400W										
<table border="1" style="width: 100%; border-collapse: collapse;"> <tr> <td colspan="2" style="background-color: #e6f2ff;">Pn885.1: Drive Power Level</td> </tr> <tr> <td style="text-align: center;">0</td> <td>200W</td> </tr> <tr> <td style="text-align: center;">1</td> <td>400W</td> </tr> </table>					Pn885.1: Drive Power Level		0	200W	1	400W	
Pn885.1: Drive Power Level											
0	200W										
1	400W										
<table border="1" style="width: 100%; border-collapse: collapse;"> <tr> <td colspan="2" style="background-color: #e6f2ff;">Pn885.2: Drive Type</td> </tr> <tr> <td style="text-align: center;">0</td> <td>F version</td> </tr> <tr> <td style="text-align: center;">1</td> <td></td> </tr> </table>					Pn885.2: Drive Type		0	F version	1		
Pn885.2: Drive Type											
0	F version										
1											
Pn885.3: Reserved											
Pn895	Selection of Motor Phases and Parameter Zones	b0000 ~ b1111	0	—	After restart						

No.	Index	Name	Range	Unit	Default
					
		Pn895.0: A58 Alarm Mask Bit			
	0	Enable the A58 alarm and use the phase information in the EEROM 1 zone			
	1	Mask the A58 alarm and use the special information set in the Pn parameter as the encoder phase information			
		Pn895.1: Select A59 Alarm Mask Bit for Phase Information			
	0	Enable the A59 alarm and use the phase information in the EEROM 1 zone			
	1	Mask the A59 alarm and use the special information set in the Pn parameter as the encoder phase information			
		Pn895.2: Select A42 Alarm Mask Bit for Motor Parameter Information			
	0	The A42 alarm is not masked, and drive-motor power mismatch operation is not supported.			
	1	The A42 alarm is masked, and drive-motor power mismatch operation is supported.			
		Pn895.3: Type of Motor Manufacturer			
	0	ESTUN Motors			
	1	Third-party Motors			

No.	Index	Name	Range	Unit	Default						
Pn914	Asynchronous Drag Uq Amplitude	0 ~ 1000	100	%	After restart						
	The Voltage scale in thousands (%)										
Pn915	Asynchronous Drag Frequency	1 ~ 100	30	—	After restart						
	—										
Pn916	Current Loop Bandwidth Setpoint	800 ~ 1200	850	Hz	After restart						
	—										
Pn917	Percentage of Deadband Compensation	0 ~ 100	0	%	After restart						
	—										
Pn920	Binary Bit Parameter	b0000 ~ b0011	0000	—	After restart						
											
	<table border="1" style="width: 100%; border-collapse: collapse;"> <tr> <td colspan="2" style="background-color: #e6f2ff;">Pn920.0: Test Mode Enable Switch</td> </tr> <tr> <td style="text-align: center;">0</td> <td>Ordinary mode</td> </tr> <tr> <td style="text-align: center;">1</td> <td>Test mode</td> </tr> </table>					Pn920.0: Test Mode Enable Switch		0	Ordinary mode	1	Test mode
	Pn920.0: Test Mode Enable Switch										
	0	Ordinary mode									
	1	Test mode									
	<table border="1" style="width: 100%; border-collapse: collapse;"> <tr> <td colspan="2" style="background-color: #e6f2ff;">Pn920.1: Analog Power-Up Function Enable</td> </tr> <tr> <td style="text-align: center;">0</td> <td>Mask the analogue power-up function</td> </tr> <tr> <td style="text-align: center;">1</td> <td>Analog power-up function enabled</td> </tr> </table>					Pn920.1: Analog Power-Up Function Enable		0	Mask the analogue power-up function	1	Analog power-up function enabled
	Pn920.1: Analog Power-Up Function Enable										
	0	Mask the analogue power-up function									
	1	Analog power-up function enabled									
Pn920.2: Reserved											
Pn920.3: Reserved											
<table border="1" style="width: 100%; border-collapse: collapse;"> <tr> <td colspan="2" style="background-color: #e6f2ff;">Pn920.0: Test Mode Enable Switch</td> </tr> <tr> <td style="text-align: center;">0</td> <td>Ordinary mode</td> </tr> <tr> <td style="text-align: center;">1</td> <td>Test mode</td> </tr> </table>					Pn920.0: Test Mode Enable Switch		0	Ordinary mode	1	Test mode	
Pn920.0: Test Mode Enable Switch											
0	Ordinary mode										
1	Test mode										
<table border="1" style="width: 100%; border-collapse: collapse;"> <tr> <td colspan="2" style="background-color: #e6f2ff;">Pn920.1: Analog Power-Up Function Enable</td> </tr> <tr> <td style="text-align: center;">0</td> <td>Mask the analogue power-up function</td> </tr> <tr> <td style="text-align: center;">1</td> <td>Analog power-up function enabled</td> </tr> </table>					Pn920.1: Analog Power-Up Function Enable		0	Mask the analogue power-up function	1	Analog power-up function enabled	
Pn920.1: Analog Power-Up Function Enable											
0	Mask the analogue power-up function										
1	Analog power-up function enabled										
Pn920.2: Reserved											
Pn920.3: Reserved											
Pn921	Hexadecimal Bit Parameter	h0000 ~ h0005	0000	—	After restart						

No.	Index	Name	Range	Unit	Default														
																			
		<table border="1"> <tr> <td colspan="2">Pn921.0: Test Mode Selection</td> </tr> <tr> <td>0</td> <td>Position loop frequency domain</td> </tr> <tr> <td>1</td> <td>Velocity loop frequency domain</td> </tr> <tr> <td>2</td> <td>Current loop frequency domain</td> </tr> <tr> <td>3</td> <td>Current-loop step</td> </tr> <tr> <td>4</td> <td>Velocity loop sweep</td> </tr> <tr> <td>5</td> <td>Current loop sweep</td> </tr> </table>				Pn921.0: Test Mode Selection		0	Position loop frequency domain	1	Velocity loop frequency domain	2	Current loop frequency domain	3	Current-loop step	4	Velocity loop sweep	5	Current loop sweep
Pn921.0: Test Mode Selection																			
0	Position loop frequency domain																		
1	Velocity loop frequency domain																		
2	Current loop frequency domain																		
3	Current-loop step																		
4	Velocity loop sweep																		
5	Current loop sweep																		
		Pn921.1: Reserved																	
		Pn921.2: Reserved																	
		Pn921.3: Reserved																	

DRAFT

No.	Index	Name	Range	Unit	Default
Pn922	Current Loop Step Test Id % Given	0 - 300	0	%	—
	Rated Percentage (%)				
Pn923	Current Loop Step Test Iq % Given	0 - 300	0	%	After restart
	Rated Percentage (%)				
Pn924	Current Given Time	0 - 30000	1000	62.5us	After restart
	Reserved				
Pn925	Iq % of Given Offset of Current Loop Frequency Response Test	0 - 500	45	%	After restart
	—				
Pn926	Iq % of Given Amplitude of Current Loop Frequency Response Test	1 - 500	30	%	After restart
	—				
Pn927	Reserved	0-0	0	—	After restart
	Reserved				
Pn928	Given Offset for Velocity Loop Frequency Response Test Speed	0 - 1000	500	rpm	After restart
	—				
Pn929	Given Amplitude for Velocity Loop Frequency Response Test	1 - 1000	30	rpm	After restart
	—				
Pn930	Reserved	0-0	0	—	After restart
	Reserved				
Pn931	DA Output Voltage Amplitude in Frequency Response Test Mode	1 - 50	5	0.1V	After restart
	—				
Pn932	Sweep Frequency	1 - 3000	50	Hz	After restart
	—				
Pn933	Reserved	0-0	0	—	After restart
	Reserved				
Pn934	Reserved	0-0	0	—	After restart
	Reserved				
Pn935	Speed Ratio per Volt in Position Loop Frequency Domain Test	1 - 90000	10	—	After restart

No.	Index	Name	Range	Unit	Default
	The higher the value, the higher the speed during the position loop test.				

DRAFT

No.	Index	Name	Range	Unit	Default
Pn938	Reserved	0-0	0	—	—
	Reserved				
Pn939	STO Function Masking	0 ~ 1	0	—	After restart
	[0] Not mask STO [1] Mask STO				
Pn940	Interrupt Cycle Time Setting	0 ~ 1	1	—	After restart
	[0] 100us interrupt cycle [1] 125us interrupt cycle				
Pn941	EM3A Motor Field Weakening Enable Switch	0 ~ 1	1	—	After restart
	[0] Shield the Field Weakening function [1] Enable the Field Weakening function				
Pn942	Field Weakening PI regulator, kp	0 - 9000	20	0.01	After restart
	—				
Pn943	Field Weakening PI regulator, ki	0 - 9000	4000	0.1	After restart
	—				
Pn944	Field Weakening Idr Max Limit %	0 - 100	60	%	After restart
	Max. Limit Value of Field Weakening Idr %				
Pn945	Current Loop Control Mode	0 - 1	0	—	After restart
	[0] Voltage feed-forward decoupling control [1] Complex vector control				
Pn946	Magnetically Programmed Motor Sets Communication Frequency Enable ON Switch	0- 1	1	—	After restart
	Magnetically programmed motor sets the communication frequency to enable the on switch				
Pn949	Motor Torque Limit Bias	-50 ~ 100	20	%	After restart
	Percentage of motor torque limiting bias				
Pn951	Enable Tz	0 ~ 1	1	—	After restart
	[0] Shield Tz [1] Enable Tz				
Pn952	Amplification of Motor Tmax and Pn401/402	100 ~ 200	100	0.01	After restart

No.	Index	Name	Range	Unit	Default
	The amplification of the motor Tmax and of Pn401/402 is used to increase the motor output torque when the Kt calibration is inaccurate.				

DRAFT

No.	Index	Name	Range	Unit	Default
Pn953	Amplify Motor I _{max}	100 ~ 150	105	0.01	
	Amplify the motor I _{max}				
Pn954	Alarm Self-test	0 ~ 6	0	—	After restart
	To debug variables. Used to simulate alarms and warnings during alarm self-test. [0] No alarm; [x] Trigger A.Fx				
Pn955	Busbar Voltage Correction	-30 ~ 30	0	V	After restart
	The bus voltage value calculated from the sampling plus this value is the final voltage value used.				
Pn957	ePWM Forced Sync Enabling Bit in EC Mode	0~1	1	—	After restart
	Forced synchronization enable bit of ePWM timer and EC distribution clock [0] No synchronization [1] Forced synchronization (default)				
Pn960	Alarm Mask Register	b0000 ~ b1111	b0000	—	After restart
Pn960	Alarm Mask Register	b0000 ~ b1111	b0000	—	After restart
					
	Pn960.0: A37				
	0 Not masked				
	1 Masked				
	Pn960.1: A14				
	0 Not masked				
	1 Masked				
	Pn960.2: A13				
	0 Not masked				
	1 Masked				
	Pn960.3:A20				
	0 Not masked				
	1 Masked				
	Alarm Mask Register	b0000 ~ b1111	b0000	—	重启



No.	Index	Name	Range	Unit	Default
Pn961					
	Pn961.0: A81				
	0	Not masked			
	1	Masked			
	Pn961.1: A04				
	0	Not masked			
	1	Masked			
	Pn961.2: A1C				
	0	Not masked			
	1	Masked			
	Pn961.3:A11				
	0	Not masked			
	1	Masked			

DRAFT

No.	Index	Name	Range	Unit	Default	
Pn962	Alarm Mask Register		b0000 ~ b1111	0000	—	重启
						
	Pn962.0: A18					
			0	Not masked		
			1	Masked		
	Pn962.1: A19					
			0	Not masked		
			1	Masked		
	Pn962.2: A23					
			0	Not masked		
			1	Masked		
	Pn962.3:A16					
			0	Not masked		
			1	Masked		
		Alarm Mask Register	b0000 ~ b1111	0000	—	重启

No.	Index	Name	Range	Unit	Default
Pn963					
	Pn963.0: A24				
	0	Not masked			
	1	Masked			
	Pn963.1: A1A				
	0	Not masked			
	1	Masked			
	Pn963.2: A1B				
	0	Not masked			
	1	Masked			
	Pn963.3:A1F				
	0	Not masked			
	1	Masked			

DRAFT

No.	Index	Name	Range	Unit	Default																			
Pn964	Alarm Mask Register		b0000 ~ b1111	0000	—	重启																		
																								
	<table border="1" style="width: 100%; border-collapse: collapse;"> <tr> <td colspan="6" style="background-color: #e6f2ff;">Pn964.0: A36 Mask Bit (NEXT52 Power Failure)</td> </tr> <tr> <td style="width: 5%; text-align: center;">0</td> <td colspan="5">Not masked</td> </tr> <tr> <td style="text-align: center;">1</td> <td colspan="5">Masked</td> </tr> </table>						Pn964.0: A36 Mask Bit (NEXT52 Power Failure)						0	Not masked					1	Masked				
	Pn964.0: A36 Mask Bit (NEXT52 Power Failure)																							
	0	Not masked																						
	1	Masked																						
	<table border="1" style="width: 100%; border-collapse: collapse;"> <tr> <td colspan="6" style="background-color: #e6f2ff;">Pn964.1: A.35 Mask Bit (Control Panel Temperature Sensor Disconnected)</td> </tr> <tr> <td style="width: 5%; text-align: center;">0</td> <td colspan="5">Not masked</td> </tr> <tr> <td style="text-align: center;">1</td> <td colspan="5">Masked</td> </tr> </table>						Pn964.1: A.35 Mask Bit (Control Panel Temperature Sensor Disconnected)						0	Not masked					1	Masked				
	Pn964.1: A.35 Mask Bit (Control Panel Temperature Sensor Disconnected)																							
	0	Not masked																						
	1	Masked																						
	<table border="1" style="width: 100%; border-collapse: collapse;"> <tr> <td colspan="6" style="background-color: #e6f2ff;">Pn964.2: A.1d Mask Bit (NTC Disconnected)</td> </tr> <tr> <td style="width: 5%; text-align: center;">0</td> <td colspan="5">Not masked</td> </tr> <tr> <td style="text-align: center;">1</td> <td colspan="5">Masked</td> </tr> </table>						Pn964.2: A.1d Mask Bit (NTC Disconnected)						0	Not masked					1	Masked				
	Pn964.2: A.1d Mask Bit (NTC Disconnected)																							
	0	Not masked																						
	1	Masked																						
	<table border="1" style="width: 100%; border-collapse: collapse;"> <tr> <td colspan="6" style="background-color: #e6f2ff;">Pn964.3: A.34 Mask Bit (Control Panel Temperature Sensor Disconnected)</td> </tr> <tr> <td style="width: 5%; text-align: center;">0</td> <td colspan="5">Not masked</td> </tr> <tr> <td style="text-align: center;">1</td> <td colspan="5">Masked</td> </tr> </table>						Pn964.3: A.34 Mask Bit (Control Panel Temperature Sensor Disconnected)						0	Not masked					1	Masked				
Pn964.3: A.34 Mask Bit (Control Panel Temperature Sensor Disconnected)																								
0	Not masked																							
1	Masked																							
Pn965	Alarm Mask Register		b0000 ~ b001	0000	—	重启																		
																								
	<table border="1" style="width: 100%; border-collapse: collapse;"> <tr> <td colspan="6" style="background-color: #e6f2ff;">Pn965.0: Mask Bit (Encoder Position Jump Alarm)</td> </tr> <tr> <td style="width: 5%; text-align: center;">0</td> <td colspan="5">Not masked</td> </tr> <tr> <td style="text-align: center;">1</td> <td colspan="5">Masked</td> </tr> </table>						Pn965.0: Mask Bit (Encoder Position Jump Alarm)						0	Not masked					1	Masked				
	Pn965.0: Mask Bit (Encoder Position Jump Alarm)																							
	0	Not masked																						
	1	Masked																						
Pn965.1: Reserved																								
Pn965.2: Reserved																								
Pn965.3: Reserved																								
PnA00	PCP Control Position Pulse 0	-2000000000 to 2000000000	1P	0	Immediately																			

No.	Index	Name	Range	Unit	Default
	The position pulse reference corresponding to PCP control contact 0				
PnA01	PCP Control Position Pulse 1	-2000000000 to 2000000000	1P	0	Immediately
	The position pulse reference corresponding to PCP control contact 1				
PnA02	PCP Control Position Pulse 2	-2000000000 to 2000000000	1P	0	Immediately
	The position pulse reference corresponding to PCP control contact 2				
PnA03	PCP Control Position Pulse 3	-2000000000 to 2000000000	1P	0	Immediately
	The position pulse reference corresponding to PCP control contact 3				
PnA04	PCP Control Position Pulse 4	-2000000000 to 2000000000	1P	0	Immediately
	The position pulse reference corresponding to PCP control contact 4				
PnA05	PCP Control Position Pulse 5	-2000000000 to 2000000000	1P	0	Immediately
	The position pulse reference corresponding to PCP control contact 5				
PnA06	PCP Control Position Pulse 6	-2000000000 to 2000000000	1P	0	Immediately
	The position pulse reference corresponding to PCP control contact 6				
PnA07	PCP Control Position Pulse 7	-2000000000 to 2000000000	1P	0	Immediately
	The position pulse reference corresponding to PCP control contact 7				
PnA08	PCP Control Position Pulse 8	-2000000000 to 2000000000	1P	0	Immediately
	The position pulse reference corresponding to PCP control contact 8				
PnA09	PCP Control Position Pulse 9	-2000000000 to 2000000000	1P	0	Immediately
	The position pulse reference corresponding to PCP control contact 9				
PnA10	PCP Control Position Pulse 10	-2000000000 to 2000000000	1P	0	Immediately
	The position pulse reference corresponding to PCP control contact 10				

No.	Index	Name	Range	Unit	Default
PnA11	PCP Control Position Pulse 11	-2000000000 to 2000000000	1P	0	Immediately
	The position pulse reference corresponding to PCP control contact 11				
PnA12	PCP Control Position Pulse 12	-2000000000 to 2000000000	1P	0	Immediately
	The position pulse reference corresponding to PCP control contact 12				
PnA13	PCP Control Position Pulse 13	-2000000000 to 2000000000	1P	0	Immediately
	The position pulse reference corresponding to PCP control contact 13				
PnA14	PCP Control Position Pulse 14	-2000000000 to 2000000000	1P	0	Immediately
	The position pulse reference corresponding to PCP control contact 14				
PnA15	PCP Control Position Pulse 15	-2000000000 to 2000000000	1P	0	Immediately
	The position pulse reference corresponding to PCP control contact 15				
PnA16	PCP Control Position Pulse 16	-2000000000 to 2000000000	1P	0	Immediately
	The position pulse reference corresponding to PCP control contact 16				
PnA17	PCP Control Position Pulse 17	-2000000000 to 2000000000	1P	0	Immediately
	The position pulse reference corresponding to PCP control contact 17				
PnA18	PCP Control Position Pulse 18	-2000000000 to 2000000000	1P	0	Immediately
	The position pulse reference corresponding to PCP control contact 18				
PnA19	PCP Control Position Pulse 19	-2000000000 to 2000000000	1P	0	Immediately
	The position pulse reference corresponding to PCP control contact 19				
PnA20	PCP Control Position Pulse 20	-2000000000 to 2000000000	1P	0	Immediately
	The position pulse reference corresponding to PCP control contact 20				
PnA21	PCP Control Position Pulse 21	-2000000000 to 2000000000	1P	0	Immediately
	The position pulse reference corresponding to PCP control contact 21				

No.	Index	Name	Range	Unit	Default
PnA22	PCP Control Position Pulse 22	-2000000000 to 2000000000	1P	0	Immediately
	The position pulse reference corresponding to PCP control contact 22				
PnA23	PCP Control Position Pulse 23	-2000000000 to 2000000000	1P	0	Immediately
	The position pulse reference corresponding to PCP control contact 23				
PnA24	PCP Control Position Pulse 24	-2000000000 to 2000000000	1P	0	Immediately
	The position pulse reference corresponding to PCP control contact 24				
PnA25	PCP Control Position Pulse 25	-2000000000 to 2000000000	1P	0	Immediately
	The position pulse reference corresponding to PCP control contact 25				
PnA26	PCP Control Position Pulse 26	-2000000000 to 2000000000	1P	0	Immediately
	The position pulse reference corresponding to PCP control contact 26				
PnA27	PCP Control Position Pulse 27	-2000000000 to 2000000000	1P	0	Immediately
	The position pulse reference corresponding to PCP control contact 27				
PnA28	PCP Control Position Pulse 28	-2000000000 to 2000000000	1P	0	Immediately
	The position pulse reference corresponding to PCP control contact 28				
PnA29	PCP Control Position Pulse 29	-2000000000 to 2000000000	1P	0	Immediately
	The position pulse reference corresponding to PCP control contact 29				
PnA30	PCP Control Position Pulse 30	-2000000000 to 2000000000	1P	0	Immediately
	The position pulse reference corresponding to PCP control contact 30				
PnA31	PCP Control Position Pulse 31	-2000000000 to 2000000000	1P	0	Immediately
	The position pulse reference corresponding to PCP control contact 31				
PnA32	PCP Control Position Speed 0	0 to 6000	rpm	500	Immediately
	The speed reference corresponding to PCP control contact 0				

No.	Index	Name	Range	Unit	Default
PnA33	PCP Control Position Speed 1	0 to 6000	rpm	500	Immediately
	The speed reference corresponding to PCP control contact 1				
PnA34	PCP Control Position Speed 2	0 to 6000	rpm	500	Immediately
	The speed reference corresponding to PCP control contact 2				
PnA35	PCP Control Position Speed 3	0 to 6000	rpm	500	Immediately
	The speed reference corresponding to PCP control contact 3				
PnA36	PCP Control Position Speed 4	0 to 6000	rpm	500	Immediately
	The speed reference corresponding to PCP control contact 4				
PnA37	PCP Control Position Speed 5	0 to 6000	rpm	500	Immediately
	The speed reference corresponding to PCP control contact 5				
PnA38	PCP Control Position Speed 6	0 to 6000	rpm	500	Immediately
	The speed reference corresponding to PCP control contact 6				
PnA39	PCP Control Position Speed 7	0 to 6000	rpm	500	Immediately
	The speed reference corresponding to PCP control contact 7				
PnA40	PCP Control Position Speed 8	0 to 6000	rpm	500	Immediately
	The speed reference corresponding to PCP control contact 8				
PnA41	PCP Control Position Speed 9	0 to 6000	rpm	500	Immediately
	The speed reference corresponding to PCP control contact 9				
PnA42	PCP Control Position Speed 10	0 to 6000	rpm	500	Immediately
	The speed reference corresponding to PCP control contact 10				
PnA43	PCP Control Position Speed 11	0 to 6000	rpm	500	Immediately
	The speed reference corresponding to PCP control contact 11				
PnA44	PCP Control Position Speed 12	0 to 6000	rpm	500	Immediately
	The speed reference corresponding to PCP control contact 12				
PnA45	PCP Control Position Speed 13	0 to 6000	rpm	500	Immediately
	The speed reference corresponding to PCP control contact 13				

No.	Index	Name	Range	Unit	Default
PnA46	PCP Control Position Speed 14	0 to 6000	rpm	500	Immediately
	The speed reference corresponding to PCP control contact 14				
PnA47	PCP Control Position Speed 15	0 to 6000	rpm	500	Immediately
	The speed reference corresponding to PCP control contact 15				
PnA48	PCP Control Position Speed 16	0 to 6000	rpm	500	Immediately
	The speed reference corresponding to PCP control contact 16				
PnA49	PCP Control Position Speed 17	0 to 6000	rpm	500	Immediately
	The speed reference corresponding to PCP control contact 17				
PnA50	PCP Control Position Speed 18	0 to 6000	rpm	500	Immediately
	The speed reference corresponding to PCP control contact 18				
PnA51	PCP Control Position Speed 19	0 to 6000	rpm	500	Immediately
	The speed reference corresponding to PCP control contact 19				
PnA52	PCP Control Position Speed 20	0 to 6000	rpm	500	Immediately
	The speed reference corresponding to PCP control contact 20				
PnA53	PCP Control Position Speed 21	0 to 6000	rpm	500	Immediately
	The speed reference corresponding to PCP control contact 21				
PnA54	PCP Control Position Speed 22	0 to 6000	rpm	500	Immediately
	The speed reference corresponding to PCP control contact 22				
PnA55	PCP Control Position Speed 23	0 to 6000	rpm	500	Immediately
	The speed reference corresponding to PCP control contact 23				
PnA56	PCP Control Position Speed 24	0 to 6000	rpm	500	Immediately
	The speed reference corresponding to PCP control contact 24				
PnA57	PCP Control Position Speed 25	0 to 6000	rpm	500	Immediately
	The speed reference corresponding to PCP control contact 25				
PnA58	PCP Control Position Speed 26	0 to 6000	rpm	500	Immediately
	The speed reference corresponding to PCP control contact 26				

No.	Index	Name	Range	Unit	Default
PnA59	PCP Control Position Speed 27	0 to 6000	rpm	500	Immediately
	The speed reference corresponding to PCP control contact 27				
PnA60	PCP Control Position Speed 28	0 to 6000	rpm	500	Immediately
	The speed reference corresponding to PCP control contact 28				
PnA61	PCP Control Position Speed 29	0 to 6000	rpm	500	Immediately
	The speed reference corresponding to PCP control contact 29				
PnA62	PCP Control Position Speed 30	0 to 6000	rpm	500	Immediately
	The speed reference corresponding to PCP control contact 30				
PnA63	PCP Control Position Speed 31	0 to 6000	rpm	500	Immediately
	The speed reference corresponding to PCP control contact 31				
PnA64	PCP Control Contact Attribute 0	h0000 to h1112	–	0	Immediately
	The attribute corresponding to PCP control contact 0				
PnA65	PCP Control Contact Attribute 1	h0000 to h1112	–	0	Immediately
	The attribute corresponding to PCP control contact 1				
PnA66	PCP Control Contact Attribute 2	h0000 to h1112	–	0	Immediately
	The attribute corresponding to PCP control contact 2				
PnA67	PCP Control Contact Attribute 3	h0000 to h1112	–	0	Immediately
	The attribute corresponding to PCP control contact 3				
PnA68	PCP Control Contact Attribute 4	h0000 to h1112	–	0	Immediately
	The attribute corresponding to PCP control contact 4				
PnA69	PCP Control Contact Attribute 5	h0000 to h1112	–	0	Immediately
	The attribute corresponding to PCP control contact 5				
PnA70	PCP Control Contact Attribute 6	h0000 to h1112	–	0	Immediately
	The attribute corresponding to PCP control contact 6				

No.	Index	Name	Range	Unit	Default
PnA71	PCP Control Contact Attribute 7	h0000 to h1112	–	0	Immediately
	The attribute corresponding to PCP control contact 7				
PnA72	PCP Control Contact Attribute 8	h0000 to h1112	–	0	Immediately
	The attribute corresponding to PCP control contact 8				
PnA73	PCP Control Contact Attribute 9	h0000 to h1112	–	0	Immediately
	The attribute corresponding to PCP control contact 9				
PnA74	PCP Control Contact Attribute 10	h0000 to h1112	–	0	Immediately
	The attribute corresponding to PCP control contact 10				
PnA75	PCP Control Contact Attribute 11	h0000 to h1112	–	0	Immediately
	The attribute corresponding to PCP control contact 11				
PnA76	PCP Control Contact Attribute 12	h0000 to h1112	–	0	Immediately
	The attribute corresponding to PCP control contact 12				
PnA77	PCP Control Contact Attribute 13	h0000 to h1112	–	0	Immediately
	The attribute corresponding to PCP control contact 13				
PnA78	PCP Control Contact Attribute 14	h0000 to h1112	–	0	Immediately
	The attribute corresponding to PCP control contact 14				
PnA79	PCP Control Contact Attribute 15	h0000 to h1112	–	0	Immediately
	The attribute corresponding to PCP control contact 15				
PnA80	PCP Control Contact Attribute 16	h0000 to h1112	–	0	Immediately
	The attribute corresponding to PCP control contact 16				
PnA81	PCP Control Contact Attribute 17	h0000 to h1112	–	0	Immediately
	The attribute corresponding to PCP control contact 17				

No.	Index	Name	Range	Unit	Default
PnA82	PCP Control Contact Attribute 18	h0000 to h1112	–	0	Immediately
	The attribute corresponding to PCP control contact 18				
PnA83	PCP Control Contact Attribute 19	h0000 to h1112	–	0	Immediately
	The attribute corresponding to PCP control contact 19				
PnA84	PCP Control Contact Attribute 20	h0000 to h1112	–	0	Immediately
	The attribute corresponding to PCP control contact 20				
PnA85	PCP Control Contact Attribute 21	h0000 to h1112	–	0	Immediately
	The attribute corresponding to PCP control contact 21				
PnA86	PCP Control Contact Attribute 22	h0000 to h1112	–	0	Immediately
	The attribute corresponding to PCP control contact 22				
PnA87	PCP Control Contact Attribute 23	h0000 to h1112	–	0	Immediately
	The attribute corresponding to PCP control contact 23				
PnA88	PCP Control Contact Attribute 24	h0000 to h1112	–	0	Immediately
	The attribute corresponding to PCP control contact 24				
PnA89	PCP Control Contact Attribute 25	h0000 to h1112	–	0	Immediately
	The attribute corresponding to PCP control contact 25				
PnA90	PCP Control Contact Attribute 26	h0000 to h1112	–	0	Immediately
	The attribute corresponding to PCP control contact 26				
PnA91	PCP Control Contact Attribute 27	h0000 to h1112	–	0	Immediately
	The attribute corresponding to PCP control contact 27				
PnA92	PCP Control Contact Attribute 28	h0000 to h1112	–	0	Immediately
	The attribute corresponding to PCP control contact 28				

No.	Index	Name	Range	Unit	Default
PnA93	PCP Control Contact Attribute 29	h0000 to h1112	–	0	Immediately
	The attribute corresponding to PCP control contact 29				
PnA94	PCP Control Contact Attribute 30	h0000 to h1112	–	0	Immediately
	The attribute corresponding to PCP control contact 30				
PnA95	PCP Control Contact Attribute 31	h0000 to h1112	–	0	Immediately
	The attribute corresponding to PCP control contact 31				
PnB00	PCP Control Contact Acceleration Time 0	0 to 10000	ms	50	Immediately
	The acceleration time corresponding to PCP control contact 0				
PnB01	PCP Control Contact Acceleration Time 1	0 to 10000	ms	50	Immediately
	The acceleration time corresponding to PCP control contact 1				
PnB02	PCP Control Contact Acceleration Time 2	0 to 10000	ms	50	Immediately
	The acceleration time corresponding to PCP control contact 2				
PnB03	PCP Control Contact Acceleration Time 3	0 to 10000	ms	50	Immediately
	The acceleration time corresponding to PCP control contact 3				
PnB04	PCP Control Contact Acceleration Time 4	0 to 10000	ms	50	Immediately
	The acceleration time corresponding to PCP control contact 4				
PnB05	PCP Control Contact Acceleration Time 5	0 to 10000	ms	50	Immediately
	The acceleration time corresponding to PCP control contact 5				
PnB06	PCP Control Contact Acceleration Time 6	0 to 10000	ms	50	Immediately
	The acceleration time corresponding to PCP control contact 6				
PnB07	PCP Control Contact Acceleration Time 7	0 to 10000	ms	50	Immediately
	The acceleration time corresponding to PCP control contact 7				

No.	Index	Name	Range	Unit	Default
PnB08	PCP Control Contact Acceleration Time 8	0 to 10000	ms	50	Immediately
	The acceleration time corresponding to PCP control contact 8				
PnB09	PCP Control Contact Acceleration Time 9	0 to 10000	ms	50	Immediately
	The acceleration time corresponding to PCP control contact 9				
PnB10	PCP Control Contact Acceleration Time 10	0 to 10000	ms	50	Immediately
	The acceleration time corresponding to PCP control contact 10				
PnB11	PCP Control Contact Acceleration Time 11	0 to 10000	ms	50	Immediately
	The acceleration time corresponding to PCP control contact 11				
PnB12	PCP Control Contact Acceleration Time 12	0 to 10000	ms	50	Immediately
	The acceleration time corresponding to PCP control contact 12				
PnB13	PCP Control Contact Acceleration Time 13	0 to 10000	ms	50	Immediately
	The acceleration time corresponding to PCP control contact 13				
PnB14	PCP Control Contact Acceleration Time 14	0 to 10000	ms	50	Immediately
	The acceleration time corresponding to PCP control contact 14				
PnB15	PCP Control Contact Acceleration Time 15	0 to 10000	ms	50	Immediately
	The acceleration time corresponding to PCP control contact 15				
PnB16	PCP Control Contact Acceleration Time 16	0 to 10000	ms	50	Immediately
	The acceleration time corresponding to PCP control contact 16				
PnB17	PCP Control Contact Acceleration Time 17	0 to 10000	ms	50	Immediately
	The acceleration time corresponding to PCP control contact 17				
PnB18	PCP Control Contact Acceleration Time 18	0 to 10000	ms	50	Immediately
	The acceleration time corresponding to PCP control contact 18				

No.	Index	Name	Range	Unit	Default
PnB19	PCP Control Contact Acceleration Time 19	0 to 10000	ms	50	Immediately
	The acceleration time corresponding to PCP control contact 19				
PnB20	PCP Control Contact Acceleration Time 20	0 to 10000	ms	50	Immediately
	The acceleration time corresponding to PCP control contact 20				
PnB21	PCP Control Contact Acceleration Time 21	0 to 10000	ms	50	Immediately
	The acceleration time corresponding to PCP control contact 21				
PnB22	PCP Control Contact Acceleration Time 22	0 to 10000	ms	50	Immediately
	The acceleration time corresponding to PCP control contact 22				
PnB23	PCP Control Contact Acceleration Time 23	0 to 10000	ms	50	Immediately
	The acceleration time corresponding to PCP control contact 23				
PnB24	PCP Control Contact Acceleration Time 24	0 to 10000	ms	50	Immediately
	The acceleration time corresponding to PCP control contact 24				
PnB25	PCP Control Contact Acceleration Time 25	0 to 10000	ms	50	Immediately
	The acceleration time corresponding to PCP control contact 25				
PnB26	PCP Control Contact Acceleration Time 26	0 to 10000	ms	50	Immediately
	The acceleration time corresponding to PCP control contact 26				
PnB27	PCP Control Contact Acceleration Time 27	0 to 10000	ms	50	Immediately
	The acceleration time corresponding to PCP control contact 27				
PnB28	PCP Control Contact Acceleration Time 28	0 to 10000	ms	50	Immediately
	The acceleration time corresponding to PCP control contact 28				
PnB29	PCP Control Contact Acceleration Time 29	0 to 10000	ms	50	Immediately
	The acceleration time corresponding to PCP control contact 29				

No.	Index	Name	Range	Unit	Default
PnB30	PCP Control Contact Acceleration Time 30	0 to 10000	ms	50	Immediately
	The acceleration time corresponding to PCP control contact 30				
PnB31	PCP Control Contact Acceleration Time 31	0 to 10000	ms	50	Immediately
	The acceleration time corresponding to PCP control contact 31				
PnB32	PCP Control Contact Deceleration Time 0	0 to 10000	ms	50	Immediately
	The deceleration time corresponding to PCP control contact 0				
PnB33	PCP Control Contact Deceleration Time 1	0 to 10000	ms	50	Immediately
	The deceleration time corresponding to PCP control contact 1				
PnB34	PCP Control Contact Deceleration Time 2	0 to 10000	ms	50	Immediately
	The deceleration time corresponding to PCP control contact 2				
PnB35	PCP Control Contact Deceleration Time 3	0 to 10000	ms	50	Immediately
	The deceleration time corresponding to PCP control contact 3				
PnB36	PCP Control Contact Deceleration Time 4	0 to 10000	ms	50	Immediately
	The deceleration time corresponding to PCP control contact 4				
PnB37	PCP Control Contact Deceleration Time 5	0 to 10000	ms	50	Immediately
	The deceleration time corresponding to PCP control contact 5				
PnB38	PCP Control Contact Deceleration Time 6	0 to 10000	ms	50	Immediately
	The deceleration time corresponding to PCP control contact 6				
PnB39	PCP Control Contact Deceleration Time 7	0 to 10000	ms	50	Immediately
	The deceleration time corresponding to PCP control contact 7				
PnB40	PCP Control Contact Deceleration Time 8	0 to 10000	ms	50	Immediately
	The deceleration time corresponding to PCP control contact 8				

No.	Index	Name	Range	Unit	Default
PnB41	PCP Control Contact Deceleration Time 9	0 to 10000	ms	50	Immediately
	The deceleration time corresponding to PCP control contact 9				
PnB42	PCP Control Contact Deceleration Time 10	0 to 10000	ms	50	Immediately
	The deceleration time corresponding to PCP control contact 10				
PnB43	PCP Control Contact Deceleration Time 11	0 to 10000	ms	50	Immediately
	The deceleration time corresponding to PCP control contact 11				
PnB44	PCP Control Contact Deceleration Time 12	0 to 10000	ms	50	Immediately
	The deceleration time corresponding to PCP control contact 12				
PnB45	PCP Control Contact Deceleration Time 13	0 to 10000	ms	50	Immediately
	The deceleration time corresponding to PCP control contact 13				
PnB46	PCP Control Contact Deceleration Time 14	0 to 10000	ms	50	Immediately
	The deceleration time corresponding to PCP control contact 14				
PnB47	PCP Control Contact Deceleration Time 15	0 to 10000	ms	50	Immediately
	The deceleration time corresponding to PCP control contact 15				
PnB48	PCP Control Contact Deceleration Time 16	0 to 10000	ms	50	Immediately
	The deceleration time corresponding to PCP control contact 16				
PnB49	PCP Control Contact Deceleration Time 17	0 to 10000	ms	50	Immediately
	The deceleration time corresponding to PCP control contact 17				
PnB50	PCP Control Contact Deceleration Time 18	0 to 10000	ms	50	Immediately
	The deceleration time corresponding to PCP control contact 18				
PnB51	PCP Control Contact Deceleration Time 19	0 to 10000	ms	50	Immediately
	The deceleration time corresponding to PCP control contact 19				

No.	Index	Name	Range	Unit	Default
PnB52	PCP Control Contact Deceleration Time 20	0 to 10000	ms	50	Immediately
	The deceleration time corresponding to PCP control contact 20				
PnB53	PCP Control Contact Deceleration Time 21	0 to 10000	ms	50	Immediately
	The deceleration time corresponding to PCP control contact 21				
PnB54	PCP Control Contact Deceleration Time 22	0 to 10000	ms	50	Immediately
	The deceleration time corresponding to PCP control contact 22				
PnB55	PCP Control Contact Deceleration Time 23	0 to 10000	ms	50	Immediately
	The deceleration time corresponding to PCP control contact 23				
PnB56	PCP Control Contact Deceleration Time 24	0 to 10000	ms	50	Immediately
	The deceleration time corresponding to PCP control contact 24				
PnB57	PCP Control Contact Deceleration Time 25	0 to 10000	ms	50	Immediately
	The deceleration time corresponding to PCP control contact 25				
PnB58	PCP Control Contact Deceleration Time 26	0 to 10000	ms	50	Immediately
	The deceleration time corresponding to PCP control contact 26				
PnB59	PCP Control Contact Deceleration Time 27	0 to 10000	ms	50	Immediately
	The deceleration time corresponding to PCP control contact 27				
PnB60	PCP Control Contact Deceleration Time 28	0 to 10000	ms	50	Immediately
	The deceleration time corresponding to PCP control contact 28				
PnB61	PCP Control Contact Deceleration Time 29	0 to 10000	ms	50	Immediately
	The deceleration time corresponding to PCP control contact 29				
PnB62	PCP Control Contact Deceleration Time 30	0 to 10000	ms	50	Immediately
	The deceleration time corresponding to PCP control contact 30				

No.	Index	Name	Range	Unit	Default
PnB63	PCP Control Contact Deceleration Time 31	0 to 10000	ms	50	Immediately
	The deceleration time corresponding to PCP control contact 31				
PnB64	PCP Control Contact Delay 0	0 to 10000	ms	100	Immediately
	The delay time corresponding to PCP control contact 0				
PnB65	PCP Control Contact Delay 1	0 to 10000	ms	100	Immediately
	The delay time corresponding to PCP control contact 1				
PnB66	PCP Control Contact Delay 2	0 to 10000	ms	100	Immediately
	The delay time corresponding to PCP control contact 2				
PnB67	PCP Control Contact Delay 3	0 to 10000	ms	100	Immediately
	The delay time corresponding to PCP control contact 3				
PnB68	PCP Control Contact Delay 4	0 to 10000	ms	100	Immediately
	The delay time corresponding to PCP control contact 4				
PnB69	PCP Control Contact Delay 5	0 to 10000	ms	100	Immediately
	The delay time corresponding to PCP control contact 5				
PnB70	PCP Control Contact Delay 6	0 to 10000	ms	100	Immediately
	The delay time corresponding to PCP control contact 6				
PnB71	PCP Control Contact Delay 7	0 to 10000	ms	100	Immediately
	The delay time corresponding to PCP control contact 7				
PnB72	PCP Control Contact Delay 8	0 to 10000	ms	100	Immediately
	The delay time corresponding to PCP control contact 8				
PnB73	PCP Control Contact Delay 9	0 to 10000	ms	100	Immediately
	The delay time corresponding to PCP control contact 9				
PnB74	PCP Control Contact Delay 10	0 to 10000	ms	100	Immediately
	The delay time corresponding to PCP control contact 10				
PnB75	PCP Control Contact Delay 11	0 to 10000	ms	100	Immediately
	The delay time corresponding to PCP control contact 11				

No.	Index	Name	Range	Unit	Default
PnB76	PCP Control Contact Delay 12	0 to 10000	ms	100	Immediately
	The delay time corresponding to PCP control contact 12				
PnB77	PCP Control Contact Delay 13	0 to 10000	ms	100	Immediately
	The delay time corresponding to PCP control contact 13				
PnB78	PCP Control Contact Delay 14	0 to 10000	ms	100	Immediately
	The delay time corresponding to PCP control contact 14				
PnB79	PCP Control Contact Delay 15	0 to 10000	ms	100	Immediately
	The delay time corresponding to PCP control contact 15				
PnB80	PCP Control Contact Delay 16	0 to 10000	ms	100	Immediately
	The delay time corresponding to PCP control contact 16				
PnB81	PCP Control Contact Delay 17	0 to 10000	ms	100	Immediately
	The delay time corresponding to PCP control contact 17				
PnB82	PCP Control Contact Delay 18	0 to 10000	ms	100	Immediately
	The delay time corresponding to PCP control contact 18				
PnB83	PCP Control Contact Delay 19	0 to 10000	ms	100	Immediately
	The delay time corresponding to PCP control contact 19				
PnB84	PCP Control Contact Delay 20	0 to 10000	ms	100	Immediately
	The delay time corresponding to PCP control contact 20				
PnB85	PCP Control Contact Delay 21	0 to 10000	ms	100	Immediately
	The delay time corresponding to PCP control contact 21				
PnB86	PCP Control Contact Delay 22	0 to 10000	ms	100	Immediately
	The delay time corresponding to PCP control contact 22				
PnB87	PCP Control Contact Delay 23	0 to 10000	ms	100	Immediately
	The delay time corresponding to PCP control contact 23				
PnB88	PCP Control Contact Delay 24	0 to 10000	ms	100	Immediately
	The delay time corresponding to PCP control contact 24				

No.	Index	Name	Range	Unit	Default
PnB89	PCP Control Contact Delay 25	0 to 10000	ms	100	Immediately
	The delay time corresponding to PCP control contact 25				
PnB90	PCP Control Contact Delay 26	0 to 10000	ms	100	Immediately
	The delay time corresponding to PCP control contact 26				
PnB91	PCP Control Contact Delay 27	0 to 10000	ms	100	Immediately
	The delay time corresponding to PCP control contact 27				
PnB92	PCP Control Contact Delay 28	0 to 10000	ms	100	Immediately
	The delay time corresponding to PCP control contact 28				
PnB93	PCP Control Contact Delay 29	0 to 10000	ms	100	Immediately
	The delay time corresponding to PCP control contact 29				
PnB94	PCP Control Contact Delay 30	0 to 10000	ms	100	Immediately
	The delay time corresponding to PCP control contact 30				
PnB95	PCP Control Contact Delay 31	0 to 10000	ms	100	Immediately
	The delay time corresponding to PCP control contact 31				

Chapter 12 Object Dictionary

Index	Subindex	Object	Name	Type	Attr.	PDO	Support						Unit
							All	IP	PP	PV	PT	HM	
1000	--	VAR	device_type	UINT32	RO	NO	•						
1001	--	VAR	error_register	UINT8	RO	NO	•						
1003	--	VAR	pre_defined_error_field	UINT8	RW	NO	•						
1005	--	VAR	cob_id_sync	UINT32	RW	NO	•						
1006	--	VAR	communication_cycle_period	UINT32	RW	NO	•						
1007	--	VAR	synchronous_window_length	UINT32	RW	NO	•						
1014	--	VAR	cob_id_emergency_message	UINT32	RW	NO	•						
1016	--	ARRAY	consumer_heartbeat_time	--	--	--	•						
	0		number_of_entries	UINT8	RO	NO	•						
	1		consumer_heartbeat_time1	UINT32	RW	NO	•						
1017		VAR	producer_heartbeat_time	UINT16	RW	NO	•						
1018	--	RECORD	identity_object	--	--	--	•						
	0		number_of_entries	UINT8	RO	NO	•						
	1		vendor_id	UINT32	RO	NO	•						
	2		product_code	UINT32	RO	NO	•						
	3		revision_number	UINT32	RO	NO	•						
	4		serial_number	UINT32	RO	NO	•						

Index	Subindex	Object	Name	Type	Attr.	PDO	Support						Unit
							All	IP	PP	PV	PT	HM	
1029	--	ARRAY	error_behaviour	--	--	--	•						
	0		number_of_entries	UINT8	RO	NO	•						
	1		communication_error	UINT8	RW	NO	•						
1200	--	RECORD	server_sdo_parameter	--	--	--	•						
	0		number_of_entries	UINT8	RO	NO	•						
	1		cob_id_client_server	UINT32	RO	NO	•						
	2		cob_id_server_client	UINT32	RO	NO	•						
1400	--	RECORD	receive_pdo_parameter_rpdo1	--	--	--	•						
	0		number_of_entries_rpdo1	UINT8	RO	NO	•						
	1		cob_id_used_by_pdo_rpdo1	UINT32	RO	NO	•						
	2		transmission_type_rpdo1	UINT8	RW	NO	•						
1401	--	RECORD	receive_pdo_parameter_rpdo2	--	--	--	•						
	0		number_of_entries_rpdo2	UINT8	RO	NO	•						
	1		cob_id_used_by_pdo_rpdo2	UINT32	RO	NO	•						
	2		transmission_type_rpdo2	UINT8	RW	NO	•						
1402	--	RECORD	receive_pdo_parameter_rpdo3	--	--	--	•						
	0		number_of_entries_rpdo3	UINT8	RO	NO	•						
	1		cob_id_used_by_pdo_rpdo3	UINT32	RO	NO	•						
	2		transmission_type_rpdo3	UINT8	RW	NO	•						

Index	Subindex	Object	Name	Type	Attr.	PDO	Support						Unit
							All	IP	PP	PV	PT	HM	
1403	--	RECORD	receive_pdo_parameter_rpdo4	--	--	--	•						
	0		number_of_entries_rpdo4	UINT8	RO	NO	•						
	1		cob_id_used_by_pdo_rpdo4	UINT32	RO	NO	•						
	2		transmission_type_rpdo4	UINT8	RW	NO	•						
1600	--	RECORD	receive_pdo_mapping_rpdo1	--	--	--	•						
	0		number_of_entries	UINT8	RO	NO	•						
	1		first_mapped_object_rpdo1	UINT32	RW	NO	•						
	2		second_mapped_object_rpdo1	UINT32	RW	NO	•						
	3		third_mapped_object_rpdo1	UINT32	RW	NO	•						
	4		fourth_mapped_object_rpdo1	UINT32	RW	NO	•						
1601	--	RECORD	receive_pdo_mapping_rpdo2	--	--	--	•						
	0		number_of_entries	UINT8	RO	NO	•						
	1		first_mapped_object_rpdo2	UINT32	RW	NO	•						
	2		second_mapped_object_rpdo2	UINT32	RW	NO	•						
	3		third_mapped_object_rpdo2	UINT32	RW	NO	•						
	4		fourth_mapped_object_rpdo2	UINT32	RW	NO	•						
1602	--	RECORD	receive_pdo_mapping_rpdo3	--	--	--	•						
	0		number_of_entries	UINT8	RO	NO	•						
	1		first_mapped_object_rpdo3	UINT32	RW	NO	•						
	2		second_mapped_object_rpdo3	UINT32	RW	NO	•						
	3		third_mapped_object_rpdo3	UINT32	RW	NO	•						

Index	Subindex	Object	Name	Type	Attr.	PDO	Support						Unit
							All	IP	PP	PV	PT	HM	
	4		fourth_mapped_object_rpdo3	UINT32	RW	NO	•						
1603	--	RECORD	receive_pdo_mapping_rpdo4	--	--	--	•						
	0		number_of_entries	UINT8	RO	NO	•						
	1		first_mapped_object_rpdo4	UINT32	RW	NO	•						
	2		second_mapped_object_rpdo4	UINT32	RW	NO	•						
	3		third_mapped_object_rpdo4	UINT32	RW	NO	•						
	4		fourth_mapped_object_rpdo4	UINT32	RW	NO	•						
1800	--	RECORD	transmit_pdo_parameter_tpdo1	--	--	--	•						
	0		number_of_entries_tpdo1	UINT32	RO	NO	•						
	1		cob_id_used_by_pdo_tpdo1	UINT32	RO	NO	•						
	2		transmission_type_tpdo1	UINT8	RW	NO	•						
	3		inhibit_time_tpdo1	UINT16	RW	NO	•						
	5		event_timer_tpdo1	UINT16	RW	NO	•						
1801	--	RECORD	transmit_pdo_parameter_tpdo2	--	--	--	•						
	0		number_of_entries_tpdo2	UINT32	RO	NO	•						
	1		cob_id_used_by_pdo_tpdo2	UINT32	RO	NO	•						
	2		transmission_type_tpdo2	UINT8	RW	NO	•						
	3		inhibit_time_tpdo2	UINT16	RW	NO	•						
	5		event_timer_tpdo2	UINT16	RW	NO	•						
1802	--	RECORD	transmit_pdo_parameter_tpdo3	--	--	--	•						
	0		number_of_entries_tpdo3	UINT32	RO	NO	•						

Index	Subindex	Object	Name	Type	Attr.	PDO	Support						Unit
							All	IP	PP	PV	PT	HM	
	1		cob_id_used_by_pdo_tpdo3	UINT32	RO	NO	•						
	2		transmission_type_tpdo3	UINT8	RW	NO	•						
	3		inhibit_time_tpdo3	UINT16	RW	NO	•						
	5		event_timer_tpdo3	UINT16	RW	NO	•						
1803	--	RECORD	transmit_pdo_parameter_tpdo4	--	--	--	•						
	0		number_of_entries_tpdo4	UINT32	RO	NO	•						
	1		cob_id_used_by_pdo_tpdo4	UINT32	RO	NO	•						
	2		transmission_type_tpdo4	UINT8	RW	NO	•						
	3		inhibit_time_tpdo4	UINT16	RW	NO	•						
	5		event_timer_tpdo4	UINT16	RW	NO	•						
1A00	--	RECORD	transmit_pdo_mapping_tpdo1	--	--	--	•						
	0		number_of_entries	UINT8	RO	NO	•						
	1		first_mapped_object_tpdo1	UINT32	RW	NO	•						
	2		second_mapped_object_tpdo1	UINT32	RW	NO	•						
	3		third_mapped_object_tpdo1	UINT32	RW	NO	•						
	4		fourth_mapped_object_tpdo1	UINT32	RW	NO	•						
1A01	--	RECORD	transmit_pdo_mapping_tpdo2	--	--	--	•						
	0		number_of_entries	UINT8	RO	NO	•						
	1		first_mapped_object_tpdo2	UINT32	RW	NO	•						
	2		second_mapped_object_tpdo2	UINT32	RW	NO	•						
	3		third_mapped_object_tpdo2	UINT32	RW	NO	•						

Index	Subindex	Object	Name	Type	Attr.	PDO	Support						Unit
							All	IP	PP	PV	PT	HM	
	4		fourth_mapped_object_tpdo2	UINT32	RW	NO	•						
1A02	--	RECORD	transmit_pdo_mapping_tpdo3	--	--	--	•						
	0		number_of_entries	UINT8	RO	NO	•						
	1		first_mapped_object_tpdo3	UINT32	RW	NO	•						
	2		second_mapped_object_tpdo3	UINT32	RW	NO	•						
	3		third_mapped_object_tpdo3	UINT32	RW	NO	•						
	4		fourth_mapped_object_tpdo3	UINT32	RW	NO	•						
1A03	--	RECORD	transmit_pdo_mapping_tpdo4	--	--	--	•						
	0		number_of_entries	UINT8	RO	NO	•						
	1		first_mapped_object_tpdo4	UINT32	RW	NO	•						
	2		second_mapped_object_tpdo4	UINT32	RW	NO	•						
	3		third_mapped_object_tpdo4	UINT32	RW	NO	•						
	4		fourth_mapped_object_tpdo4	UINT32	RW	NO	•						
2000	--	RECORD	mask_tpdo1	--	--	--	•						
	0		number_of_entries	UINT8	RO	NO	•						
	1		mask1_tpdo1	UINT32	RW	NO	•						
	2		mask2_tpdo1	UINT32	RW	NO	•						
2001	--	RECORD	mask_tpdo2	--	--	--	•						
	0		number_of_entries	UINT8	RO	NO	•						
	1		mask1_tpdo2	UINT32	RW	NO	•						
	2		mask2_tpdo2	UINT32	RW	NO	•						

Index	Subindex	Object	Name	Type	Attr.	PDO	Support						Unit
							All	IP	PP	PV	PT	HM	
2002	--	RECORD	mask_tpdo3	--	--	--	•						
	0		number_of_entries	UINT8	RO	NO	•						
	1		mask1_tpdo3	UINT32	RW	NO	•						
	2		mask2_tpdo3	UINT32	RW	NO	•						
2003	--	RECORD	mask_tpdo4	--	--	--	•						
	0		number_of_entries	UINT8	RO	NO	•						
	1		mask1_tpdo4	UINT32	RW	NO	•						
	2		mask2_tpdo4	UINT32	RW	NO	•						
2105	0	VAR	sync_time_period	UINT32	RW	NO	•						
30A5	--	VAR	SinglePos	UINT32	RO	YES	•						pulse
30A6	--	VAR	MultiPos	UINT32	RO	YES	•						--
30A7	--	VAR	HomingStatus	UINT16	RW	NO	•						--
30A8	--	VAR	ExtEncPosition	INT32	RO	YES	•						pulse
30A9	--	VAR	MultiPosAfterProc	UINT32	RO	YES	•						--
30AA	--	VAR	ActualPosAfterProc	UINT32	RO	YES	•						pulse
3164	--	VAR	Pn000 Basic Function Selections 0	INT32	RW	NO	•						--
3165	--	VAR	Pn001 Basic Function Selections 1	INT32	RW	NO	•						--
3166	--	VAR	Pn002 Application Function Selections 2	INT32	RW	NO	•						--
3167	--	VAR	Pn003 Application Function Selections 3	INT32	RW	NO	•						--

Index	Subindex	Object	Name	Type	Attr.	PDO	Support						Unit
							All	IP	PP	PV	PT	HM	
3168	--	VAR	Pn004 Application Function Selections 4	INT32	RW	NO	•						--
3169	--	VAR	Pn005 Application Function Selections 5	INT32	RW	NO	•						--
316A	--	VAR	Pn006 Application Function Selections 6	INT32	RW	NO	•						--
316B	--	VAR	Pn007 Application Function Selections 7	INT32	RW	NO	•						--
316C	--	VAR	Pn008 Power On Options	INT32	RW	NO	•						--
316D	--	VAR	Pn009 Application Function Selections 9	INT32	RW	NO	•						--
31C8	--	VAR	Pn100 Tuning Function Selection	INT32	RW	NO	•						--
31C9	--	VAR	Pn101 Response Frequency Level	INT32	RW	NO	•						Hz
31CA	--	VAR	Pn102 Speed Loop Gain	INT32	RW	NO	•						rad/s
31CB	--	VAR	Pn103 Speed Loop Integral Time	INT32	RW	NO	•						0.1ms
31CC	--	VAR	Pn104 Position Loop Gain	INT32	RW	NO	•						1/s
31CD	--	VAR	Pn105 Torque Reference Filter Time Constant	INT32	RW	NO	•						0.01ms
31CE	--	VAR	Pn106 Load Inertia Percentage	INT32	RW	NO	•						%
31CF	--	VAR	Pn107 Second Speed Loop Gain	INT32	RW	NO	•						rad/s
31D0	--	VAR	Pn108 Second Speed Loop Integral Time	INT32	RW	NO	•						0.1ms

Index	Subindex	Object	Name	Type	Attr.	PDO	Support						Unit
							All	IP	PP	PV	PT	HM	
31D1	--	VAR	Pn109 Second Position Loop Gain	INT32	RW	NO	•						1/s
31D2	--	VAR	Pn110 Second Torque Reference Filter Time Constant	INT32	RW	NO	•						0.01ms
31D4	--	VAR	Pn112 Speed Feedforward	INT32	RW	NO	•						%
31D5	--	VAR	Pn113 Speed Feedforward Filter Time Constant	INT32	RW	NO	•						0.1ms
31D6	--	VAR	Pn114 Torque Feedforward	INT32	RW	NO	•						%
31D7	--	VAR	Pn115 Torque Feedforward Filter Time Constant	INT32	RW	NO	•						0.1ms
31D8	--	VAR	Pn116 P/PI Switching Conditions	INT32	RW	NO	•						--
31D9	--	VAR	Pn117 P/PI Switching Level for Torque Reference	INT32	RW	NO	•						%
31DA	--	VAR	Pn118 P/PI Switching Level for Position Deviation	INT32	RW	NO	•						pulse
31DB	--	VAR	Pn119 P/PI Switching Level for Acceleration	INT32	RW	NO	•						10rpm/s
31DC	--	VAR	Pn120 P/PI Switching Level for Speed Reference	INT32	RW	NO	•						rpm
31DD	--	VAR	Pn121 Gain Switching Conditions	INT32	RW	NO	•						--
31DE	--	VAR	Pn122 Gain Switching Waiting Time	INT32	RW	NO	•						0.1ms
31DF	--	VAR	Pn123 Gain Switching Level	INT32	RW	NO	•						--
31E0	--	VAR	Pn124 Speed Level	INT32	RW	NO	•						rpm

Index	Subindex	Object	Name	Type	Attr.	PDO	Support						Unit
							All	IP	PP	PV	PT	HM	
31E1	--	VAR	Pn125 Position Gain Switching Time	INT32	RW	NO	•						0.1ms
31E2	--	VAR	Pn126 Gain Switching Hysteresis	INT32	RW	NO	•						--
31E3	--	VAR	Pn127 Speed Measurement Filter at Low Speed	INT32	RW	NO	•						1 cycle
31E6	--	VAR	Pn130 Friction Compensation Gain	INT32	RW	NO	•						0.1%Tn
31E7	--	VAR	Pn131 Friction Compensation Speed Hysteresis	INT32	RW	NO	•						rpm
31E8	--	VAR	Pn132 Friction Damping Proportion	INT32	RW	NO	•						0.1%Tn/1000rpm
31EB	--	VAR	Pn135 Speed Feedback Filter Time	INT32	RW	NO	•						0.01ms
31FA	--	VAR	Pn150 Control-Related Selections	INT32	RW	NO	•						--
31FB	--	VAR	Pn151 Model Following Control Gain	INT32	RW	NO	•						1/s
31FC	--	VAR	Pn152 Model Following Control Gain Correction	INT32	RW	NO	•						%
31FD	--	VAR	Pn153 Model Following Control Speed Feedforward Coefficient	INT32	RW	NO	•						%
31FE	--	VAR	Pn154 Model Following Control Torque Feedforward Coefficient	INT32	RW	NO	•						%
31FF	--	VAR	Pn155 Anti-Resonance Frequency for Jitter Suppression	INT32	RW	NO	•						0.1Hz
3200	--	VAR	Pn156 Filter Time Constant for Jitter Suppression	INT32	RW	NO	•						0.1ms

Index	Subindex	Object	Name	Type	Attr.	PDO	Support						Unit	
							All	IP	PP	PV	PT	HM		
3201	--	VAR	Pn157 Low frequency jitter suppression speed feedforward compensation amount limiting	INT32	RW	NO	•							rpm
3204	--	VAR	Pn160 Load Disturbance Compensation	INT32	RW	NO	•							%
3205	--	VAR	Pn161 Load Disturbance Detection Gain	INT32	RW	NO	•							Hz
3206	--	VAR	Pn162 Use Estimated Speed	INT32	RW	NO	•							--
3208	--	VAR	Pn164 PJO0 Rotation Number	INT32	RW	NO	•							rev
3209	--	VAR	Pn165 PJO0 Rotation Speed	INT32	RW	NO	•							rpm
320A	--	VAR	Pn166 PJO0 Acceleration/Deceleration Time	INT32	RW	NO	•							ms
320B	--	VAR	Pn167 PJO0 Stop Time	INT32	RW	NO								ms
320C	--	VAR	Pn168 PJO1 Rotation Number	INT32	RW	NO	•							rev
320D	--	VAR	Pn169 PJO1 Rotation Speed	INT32	RW	NO	•							rpm
320E	--	VAR	Pn170 PJO1 Acceleration/Deceleration Time	INT32	RW	NO	•							ms
320F	--	VAR	Pn171 PJO1 Stop Time	INT32	RW	NO	•							ms
3210	--	VAR	Pn172 Moment of Inertia Calculation Amount	INT32	RW	NO	•							--
3211	--	VAR	Pn173 Vibration Suppression Frequency at Intermediate-Frequency	INT32	RW	NO	•							Hz
3212	--	VAR	Pn174 Vibration Suppression Bandwidth Adjustment at Intermediate-Frequency	INT32	RW	NO	•							--

Index	Subindex	Object	Name	Type	Attr.	PDO	Support						Unit	
							All	IP	PP	PV	PT	HM		
3213	--	VAR	Pn175 Vibration Suppression Damping Gain at Intermediate-Frequency	INT32	RW	NO	•							--
3214	--	VAR	Pn176 Vibration Suppression Lowpass Filter Time at Intermediate-Frequency	INT32	RW	NO	•							0.1ms
3215	--	VAR	Pn177 Vibration Suppression Highpass Filter Time at Intermediate-Frequency	INT32	RW	NO	•							0.1ms
3216	--	VAR	Pn178 Vibration Suppression Proportional Attenuation Gain at Intermediate-Frequency	INT32	RW	NO	•							--
3217	--	VAR	Pn179 Vibration Amplitude Detection Level	INT32	RW	NO	•							--
3218	--	VAR	Pn180 Vibration Frequency Detection Level	INT32	RW	NO	•							Hz
3219	--	VAR	Pn181 Notch Filter Frequency 1	INT32	RW	NO	•							Hz
321A	--	VAR	Pn182 Notch Filter Depth 1	INT32	RW	NO	•							--
321B	--	VAR	Pn183 Notch Filter Width 1	INT32	RW	NO	•							--
321C	--	VAR	Pn184 Notch Filter Frequency 2	INT32	RW	NO	•							Hz
321D	--	VAR	Pn185 Notch Filter Depth 2	INT32	RW	NO	•							--
321E	--	VAR	Pn186 Notch Filter Width 2	INT32	RW	NO	•							--
321F	--	VAR	Pn187 Notch Filter Frequency 3	INT32	RW	NO	•							Hz
3220	--	VAR	Pn188 Notch Filter Depth 3	INT32	RW	NO	•							--
3221	--	VAR	Pn189 Notch Filter Width 3	INT32	RW	NO	•							--

Index	Subindex	Object	Name	Type	Attr.	PDO	Support						Unit
							All	IP	PP	PV	PT	HM	
3222	--	VAR	Pn190 Automatic Vibration Suppression State	INT32	RW	NO	•						--
3223	--	VAR	Pn191 Vibration Frequency Detection Level	INT32	RW	NO	•						--
322C	--	VAR	Pn200 Pulse Numbers for PG Frequency Division	INT32	RW	NO	•						pulse
3233	--	VAR	Pn207 Homing locked-rotor torque	INT32	RW	NO	•						%Tn
3234	--	VAR	Pn208 Homing locked-rotor time	INT32	RW	NO	•						1 cycle
3236	--	VAR	Pn210 2nd Encoder Functions 1	INT32	RW	NO	•						--
3237	--	VAR	Pn211 2nd Encoder Functions 2	INT32	RW	NO	•						--
3238	--	VAR	Pn212 2nd Encoder Resolution	INT32	RW	NO	•						pulse
3239	--	VAR	Pn213 Position Deviation Overflow Warning Level at Fully Closed-loop Control	INT32	RW	NO	•						pulse
323A	--	VAR	Pn214 Position Deviation Reset Level at Fully Closed-loop Control	INT32	RW	NO	•						%
3245	--	VAR	Pn225 Encoder delay compensation mode	INT32	RW	NO	•						--
3246	--	VAR	Pn226 Encoder delay manual compensation value	INT32	RW	NO	•						10ns
3248	--	VAR	Pn228 User Defined Multi-Resolution	INT32	RW	NO	•						--
3294	--	VAR	Pn304 Parameter Reference Speed	INT32	RW	NO	•						rpm

Index	Subindex	Object	Name	Type	Attr.	PDO	Support						Unit
							All	IP	PP	PV	PT	HM	
3295	--	VAR	Pn305 JOG Speed	INT32	RW	NO	•						rpm
3296	--	VAR	Pn306 Soft Start Acceleration Time	INT32	RW	NO	•						ms
3297	--	VAR	Pn307 Soft Start Deceleration Time	INT32	RW	NO	•						ms
3298	--	VAR	Pn308 Speed Feedback Filter Time Constant	INT32	RW	NO	•						ms
3299	--	VAR	Pn309 S-Curve Rise Time	INT32	RW	NO	•						ms
329A	--	VAR	Pn310 Speed Reference Curve Form	INT32	RW	NO	•						--
329B	--	VAR	Pn311 S-Curve Selection	INT32	RW	NO	•						--
32A7	--	VAR	Pn323 Overspeed Detection Level	INT32	RW	NO	•						rpm
32AF	--	VAR	Pn331 Touch Probe Signal Allocation	INT32	RW	NO	•						--
32B0	--	VAR	Pn332 Touch Probe Filtering Time	INT32	RW	NO	•						10ns
32B1	--	VAR	Pn333 Touch Probe Singal Inverts	INT32	RW	NO	•						--
32F5	--	VAR	Pn401 Forward Internal Torque Limit	INT32	RW	NO	•						%
32F6	--	VAR	Pn402 Reverse Internal Torque Limit	INT32	RW	NO	•						%
32F7	--	VAR	Pn403 Forward External Torque Limit	INT32	RW	NO	•						%

Index	Subindex	Object	Name	Type	Attr.	PDO	Support						Unit
							All	IP	PP	PV	PT	HM	
32F8	--	VAR	Pn404 Reverse External Torque Limit	INT32	RW	NO	•						%
32F9	--	VAR	Pn405 Reverse Brake Torque Limit	INT32	RW	NO	•						%
32FA	--	VAR	Pn406 Torque Limit at Undervoltage	INT32	RW	NO	•						%
32FB	--	VAR	Pn407 Release Time for Torque Limit at Undervoltage	INT32	RW	NO	•						ms
32FC	--	VAR	Pn408 Speed Limit during Torque Control	INT32	RW	NO	•						rpm
3358	--	VAR	Pn500 Positioning Completed Width	INT32	RW	NO	•						pulse
3359	--	VAR	Pn501 Speed Coincidence Signal Detection Width	INT32	RW	NO	•						rpm
335B	--	VAR	Pn503 Rotation Detection Speed	INT32	RW	NO	•						rpm
335C	--	VAR	Pn504 Deviation Counter Overflow Alarm	INT32	RW	NO	•						1 pulse
335D	--	VAR	Pn505 Servo ON Waiting Time	INT32	RW	NO	•						ms
335E	--	VAR	Pn506 Brake Reference-Servo OFF Delay Time	INT32	RW	NO	•						10ms
335F	--	VAR	Pn507 Brake Reference Waiting Speed	INT32	RW	NO	•						rpm
3360	--	VAR	Pn508 Brake Reference Waiting Time	INT32	RW	NO	•						10ms
3361	--	VAR	Pn509 Input Signal Allocations 1	INT32	RW	NO	•						--
3362	--	VAR	Pn510 Input Signal Allocations 2	INT32	RW	NO	•						--

Index	Subindex	Object	Name	Type	Attr.	PDO	Support						Unit
							All	IP	PP	PV	PT	HM	
3363	--	VAR	Pn511 Output Signal Allocations	INT32	RW	NO	•						--
3364	--	VAR	Pn512 Input Contact Data (Low Bits) at Bus Control	INT32	RW	NO	•						--
3365	--	VAR	Pn513 Input Contact Data (High Bit) at Bus Control	INT32	RW	NO	•						--
3366	--	VAR	Pn514 Input Signals Filter Time	INT32	RW	NO	•						1 cycle
3367	--	VAR	Pn515 Alarm Signals Filter Time	INT32	RW	NO	•						2 cycle
3368	--	VAR	Pn516 Input Singal Inverts 1	INT32	RW	NO	•						--
3369	--	VAR	Pn517 Input Singal Inverts 2	INT32	RW	NO	•						--
336A	--	VAR	Pn518 Dynamic Brake Time	INT32	RW	NO	•						0.5ms
336B	--	VAR	Pn519 Serial Encoder Error Allowed Time	INT32	RW	NO	•						1 cycle
336C	--	VAR	Pn520 Positioning Completion Time	INT32	RW	NO	•						0.1ms
336D	--	VAR	Pn521 Alarm Masks 1	INT32	RW	NO	•						--
3371	--	VAR	Pn525 Overload Alarm Level	INT32	RW	NO	•						%
3374	--	VAR	Pn528 Ouput Signal Inverts	INT32	RW	NO	•						--
3375	--	VAR	Pn529 Torque Detection Signal Output Level	INT32	RW	NO	•						%
3376	--	VAR	Pn530 Torque Detection Signal Ouput Time	INT32	RW	NO	•						ms
3379	--	VAR	Pn533 Dynamic Brake Current Detection Level	INT32	RW	NO	•						mA

Index	Subindex	Object	Name	Type	Attr.	PDO	Support						Unit
							All	IP	PP	PV	PT	HM	
337A	--	VAR	Pn534 IPM Junction Temperature Detection Level	INT32	RW	NO	•						°C
337B	--	VAR	Pn535 Discharging Resistor Resistance	INT32	RW	NO	•						Ω
337C	--	VAR	Pn536 Discharging Resistor Power	INT32	RW	NO	•						W
337E	--	VAR	Pn538 Momentary Power Interruption Hold Time	INT32	RW	NO	•						1 cycle
337F	--	VAR	Pn539 Pumping Turn ON Delay Time	INT32	RW	NO	•						ms
3380	--	VAR	Pn540 Pumping Turn OFF Delay Time	INT32	RW	NO	•						ms
3381	--	VAR	Pn541 Motion Err Iqr Threshold	INT32	RW	NO	•						% In
3382	--	VAR	Pn542 Motion Err Acc Threshold	INT32	RW	NO	•						krpm/s
3423	--	VAR	Pn703 CAN baut	INT32	RW	NO	•						--
3424	--	VAR	Pn704 Device Node Number	INT32	RW	NO	•						--
3434	--	VAR	Pn720 Homing Mode	INT32	RW	NO	•						--
3435	--	VAR	Pn721 Research Reference Point Speed	INT32	RW	NO	•						0.1rpm
3436	--	VAR	Pn722 Origin Research Speed	INT32	RW	NO	•						0.1rpm
3437	--	VAR	Pn723 Origin Research Acceleration	INT32	RW	NO	•						0.1r/m/s
3438	--	VAR	Pn724 Origin Return Offset Pulse	INT32	RW	NO	•						pulse

Index	Subindex	Object	Name	Type	Attr.	PDO	Support						Unit
							All	IP	PP	PV	PT	HM	
3439	--	VAR	Pn725 Electronic Gear Ratio (Numerator)	INT32	RW	NO	•						--
343A	--	VAR	Pn726 Electronic Gear Ratio (Denominator)	INT32	RW	NO	•						--
3484	--	VAR	Pn800 Motor Applied Settings 1	INT32	RW	NO	•						--
3485	--	VAR	Pn801 Motor Applied Settings 2	INT32	RW	NO	•						--
3486	--	VAR	Pn802 Encoder Initial Value	INT32	RW	NO	•						--
3488	--	VAR	Pn804 Motor Serials Selection	INT32	RW	NO	•						--
3489	--	VAR	Pn805 Motor Module Selection	INT32	RW	NO	•						--
348A	--	VAR	Pn806 Motor Voltage Class	INT32	RW	NO	•						--
348B	--	VAR	Pn807 Motor Power	INT32	RW	NO	•						W
348C	--	VAR	Pn808 Motor Temperature Sensor Model	INT32	RW	NO	•						--
348D	--	VAR	Pn809 Motor Derating Factor	INT32	RW	NO	•						0.01Tn
348E	--	VAR	Pn810 Motor Rated Torque	INT32	RW	NO	•						0.01Nm
348F	--	VAR	Pn811 Motor Maximum Torque	INT32	RW	NO	•						0.01Nm
3490	--	VAR	Pn812 Motor Reated Current	INT32	RW	NO	•						0.1A
3491	--	VAR	Pn813 Motor Maximum Curren	INT32	RW	NO	•						0.1A
3492	--	VAR	Pn814 Motor Reated Speed	INT32	RW	NO	•						rpm
3493	--	VAR	Pn815 Motor Maximum Speed	INT32	RW	NO	•						rpm
3494	--	VAR	Pn816 Motor Ultimate Speed	INT32	RW	NO	•						rpm
3495	--	VAR	Pn817 a0*10000	INT32	RW	NO	•						--

Index	Subindex	Object	Name	Type	Attr.	PDO	Support						Unit
							All	IP	PP	PV	PT	HM	
3496	--	VAR	Pn818 a1*10000	INT32	RW	NO	•						--
3497	--	VAR	Pn819 a2*10000	INT32	RW	NO	•						--
3498	--	VAR	Pn820 a3*10000	INT32	RW	NO	•						--
3499	--	VAR	Pn821 a4*10000	INT32	RW	NO	•						--
349A	--	VAR	Pn822 b0*10000	INT32	RW	NO	•						--
349B	--	VAR	Pn823 b1*10000	INT32	RW	NO	•						--
349C	--	VAR	Pn824 b2*10000	INT32	RW	NO	•						--
349D	--	VAR	Pn825 b3*10000	INT32	RW	NO	•						--
349E	--	VAR	Pn826 b4*10000	INT32	RW	NO	•						--
349F	--	VAR	Pn827 Opposing EMF Factor (Ke)	INT32	RW	NO	•						0.01V/Krpm
34A0	--	VAR	Pn828 Phase Resistance (Rs)	INT32	RW	NO	•						0.001Ω
34A1	--	VAR	Pn829 Ld	INT32	RW	NO	•						0.1mH
34A2	--	VAR	Pn830 Lq	INT32	RW	NO	•						0.1mH
34A3	--	VAR	Pn831 Moment of Inertia for Motor	INT32	RW	NO	•						1e-8Kgm^2
34A4	--	VAR	Pn832 Pole Number	INT32	RW	NO	•						--
34A5	--	VAR	Pn833 Electrical Time Constant (te)	INT32	RW	NO	•						0.01ms
34A6	--	VAR	Pn834 Mechanical Time Constant (tm)	INT32	RW	NO	•						0.01ms
34A7	--	VAR	Pn835 Thermal Time Constant (th)	INT32	RW	NO	•						0.01ms

Index	Subindex	Object	Name	Type	Attr.	PDO	Support						Unit
							All	IP	PP	PV	PT	HM	
34A8	--	VAR	Pn836 Thermal Model Parameters Tp[0]*10000	INT32	RW	NO	•						--
34A9	--	VAR	Pn837 Thermal Model Parameters Tp[1]*10000	INT32	RW	NO	•						--
34AA	--	VAR	Pn838 Thermal Model Parameters Tp[2]*10000	INT32	RW	NO	•						--
34AB	--	VAR	Pn839 Thermal Model Parameters Tp[3]*10000	INT32	RW	NO	•						--
34AC	--	VAR	Pn840 Thermal Model Parameters Tp[4]*10000	INT32	RW	NO	•						--
34AD	--	VAR	Pn841 Motor Overload Curve Coefficient k[0]*10000	INT32	RW	NO	•						--
34AE	--	VAR	Pn842 Motor Overload Curve Coefficient k[1]*10000	INT32	RW	NO	•						--
34AF	--	VAR	Pn843 Motor Overload Curve Coefficient k[2]*10000	INT32	RW	NO	•						--
34B0	--	VAR	Pn844 Motor Overload Curve Coefficient k[3]*10000	INT32	RW	NO	•						--
34B1	--	VAR	Pn845 Motor Overload Curve Coefficient k[4]*10000	INT32	RW	NO	•						--
34CF	--	VAR	Pn875 Application Function Select	INT32	RW	NO	•						--
34D1	--	VAR	Pn877 Encoder Protocol Selection	INT32	RW	NO	•						--
34D2	--	VAR	Pn878 Encoder Type Selection	INT32	RW	NO	•						--
34D3	--	VAR	Pn879 Encoder Actual Resolution	INT32	RW	NO	•						--

Index	Subindex	Object	Name	Type	Attr.	PDO	Support						Unit
							All	IP	PP	PV	PT	HM	
34D4	--	VAR	Pn880 Encoder Resolution for Program Using	INT32	RW	NO	•						--
34D5	--	VAR	Pn881 Encoder Resolution for Multi-turn Data	INT32	RW	NO	•						--
34D9	--	VAR	Pn885 Servodrive Applied Setting	INT32	RW	NO	•						--
34E3	--	VAR	Pn895 Alarm Masks 7	INT32	RW	NO	•						--
34F6	--	VAR	Pn914 Asynchronous Drive Amplitude (Uq)	INT32	RW	NO	•						‰
34F7	--	VAR	Pn915 Asynchronous Drive Frequency	INT32	RW	NO	•						--
34F8	--	VAR	Pn916 Current Loop Bandwidth	INT32	RW	NO	•						Hz
34F9	--	VAR	Pn917 Dead Zone Compensation Percentage	INT32	RW	NO	•						%
34FC	--	VAR	Pn920 Function Selection for Test	INT32	RW	NO	•						--
34FD	--	VAR	Pn921 Test Mode Settings	INT32	RW	NO	•						--
34FE	--	VAR	Pn922 Current loop step test Id given percentage	INT32	RW	NO	•						%
34FF	--	VAR	Pn923 Iq Given Percentage for Current Loop Step Test	INT32	RW	NO	•						%
3501	--	VAR	Pn925 Current loop frequency response test Iq given offset percentage	INT32	RW	NO	•						%
3502	--	VAR	Pn926 Current loop frequency response test Iq given amplitude percentage	INT32	RW	NO	•						%

Index	Subindex	Object	Name	Type	Attr.	PDO	Support						Unit
							All	IP	PP	PV	PT	HM	
3504	--	VAR	Pn928 Speed loop frequency response test speed given offset	INT32	RW	NO	•						rpm
3505	--	VAR	Pn929 Speed loop frequency response test speed given amplitude	INT32	RW	NO	•						rpm
3507	--	VAR	Pn931 DA output voltage amplitude in frequency response test mode	INT32	RW	NO	•						0.1V
3508	--	VAR	Pn932 Sweep frequency	INT32	RW	NO	•						Hz
350B	--	VAR	Pn935 One Volt Corresponding Pulse Number	INT32	RW	NO	•						--
350C	--	VAR	Pn936 Output Voltage Scale Factor in Position Loop Frequency Response Test	INT32	RW	NO	•						--
350D	--	VAR	Pn937 Output Voltage Offset in Position Loop Frequency Response Test	INT32	RW	NO	•						--
350F	--	VAR	Pn939 STO Function Selection	INT32	RW	NO	•						--
3510	--	VAR	Pn940 Interrupt Cycle Time	INT32	RW	NO	•						--
3511	--	VAR	Pn941 EM3A Motor Flux-weakening Selection	INT32	RW	NO	•						--
3512	--	VAR	Pn942 Flux-weakening PI Regulator (kp)	INT32	RW	NO	•						0.01
3513	--	VAR	Pn943 Flux-weakening PI Regulator (ki)	INT32	RW	NO	•						0.1
3514	--	VAR	Pn944 Mechanical Analyzer Order	INT32	RW	NO	•						--

Index	Subindex	Object	Name	Type	Attr.	PDO	Support						Unit
							All	IP	PP	PV	PT	HM	
351A	--	VAR	Pn950 Overmodulation Selection	INT32	RW	NO	•						--
351B	--	VAR	Pn951 Tz Selection	INT32	RW	NO	•						--
351C	--	VAR	Pn952 Amplifying Tmax, Pn401/Pn402	INT32	RW	NO	•						0.01
351D	--	VAR	Pn953 Motor Amplified (Imax)	INT32	RW	NO	•						0.01
351E	--	VAR	Pn954 Alarm Self-test Selection	INT32	RW	NO	•						--
351F	--	VAR	Pn955 Bus Voltage Correction	INT32	RW	NO	•						V
3521	--	VAR	Pn957 ePWM forced synchronization enable bit in EC mode Validate After Restart	INT32	RW	NO	•						--
3524	--	VAR	Pn960 Alarm Masks 1	INT32	RW	NO	•						--
3525	--	VAR	Pn961 Alarm Masks 2	INT32	RW	NO	•						--
3526	--	VAR	Pn962 Alarm Masks 3	INT32	RW	NO	•						--
3527	--	VAR	Pn963 Alarm Masks 4	INT32	RW	NO	•						--
3528	--	VAR	Pn964 Alarm Masks 5	INT32	RW	NO	•						--
3529	--	VAR	Pn965 Alarm Masks 6	INT32	RW	NO	•						--
3685	--	ARRAY	EncAlmClrVar	--	--	--	•						--
	0		number_of_entries	UINT8	RO	NO	•						--
	1		ClrAllEncAlm	UINT16	RW	NO	•						--
	2		ClrMultiEncAlm	UINT16	RW	NO	•						--
603F	--	VAR	Error_code	UINT16	RO	YES	•						--
6040	--	VAR	controlword	UINT16	RW	YES	•						--

Index	Subindex	Object	Name	Type	Attr.	PDO	Support						Unit
							All	IP	PP	PV	PT	HM	
6041	--	VAR	statusword	UINT16	RO	YES	•						--
605A	--	VAR	quick_stop_option_code	INT16	RW	NO	•						--
605B	--	VAR	shutdown_option_code	INT16	RW	NO	•						--
605C	--	VAR	disable_operation_option_code	INT16	RW	NO	•						--
605D	--	VAR	stop_option_code	INT16	RW	NO	•						--
605E	--	VAR	fault_reaction_option_code	INT16	RW	NO	•						--
6060	--	VAR	modes_of_operation	UINT8	RW	YES	•						--
6061	--	VAR	modes_of_operation_display	UINT8	RO	YES	•						--
6062	--	VAR	position_demand_value	INT32	RO	YES			•				position units
6063	--	VAR	position_actual_value*	INT32	RO	YES			•				inc
6064	--	VAR	position_actual_value	INT32	RO	YES		•	•		•	•	position units
6065	--	VAR	following_error_window	UINT32	RW	YES			•				position units
6066	--	VAR	following_error_time_out	UINT16	RW	YES			•				ms
6067	--	VAR	position_window	UINT32	RW	YES			•				position units
6068	--	VAR	position_window_time	UINT16	RW	YES			•				ms
6069	--	VAR	velocity_sensor_actual_value	INT32	RO	YES				•			speed units
606B	--	VAR	velocity_demand_value	INT32	RO	YES				•			speed units
606C	--	VAR	velocity_actual_value	INT32	RO	YES	•						speed units
606D	--	VAR	velocity_window	UINT16	RW	YES				•			speed units
606E	--	VAR	velocity_window_time	UINT16	RW	YES				•			ms
606F	--	VAR	velocity_threshold	UINT16	RW	YES				•			speed units

Index	Subindex	Object	Name	Type	Attr.	PDO	Support						Unit
							All	IP	PP	PV	PT	HM	
6070	--	VAR	velocity_threshold_time	UINT16	RW	YES				•			ms
6071	--	VAR	target_torque	INT16	RW	YES					•		0.1% Tn
6072	--	VAR	Max_torque	UINT16	RW	YES					•		0.1% Tn
6074	--	VAR	torque_demand_value	INT16	RO	YES					•		0.1% Tn
6077	--	VAR	torque_actual_value	INT32	RO	YES		•	•		•		0.1% Tn
6078	--	VAR	Current actual value	INT16	RO	YES		•	•		•		0.1%In
607A	--	VAR	target_position	INT32	RW	YES			•				position units
607C	--	VAR	home_offset	INT32	RW	YES	•						position units
607D	--	ARRAY	Software_position_limit	--	--	--			•				--
	0		number_of_entries	UINT8	RW	NO			•				--
	1		min_soft_position_limit	INT32	RW	NO			•				position units
	2		max_soft_position_limit	INT32	RW	NO			•				position units
607E	--	VAR	polarity	UINT8	RW	YES	•						position units
607F	--	VAR	Max_profile_velocity	UINT32	RW	YES			•	•			speed units
6080	--	VAR	Max motor speed	UINT32	RW	YES			•				rpm
6081	--	VAR	profile_velocity	UINT32	RW	YES			•				speed units
6082	--	VAR	end_velocity	UINT32	RW	YES			•				speed units
6083	--	VAR	profile_acceleration	UINT32	RW	YES			•	•			acceleration units
6084	--	VAR	profile_deceleration	UINT32	RW	YES			•	•			acceleration units

Index	Subindex	Object	Name	Type	Attr.	PDO	Support						Unit
							All	IP	PP	PV	PT	HM	
6085	--	VAR	quick_stop_deceleration	UINT32	RW	YES			•	•			acceleration units
6086	--	VAR	motion_profile_type	INT16	RW	YES			•				--
6087	--	VAR	torque_slope	UINT32	RW	YES					•		0.1%Tn/S
6093	--	ARRAY	position_factor	--	--	--	•		•		•	•	--
	0		number_of_entries	UINT32	RW	NO	•		•		•	•	--
	1		numerator	UINT32	RW	NO	•		•		•	•	--
	2		divisor	UINT32	RW	NO	•		•		•	•	--
6094	--	ARRAY	velocity_encoder_factor	--	--	--	•						--
	0		number_of_entries	UINT32	RW	NO	•						--
	1		numerator	UINT32	RW	NO	•						--
	2		divisor	UINT32	RW	NO	•						--
6097	--	ARRAY	acceleration_factor	--	--	--	•						--
	0		number_of_entries	UINT8	RW	NO	•						--
	1		numerator	UINT32	RW	NO	•						--
	2		divisor	UINT32	RW	NO	•						--
6098	--	VAR	homing_method	INT8	RW	YES					•		--
6099	--	ARRAY	homing_speeds	--	--	--						•	--
	0		number_of_entries	UINT8	RO	NO						•	--
	1		speed_during_search_for_switch	UINT32	RW	YES						•	speed units
	2		speed_during_search_for_zero	UINT32	RW	YES						•	speed units

Index	Subindex	Object	Name	Type	Attr.	PDO	Support						Unit
							All	IP	PP	PV	PT	HM	
609A	--	VAR	homing_acceleration	UINT32	RW	YES						•	0.1rpm/s
60A4	--	ARRAY	profile_jerk					•	•				--
	0		number_of_entries	UINT8	RO	NO		•	•				--
	1		profile_jerk1	UINT32	RW	YES		•	•				pulse/s/s/125us
60B1	--	VAR	VelocityOffset	INT32	RW	YES	•						speed units
60B2	--	VAR	TorqueOffset	INT16	RW	YES	•						0.1%Tn
60B8	--	VAR	Touch Probe Function	UINT16	RW	YES	•						--
60B9	--	VAR	Touch Probe Status	UINT16	RO	YES	•						--
60BA	--	VAR	Touch Probe Pos1 Pos Value	INT32	RO	YES	•						pulse
60BB	--	VAR	Touch Probe Pos1 Neg Value	INT32	RO	YES	•						pulse
60BC	--	VAR	Touch Probe Pos2 Pos Value	INT32	RO	YES	•						pulse
60BD	--	VAR	Touch Probe Pos2 Neg Value	INT32	RO	YES	•						pulse
60C0	--	VAR	Interpolation sub mode select	INT16	RW	NO	•						--
60C1	--	ARRAY	Interpolation data record										--
	0		number_of_entries	UINT8	RO	NO		•					--
	1		Interpolation data record1	INT32	RW	YES		•					pulse
	2		Interpolation data record2	INT32	RW	NO		•					pulse
60C2	--	ARRAY	Interpolation_Time										--
	0		number_of_entries	UINT8	RO	NO		•					--
	1		Interpolation_Time_Unit	UINT8	RW	NO		•					--
	2		Interpolation_Time_Index	INT8	RW	NO		•					--

Index	Subindex	Object	Name	Type	Attr.	PDO	Support						Unit
							All	IP	PP	PV	PT	HM	
60C5	--	VAR	Max_acceleration	UINT32	RW	YES	•						0.1rpm/s
60C6	--	VAR	Max_deceleration	UINT32	RW	YES	•						0.1rpm/s
60E0	--	VAR	PosTorLimit	UINT16	RW	YES	•						%0.1Tn
60E1	--	VAR	NegTorLimit	UINT16	RW	YES	•						%0.1Tn
60F4	--	VAR	Following_error_actual_value	INT32	RO	YES		•					pulse
60FA	--	VAR	control_effort	INT32	RO	YES		•				•	--
60FC	--	VAR	position_demand_value*	INT32	RO	YES		•				•	pulse
60FD	--	VAR	digital_intputs	UINT32	RO	YES	•						--
60FE	--	ARRAY	digital_outputs										--
	0		number_of_entries	UINT8	RO	NO	•						--
	1		physical_outputs	UINT32	RW	YES	•						--
	2		bit_mask	UINT32	RW	NO	•						--
60FF	--	VAR	target_velocity	INT32	RW	YES				•			speed units
6502	--	VAR	Supported drive modes	UINT32	RO	NO	•						--

Revision History

Date	Version	Revised Contents
Sep 2022	V0.01	Initial release (DRAFT)

Trio Motion Technology Limited

 www.triomotion.uk