



STÖBER

**POSIDRIVE® FDS 5000**



**NEXT GENERATION!**



### Functional housing design

As part of the STOBER EMC strategy, all the housings in the POSIDRIVE® FDS 5000 series are made of galvanized sheet steel. They shield against electromagnetic interference and thus increase the units' RFI immunity and reduce interference emission.

The housing incorporates the operator keypad, display, LED indicators, Paramodul and RS232 interface.

The optional field bus modules (PROFIBUS, PROFINET, EtherCAT®, CANopen®) are easily plugged in from the top.

## THE PURPOSE DESIGNED ASYNCHRONOUS SERVO AXIS

### New innovation potential for feed and positioning drives

The versatile and reliable POSIDRIVE® FDS has been further developed to form the 5000 series.

The innovative development approach concentrated on perfect use of the **POSITool software** and the smooth and fast **field bus communication** with different bus systems.

The performance profile of the POSIDRIVE® FDS 5000 is configurable for specific applications.

The practical spectrum of functionalities enables the POSIDRIVE® FDS 5000 to take over complex control tasks

from the higher-level plant or machine control system.

Typical **applications** for POSIDRIVE® FDS 5000 inverters are packaging systems, automation engineering and machine tool manufacture with challenging feed systems and positioning drives.

### Paramodul

Plug-in memory module for transfer of all program and settings data.



If a POSIDRIVE® FDS 5000 has to be replaced, the existing Paramodul is simply plugged into the new unit to restart operations. The functionality is retained without restriction.





# TOWARDS NEW GOALS WITH A NEW SOFTWARE GENERATION

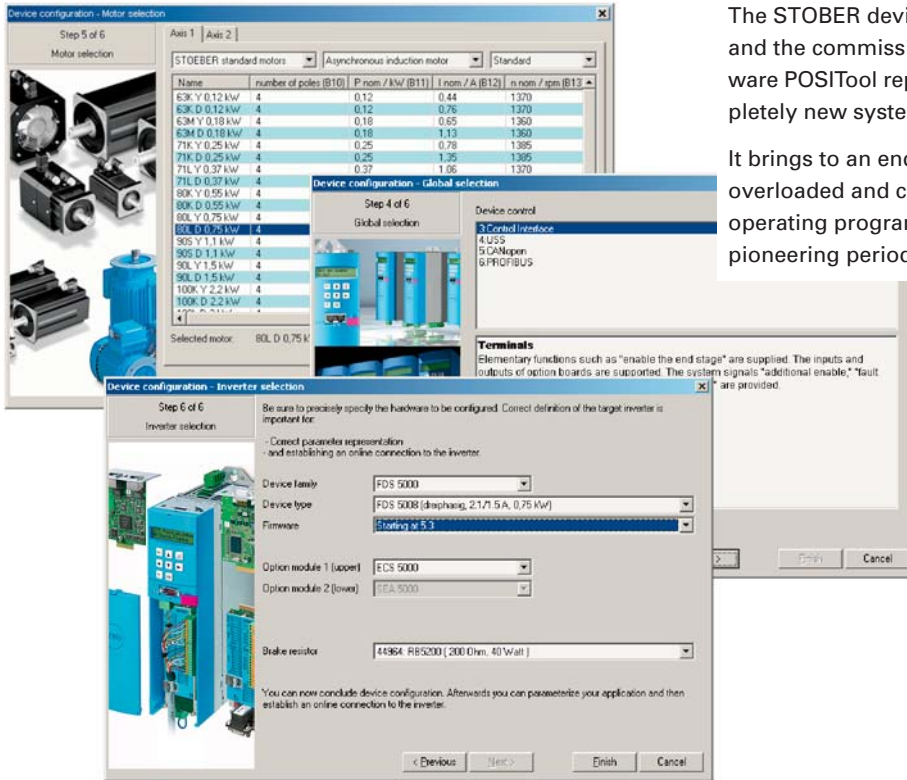

The STOBBER device firmware and the commissioning software POSITool represent a completely new system technology.

It brings to an end the era of overloaded and confusing operating programs from the pioneering period of inverters.

POSITool is based on a completely new, modular 3-layer architecture with ergonomic interface design. An applications library with parameterization assistant and an additional flexible graphics programming facility forms a successful bridge between custom-made design and universality.

## POSIDRIVE® FDS 5000. OPTIMIZED FOR MGS GEARED MOTORS FROM 0.37 TO 7.5 kW

The MGS modular geared motor system is based on four gear unit series with high running precision and a variety of equipment options. The power and speed are logically grouped. These factors qualify the MGS system for design of a very specific actuator system.

For operation in VC mode (high dynamics vector control with speed feedback), MGS system motors are fitted with incremental encoders.

POSIDRIVE® FDS 5000 is hardware and software optimized for use with MGS geared motors. They are suitable for operation with all industry standard motors of other manufacturers.

The POSIDRIVE® FDS 5000 offers a choice of 3 different control modes

**VC mode – High-dynamic vector control with speed feedback**

Inputs for incremental encoder (standard) and digital evaluation. The MGS geared motor becomes a cost-effective 'asynchronous servo axis'.

**SLVC – Motor control through sensorless vector control**

Good dynamic performance and accuracy through vector control without encoder and speed feedback.

**V/f – Motor control through frequency selection**

For multimotor operation.

MGS system motor with incremental encoder

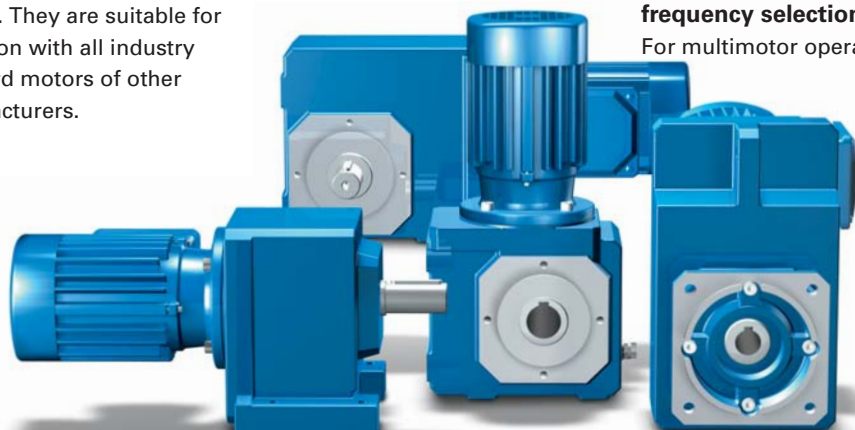

Encoder interfaces for 2 systems:  
HTL incremental encoder ("24V" for MGS system motors)  
TTL incremental encoder (RS422, "5V")

# MODULAR SOFTWARE ARCHITECTURE

The high dynamism of electronic development brings about continuous improvements and extending of functions, particularly with frequency inverters. But associated with this is continuously increasing user software complexity. A trend which is in stark contrast to the need for simple and accurate usability.

This conflict of objectives has been addressed by STÖBER ANTRIEBSTECHNIK and Software Suite V5 developed as a solution. This suite includes the commissioning software POSITool, a comprehensive library with standard applications, as well as the firmware for the inverter generation 5000.

Instead of rigidly defined firmware with endless parameter settings, the operator finds a modern, ergonomically designed user interface.

## For everyday

To configure a drive, the commissioning software POSITool offers a library with typical pre-produced basic applications. Here is a selection:

- Fast reference value
- Comfort reference value
- Speed or torque reference value (selectable)
- 3 analog reference values
- 16 fixed reference values
- Motorized potentiometer
- PID controller reference value
- Reference values scalable as absolute or percentage value
- Command positioning
- Powerful single axis positioning control with command interface in accordance with PLCopen® and the additional function POSILatch. Position measurements can then be taken on external signals (e.g. linear measurements)
- Motion block positioning
- Electronic cam function

The consistent application orientation of the modules is proving extremely effective.

In particular for fast commissioning the comfort reference value ensures flexibly adjustable unit settings.

All parameterization work is supported by assistant functions.

## User-friendly system maintenance

The **documentation feature** of the commissioning software POSITool facilitates thorough system maintenance. The fine-tuned settings and operational data of each drive are recorded and documented. The Paramodul is perfect for this task.

The **data** of each individual drive are thus available for system maintenance or further configurations.

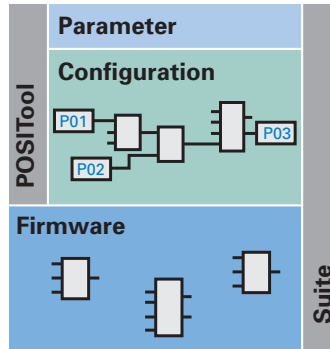

Scalable software architecture

## Other highlights

The software scalability allows optimum adaptation of functionality and response time to the application. The cycle time for reference value processing depends only on the calculation of the activated system modules and the parameters.

Even complex applications can be mapped on the same hardware platform without modifying the firmware.



With the **diagnostic function**, the cause of a fault can be found quickly with a notebook. The analysis of the 'error data' by POSITool helps service engineers to locate the actual cause quickly. If a drive fails due to overload or damage, the cause can be an undetected problem area elsewhere.

## For experts

The new, user programmable firmware has been upgraded to include a graphics editor layer. A trained user will find a variety of defined function blocks in various libraries. With these basic applications can be modified or given extra functions.

## Extra service

For customer-specific creation of a completely new functional structure or comprehensive adaptation of the graphics configuration layer, STÖBER ANTRIEBSTECHNIK offers the service package **TAILOR MADE APPLICATIONS**.

## Technical data

### POSIDRIVE® FDS 5000

Size
Type
ID (device version/H)
Recommended motor power
Supply voltage
Line fuses
Rated current $I_{rated}$
$I_{max}$
Switching frequency
Braking resistor (accessory)
Permissible motor cable length, shielded
Power loss at $I_{outp} = I_{rated}$
Power loss at $I_{outp} = 0A^2$
Conductor cross-section
Dimensions (H x W x D) [mm]
Weight [kg] without packaging
Weight [kg] with packaging
Output frequency

# UNCOMPROMISING INDUSTRIAL ELECTRONICS

## Powerful processor core

32-bit RISC processor  
Current controller 250  $\mu$ s

## Control modes

Asynchronous servo motors  
(V/f, SLVC, VC)

## Encoder interface

Incremental encoder (TTL, HTL)

## Serial interface

RS232 with USS protocol

## Slot

Communication

## Options

PROFIBUS  
PROFINET  
EtherCAT®  
CANopen®

## I/O Terminal module

### LEA5000

(8 binary inputs, 8 binary outputs)

## Operational reliability

Generously sized power stage  
for 180 % accelerating current

## Thermistor motor protection

Monitoring circuit for up to  
3 PTC thermistors

## Brake chopper integral

Thermal model monitoring of  
external resistor for overload

## Fan

Temperature controlled

## DC link connection

For energy exchange between  
several inverters

## Operator unit

8 keys, changing of parameters,  
jogging (manual operation)  
(clear text display and LED indicators)

## Paramodul

Plug-in module for power failure  
safe storage of all application  
specific data  
Data transfer without any  
further aids

## Control electronics supply

DC link power supply unit or  
power supply unit with connection  
facility for external +24 V  
(the control section remains  
functional even if the supply  
voltage is switched off)

## Ease of installation

All terminals are plug-in type  
(spring-loaded terminals)  
Supply and motor connections  
in separate places  
Twin DC link terminals, facilitates  
parallel connection  
EMC plate for shield connection

## ASP 5001

Option for the implementation  
of safety functions:

- STO and SS1 as per EN 61800-5-2
- Stop category 0 and stop category 1 as per EN 60204

Integration is possible for  
applications up to (max.):

- PL e in category 3 as per EN ISO 13948-1:2008-12 and
- SIL 3 as per EN 61800-5-2:2008-04

## POSITool Windows Software

Application selection  
(with assistant)  
Parameterization  
(with assistant)

Manages several inverters  
(FDS 5000, MDS 5000 and  
SDS 5000) in one installation

Drive optimization with POSI-  
Scope, oscilloscope function  
for internal signals (movement  
visualization), operational data  
monitoring and diagnosis



PROFIBUS DP-V1 (DP5000)

BG 0				BG 1			
FDS 5007 A	FDS 5004 A	FDS 5008 A	FDS 5015 A	FDS 5022 A	FDS 5040 A	FDS 5055 A	FDS 5075 A
55421	55420	55422	55423	55424	55425	55426	55427
0.75 kW	0.37 kW	0.75 kW	1.5 kW	2.2 kW	4.0 kW	5.5 kW	7.5 kW
(L1-N) 1 x 230 V +20 %/-40 %, 50/60 Hz	(L1-L3) 3 x 400 V +32%/-50% 50 Hz (L1-L3) 3 x 480 V +10%/-58% 60 Hz			(L1-L3) 3 x 400 V +32%/-50% 50 Hz (L1-L3) 3 x 480 V +10%/-58% 60 Hz			
1 x 10 AT	3 x 6 AT	3 x 6 AT	3 x 10 AT	3 x 10 AT	3 x 16 AT	3 x 20 AT	3 x 20 AT
3 x 4.0 A	3 x 1.3 A	3 x 2.3 A	3 x 4.5 A	3 x 5.5 A	3 x 10 A	3 x 12 A	3 x 16 A
180% / 5 sec., 150% / 30 sec.				180% / 5 sec., 150% / 30 sec.			
4 kHz (adjustable up to 16 kHz with derating)				4 kHz (adjustable up to 16 kHz with derating)			
100 $\Omega$ : max. 1.6 kW	100 $\Omega$ : max. 3.2 kW			100 $\Omega$ : max. 6.4 kW	47 $\Omega$ max. 6.4 kW	47 $\Omega$ : max. 13.6 kW	
100 m, from 50 m with output choke				100 m, from 50 m with output choke			
80 W	50 W	65 W	90 W	110 W	170 W	180 W	200 W
max. 30 W ①				max. 30 W ①			
max. 2.5 mm <sup>2</sup>				max. 4 mm <sup>2</sup>			
300 x 70 x 157 (175) ②				300 x 70 x 242 (260) ②			
2.1				3.7			
2.9				4.8			
0 – 400 Hz				0 – 400 Hz			

① depends on connected option boards and sensors (e.g. encoder) ② Depth incl. braking resistor RB5000

# COMPLETE DRIVE – THE SYSTEM SOLUTION

Drive system solutions based on modular software and hardware are the core area of expertise of the system manufacturer STÖBER ANTRIEBSTECHNIK.

The graphic opposite shows a diagram of the process of target-oriented design of a complete drive unit consisting of:

**POSIDRIVE® FDS 5000**  
frequency inverter and software

**MGS** gear unit

**MGS** system motor

The **specification for the components** follows the individual mix of requirements for the process or driven machine.

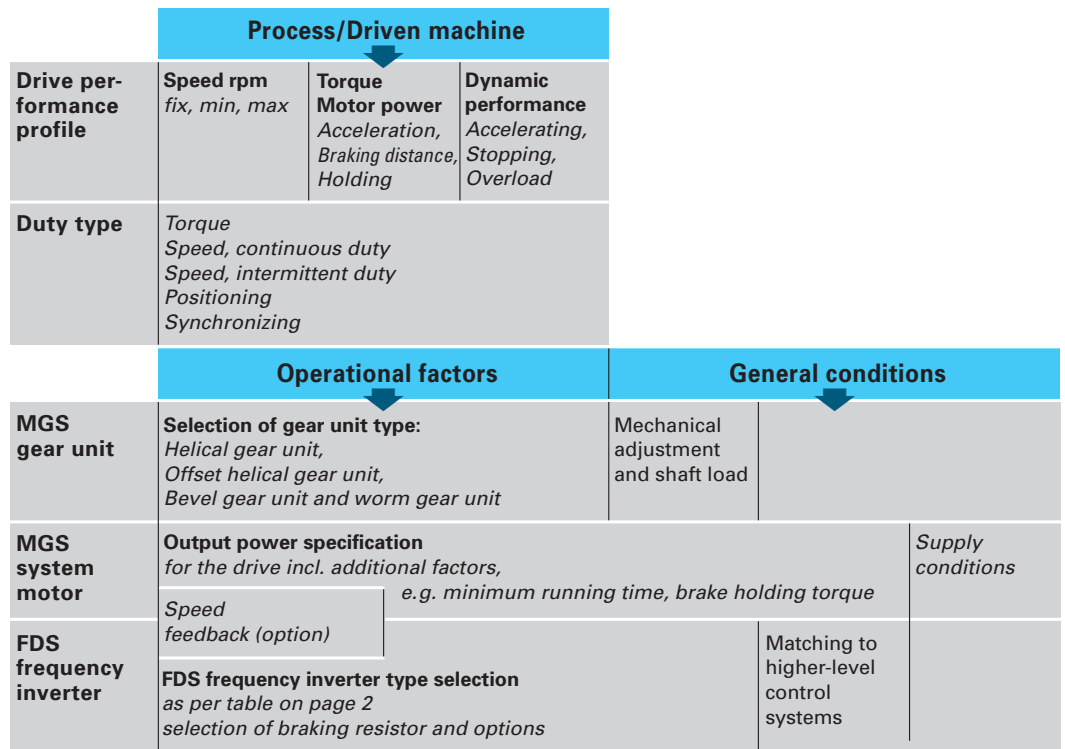

## Choosing the optimum inverter

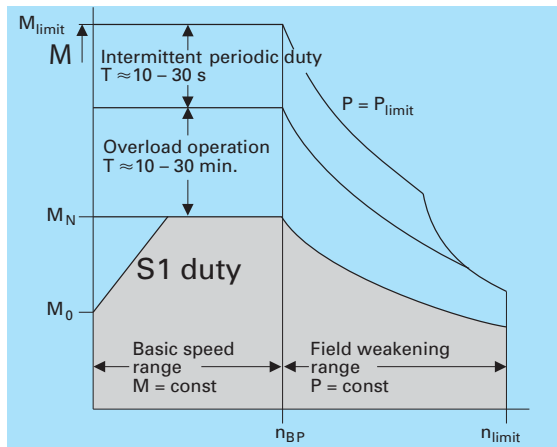

Using the breakpoint and with allowance for the power reserves, the right motor can be logically selected.

The diagrams and tables on these pages do not reflect any influencing factors of the selected MGS gear unit. You can find detailed information on these in the MGS catalogue.

## Three motor control options

	<b>VC</b> Vector control	<b>SLVC</b> Sensorless vector control	<b>V/f</b> control
Drive type	individual drive	individual drive	multi axis drive
Current rating compared to V/f control	50 %	65 %	100 %
Speed range	1:200 – 1:1000	1:15 – 1:20	1:5 – 1:10
Influence of load variations on speed	none	little	high
Torque limitation	excellent	good	none
Vibration stability	excellent	good	low
Response to critical operating conditions	excellent	good	N/A
Concentricity at low speeds	excellent	good	low
Available torque at zero speed	yes	N/A	N/A
Response to load changes	dynamic	delayed	much delayed
Response to setpoint step changes	dynamic	delayed	much delayed
Incremental encoder	yes	no	no

Speed response of the different motor control types VC, SLVS, V/f

Left:  
Response to a sudden change in the load torque

Right:  
Response to a continuous change in the load torque

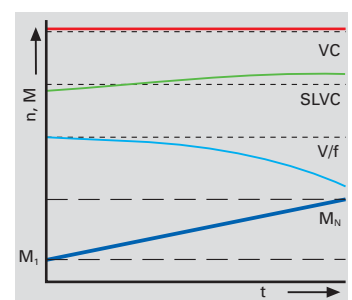
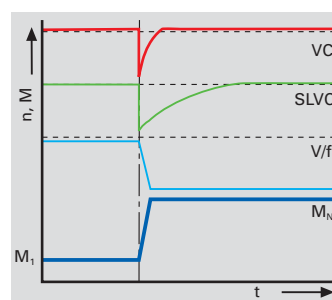

$M_1$  = starting torque ·  $M_N$  = motor rated torque ·  $t$  = time ·  $n$  = speed



# ACCURATE COMMISSIONING

The Windows commissioning software POSITool contains the following functions:

- Application configuration
- Drive parameterization
- Drive programming
- Drive commissioning
- Application commissioning
- Function optimization

The prepared functions and parameters are transferred via the RS232 interface on the device front.

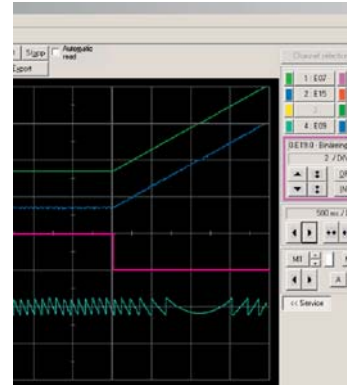

## Commissioning the MGS geared motors

The system is commissioned with the help of a notebook and the commissioning software POSITool. No software knowledge is required for this. All the adjustments are done interactively.

The POSIDRIVE® FDS 5000 inverter comes supplied with the 'fast reference value' application.

## Commissioning the complete application

This can be done either via the connected PC or after data transfer via the device **operator panel**.

The **Paramodul** is also suitable for data transfer.

Further parameterization corrections and additions can be made directly. Some knowledge (basic training) is necessary for this task.

## Digital drive tuning

The POSIScope software tool reduces trial runs for individual drive optimization to a minimum.

Previous trial and error is replaced by a full diagnosis. In **real time** the procedure is observed, recorded, analyzed and then displayed by **oscillograph** on the PC monitor.

The fine tuning thus obtained results in perfectly adjusted drives. On applications with high specifications, POSIScope can be used for **system maintenance**.

## Advanced seminars for general users and experts

The POSITool software assistant supports configuration and parameterisation of the STOEBER standard applications. Basic and advanced information on the safe handling of POSITool necessary on the job can be acquired at an application seminar.



In practical, individually designed seminars, general users learn the ways in which they can utilize the potential of the POSITool standard applications fully and effectively.

After attending the 'Free Graphic Programming' seminar, experts can expand the POSITool standard applications themselves to adapt them to specific needs.

Further information and dates can be found on our website [www.stoeber.de](http://www.stoeber.de) (Services).

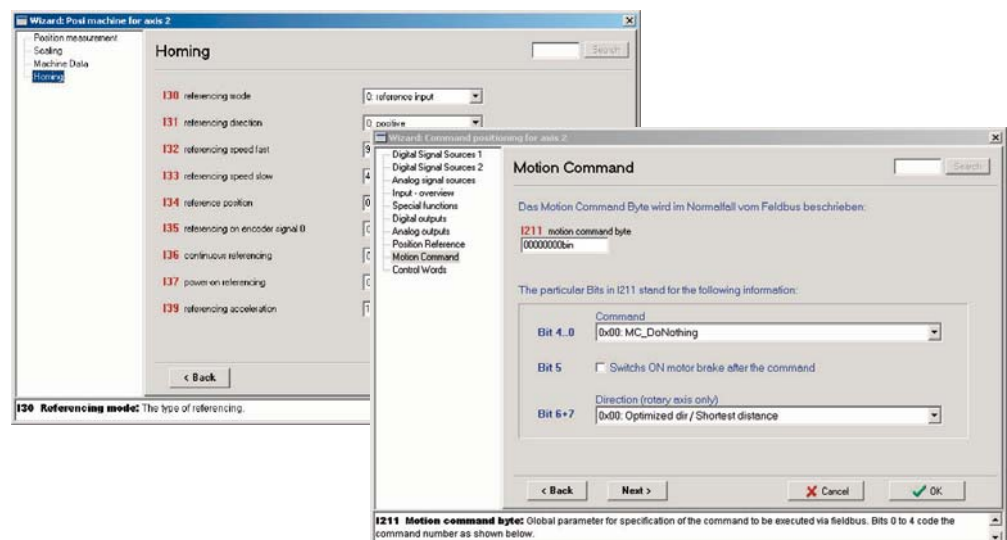

## QUICK TO ASSEMBLE

### Perfect, practical connection layout

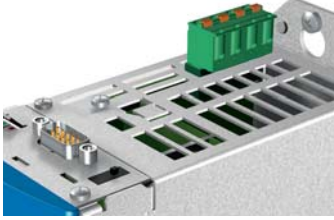

The mains or 24 V supply connection is made 'from above' through a plug-in terminal strip. In the foreground, the optional bus board connection.

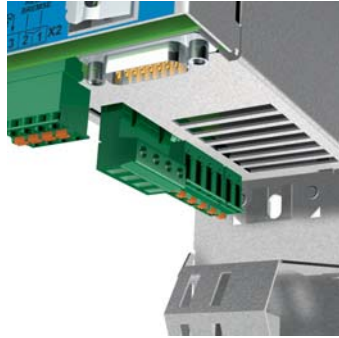

The separate connections for motor, DC link and braking resistor are located on the bottom of the housing. The PTC thermistor and braking relay are also attached here by simple plug-in mounting.

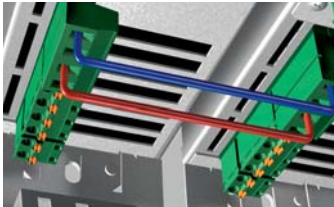

Simple DC link connection. Twin DC link terminals for easy parallel connection.

### Service

The STÖBER service system comprises 38 expert partners in Germany and more than 80 companies in the STÖBER SERVICE NETWORK worldwide.

This service concept guarantees local expertise and availability when needed.

In general, the service specialists can be reached at any time via a 24/7 service hotline.

When necessary, a problem can be addressed immediately.

**24/7 service hotline**  
**+49 180 5 786323**

## VERY EASY TO USE



Easy data transfer and acceptance with Paramodul.



Display and keypad are integrated allowing for rapid diagnosis, status monitoring, direct parameter access and jogging (manual operation).

### STÖBER AUSTRIA

www.stoerber.at  
+43 7613 7600-0  
sales@stoerber.at

### STÖBER CHINA

www.stoerber.cn  
+86 10 6590 7391  
sales@stoerber.cn

### STÖBER FRANCE

www.stoerber.fr  
+33 4 78.98.91.80  
sales@stoerber.fr

### STÖBER GERMANY

www.stoerber.de  
+49 7231 582-0  
sales@stoerber.de

### STÖBER ITALY

www.stoerber.it  
+39 02 93909570  
sales@stoerber.it

### STÖBER JAPAN

www.stoerber.co.jp  
+81 3 5395 6788  
sales@stoerber.co.jp

### STÖBER SOUTH EAST ASIA

www.stoerber.sg  
+65 65112912  
sales@stoerber.sg

### STÖBER SWITZERLAND

www.stoerber.ch  
+41 56 496 96 50  
sales@stoerber.ch

### STÖBER USA

www.stoerber.com  
+1 606 759 5090  
sales@stoerber.com