

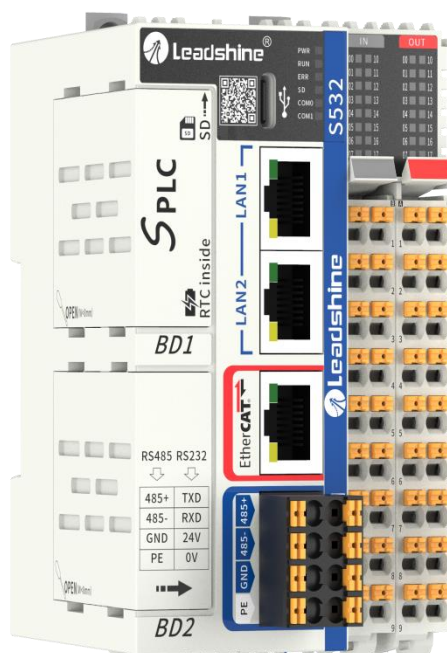

S5 Series PLC User Manual



Strong Small Slim Simple

For models of S508\ S516\ S532

©2020 Leadshine Technology Co., Ltd.

Address: 15-20/F, Block B, Nanshan I Valley, No.3185, Shahe West Road, Nanshan District,
Shenzhen, Guangdong, 518055, China

Tel: (86)755-26409254

Fax: (86)755-26402718

Web: www.leadshine.com

Sales: sales@leadshine.com

Support: tech@leadshine.com

Notice

Read this manual carefully before any assembling and using. Incorrect handling of products in this manual can result in injury and damage to persons and machinery. Strictly adhere to the technical information regarding installation requirements.

This manual is not for use or disclosure outside of Leadshine except under permission. All rights are reserved. No part of this manual shall be reproduced, stored in retrieval form, or transmitted by any means, electronic, mechanical, photocopying, recording, or otherwise without approval from Leadshine. While every precaution has been taken in the preparation of the book, Leadshine assumes no responsibility for errors or omissions.

Neither is any liability assumed for damages resulting from the use of the information contained herein.

This document is proprietary information of Leadshine that is furnished for customer use ONLY. Information in this document is subject to change without notice and does not represent a commitment on the part of Leadshine. Therefore, information contained in this manual may be updated from time-to-time due to product improvements, etc., and may not conform in every respect to former issues.

- ◆ **Thank you for purchasing Leadshine S5 series products**
- ◆ **Please read this manual carefully before operating**
- ◆ **Please keep this manual appropriately**

**Record of Revisions**

Manual Reversion	Data	Description of Release
V1.0	06/1/2025	Initial Release

Safety Precautions

Overall Notes



- Do not remove the housing with the PLC powered on. Cables, connectors and optional equipment.
- Commissioning the machine should be done with safety in mind! The user must design effective safety protection devices in the machine and include error handling programs in the software. Otherwise, it may cause personal safety accidents, property damage, etc.



- Please use the power supply specifications (number of phases.) that match the product. Voltage. Frequency.(DC).
- Be sure to connect the ground terminal of the PLC to the ground pole.
- Please do not disassemble the product yourself. Repair or modification.
- Make sure that all cable connectors are securely attached to this product. Improper installation may result in fire, or malfunction.



- The heat sink of the PLC may be hot when the power is on or when the power is just cut off. Take safety measures such as installing a cover to prevent accidental touching by hands and parts.
- Use double-insulated or reinforced insulation for control power.
- Do not use in places where water can be splashed. Corrosive environments. Do not use the product in the vicinity of flammable gases and combustible materials.
- Do not use damaged.
- Please set up an emergency stop circuit externally to ensure that the power can be cut off and the operation can be stopped immediately in case of an abnormality.
- Please to ensure that the input power is supplied within the specified voltage variation range.
- Please use a noise filter to reduce the influence of electromagnetic interference.

Precautions for Storage and Transportation



- Please follow the Commands on the packaging for storage and do not overload the product.
- Please place this product in the following environment:
 - No direct sunlight in the place.
 - Ambient temperature does not exceed the product specification.
 - Humidity does not exceed product specifications. Without condensation.
 - No corrosive gases. Place of flammable gas.
 - Dust. The place where there is less salt and metal powder.
 - No water. Oil. The place where the splash of medicine, etc. occurs.
 - Vibration or shock does not exceed product specifications.
 - No equipment generating strong magnetic fields in the vicinity.

Precautions for Installation



- Please install the PLC in a cabinet that provides fire protection. Electrical protection in the control cabinet.
- Please install this product in the following environment:
 - No direct sunlight in the place.
 - Ambient temperature does not exceed the product specification.
 - Humidity does not exceed product specifications. Without condensation.
 - No corrosive gases. Place of flammable gas.
 - Dust. Dust. The place where there is less salt and metal powder.
 - No water. Oil. The place where the splash of medicine, etc. occurs.
 - Vibration or shock does not exceed product specifications.
 - No equipment generating strong magnetic fields in the vicinity.
- Do not block the air inlet and exhaust ports, and do not allow foreign objects to enter the PLC.
- Do not step on the product or place heavy objects on the PLC.
- Make sure to keep the specified intervals between the inner surfaces of the PLC control cabinet and other machines.

Precautions for Wiring



- Installation, wiring, etc. must be done after disconnecting all power sources; avoid wiring, plugging and unplugging cables in an electrified state, as this may cause electric shocks or damage to circuits.
- Avoid dropping metal shavings or wires into the controller when screwing and wiring, as this could result in malfunction, damage to electronic components, or fire.
- After wiring is completed, check carefully to make sure that the operating voltage and the position of the terminals are correct, otherwise it may cause a fire or an accident.
- Individual grounding or single point grounding is preferred for grounding, not common grounding. Please use a grounding wire of AWG14 (2mm²) or higher, with a grounding resistance of 100Ω or less. The grounding point should be as close as possible to the PLC, and the distance between the grounding wires should be as short as possible.
- Please connect the power terminal and motor terminal firmly.
- Signal cable. The encoder cable should be a twisted shielded cable with the shield grounded at both ends.

Precautions during operation



- In locations where the operator has direct access to mechanical parts, such as loading and unloading of mechanical tools, or where machinery operates automatically, careful consideration must be given to the functioning of a field manual device or other back-up means, which needs to be independent of the programmable controller, and which can initiate or interrupt the automatic operation of the system.
- If it is necessary to modify the program while the system is running, locks or other safeguards must be considered to ensure that only authorized personnel can make the necessary modifications.
- When an alarm occurs, please reset it after investigating the cause and making sure it is safe.

Contents

S5 Series PLC User Manual	1
Notice	2
Record of Revisions	2
Safety Precautions	3
Overall Notes.....	3
Precautions for Storage and Transportation.....	3
Precautions for Installation	4
Precautions for Wiring.....	4
Precautions during operation	4
Contents	5
1. Introduction	7
1.1 Product Introduction	7
1.2 Programming Instructions	7
1.3 Arrival inspection	7
2. Product information	8
2.1 Related Products	8
2.2 Nameplate information	8
2.3 Part number	8
2.4 Parts description	9
2.5 Product Specifications	10
2.5.1 Standard	10
2.5.2 Input Port Specifications	11
2.5.3 Output Port Specifications	11
3. Installation	12
3.1 Storage and Installation Conditions	12
3.1.1 Storage condition	12
3.1.2 Operating ambience conditions	12
3.2 Mechanical Specification	12
4. Production Specifications	13
4.1 Electrical Specifications	13
4.1.1 Caveat	13
4.1.2 Power requirements	13
4.2 Input Internal Circuit And Wiring	13
4.2.1 Input Signal Wiring	13
4.2.2 Output Signal Wiring	14
5. Communications	15
5.1 Cable Selection and Fabrication	15
5.1.1 Cable selection and production standards	15
5.1.2 Steps for making tubular cables	15
5.2 EtherNet	15
5.3 EtherCAT	16
5.3.1 EtherCAT bus specification description	16
5.3.2 Wiring	16
5.3.3 Pin Definitions	16
5.3.4 Technology	16
5.4 RS485 & RS232 Serial Ports	17
6. Run and maintenance	19
6.1 Run and shutdown operations	19
6.2 Restoring the Factory Default IP Address	19
6.3 RTC Battery Maintenance	19
6.4 Replacement of batteries	19
6.5 Burning User Programs on USB Flash Drives	20

6.6 Burning user programs through the network port.....	20
Contact us.....	21



1. Introduction

1.1 Product Introduction

The Leadshine S5 series of thin-film motion control PLCs are designed for high-precision automation equipment! It supports 6-axis pulse control and 8/16/32-axis EtherCAT bus control, which not only meets the demand of pulse control of traditional stepper/servo, but also realizes high-speed synchronous motion control through EtherCAT, and can be expanded to 32-axis linkage at most!

The S5 series adopts 6 programming languages (LD, FBD, ST, IL, SFC, CFC) in accordance with the IEC61131-3 international standard, and engineers can switch freely according to their habits.

Supporting FB/FC function blocks, the S5 series can encapsulate complex processes into reusable modules, significantly improving program development efficiency and maintainability!

In terms of communication, S5 series is called “all-rounder”: it supports EtherCAT high-speed bus, dual BD expansion boards, S485/RS232 serial ports, Type-c debugging interfaces and dual RJ45 network ports, which makes it easy to build a multi-stage network architecture of “Master + Slave + IO Module”. It can easily build a multi-level network architecture of “Master + Slave + IO Module” to meet the communication needs of various industrial sites. Whether it is a stand-alone device or a complex production line, S5 can flexibly cope with it!

1.2 Programming Instructions

This instruction manual mainly describes the specifications, characteristics and usage of S5. Before using the product, please read the manual carefully in order to grasp the characteristics of the product more clearly and use the product more safely. For the use of the user program development environment and the user program design method, please refer to the “LC/MC/SC/S Series PLC Instruction Manual” and “Leadsys Studio/CodeSys Programming and Application Manual” issued by our company, and please refer to the latest version of the information published by (<https://www.Leadshine.com/>).

1.3 Arrival inspection

- Check whether the surface of the product is damaged or not during transportation.
- Check the nameplate models of the drive and motor are what you have ordered.
- Check if it is fully equipped with accessories. Accessories include power supply and motor output connector, control I/O signal connector.

CAUTION



- Neither the damaged nor missing accessories of stepper system are allowed to install.
- Contact Leadshine or local distributor if any failure was found.

2. Product information

2.1 Related Products

S5	Model	EtherCAT	Descriptions
	S508-1616-N	8	CPU unit supporting RS485/RS232/EtherNet*2, 16 inputs (NPN/PNP), 16 outputs (NPN), 6-channel 200KHz high-speed inputs (IN0 to IN5), 6-axis 200KHz high-speed outputs (Out0 to Out5). BD expansion*2, right expansion*32
	S516-1616-N	16	
	S532-1616-N	32	

2.2 Nameplate information

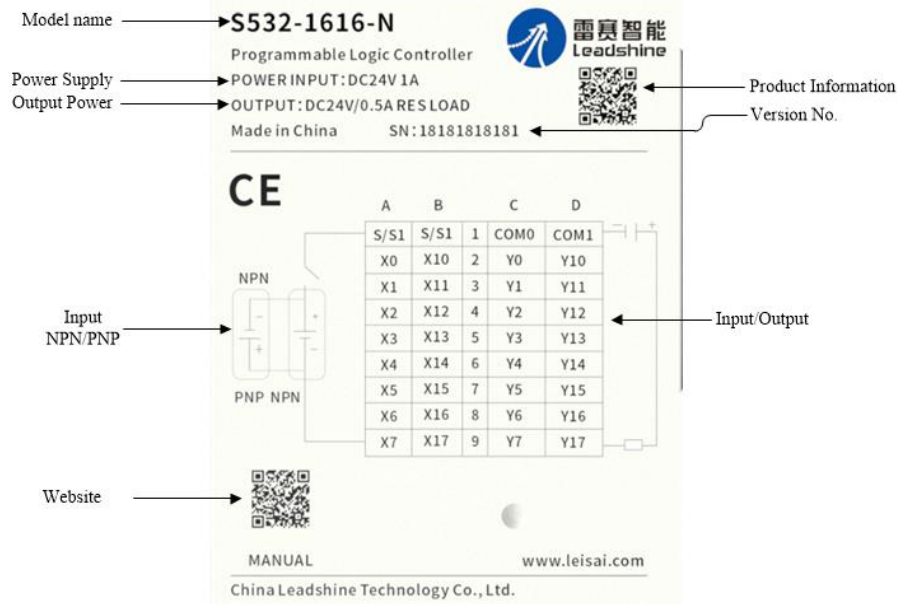

2.3 Part number

Model: **S 5 32 - 1616 - N - XXX**

① ② ③ ④ ⑤ ⑥

① **Product Type**

S: Leadshine Super Series Programmable Logic Controllers

② **Product Series**

1: S1 Series -- Economy

2: S2 Series -- Standard

3: S3 Series -- Pulses

5: S5 Series -- EtherCAT

6: S6 Series -- Flagship

③ **No. of Axis**

Blank: Non-axial

2:2 Axis\4:4 Axis\6:6 Axis\8:8 Axis\10:10 Axis

12:12 Axis\16:16 Axis\32:32 Axis

④ **Ontological IO**

0808: 8 Input/8 Output

1616: 16 Input/16 Output

⑤ **Output Type**

N: NPN

P: PNP

⑥ **Special purpose**

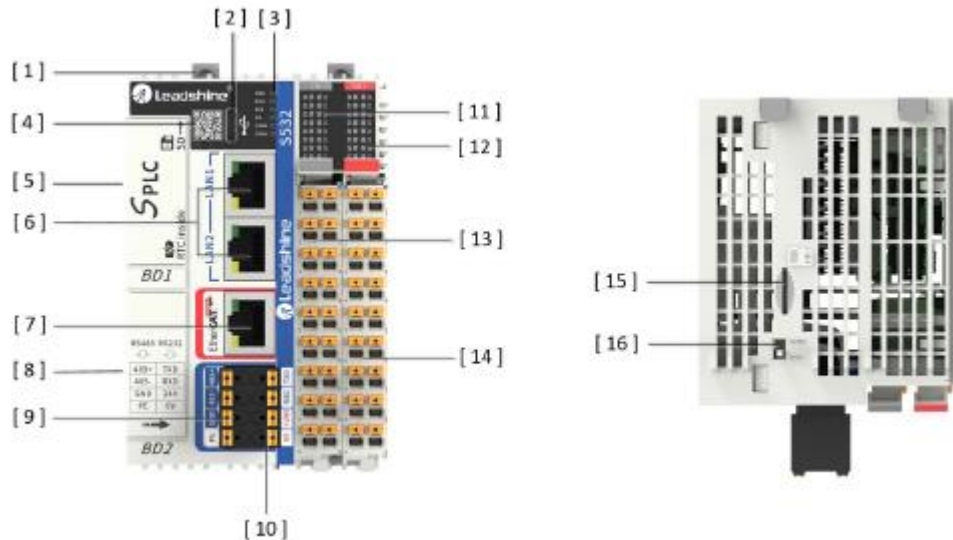
2.4 Parts description

No.	Interface	Name	Definition	Description
[1]	Installed	--	DIN	Push up to lock the catch to the DIN rail, pull down to release it
[2]	USB Port		Type-C Connect	Type-C connector with PC, Default IP: 192.168.88.88 Upload, monitor, download, firmware update, power supply Supports connection of USB flash disk (FAT32 format, max. 32G capacity).
[3]	Running status Indicator light	PWR	Power status	Light up when power on, light off when power off
RUN		System status	Light up when system run, light off when system stop	
ERR		System failure	Indicator light blinks in the event of a non-shutdown failure of the system; Red light illuminates in the event of a system failure, and goes out when the system is normal	
SD		SD Card Status	Insert the SD card, PLC successfully read after the constant light; PLC operation SD card file read/write 10Hz blinking; After completing the program, firmware update, blinking at a frequency of 5HZ for 3 seconds	
COM0		RS485 Communication Status	Indicator light flashes 10Hz when data is received and sent	
COM1		RS232 Communication Status	Indicator light flashes 10Hz when data is received and sent	
[4]	QR Code for Product Information	--	QR Code for Product Information	Scan this QR code to download product 2D/3D drawings, product brochures and other materials in your browser
[5]	BD Board 1	BD 1	Expanded BD board slot 1	Supports S-CAN-485-BD, S-232-485-BD, S-0400-BD, S-0004-N-BD, S-2AD1DA-VI-BD, etc.
[6]	RJ45	EtherNET 0	RJ45 Port 0	Support OPC UA \ MQTT \ API \ Modbus-TCP \ Ethernet/IP \ Socket protocol; Built-in switch function, IP address 192.168.1.3
[6]		EtherNET 1	RJ45 Port 1	
[7]	BUS	EtherCAT	EtherCAT Bus	EtherCAT Bus Master
[8]	BD Board 2	BD 2	Expanded BD board slot 1	Supports S-232-485-BD, S-0400-BD, S-0004-N-BD, S-2AD1DA-VI-BD, etc.
[9]	RS485 Port COM0	485+	RS485_A	Modbus RTU protocol, Free communication protocol, COM0 of the corresponding software
		485-	RS485_B	
		GND	GND	
	RS232 Port COM1	TXD	RS232_T	Modbus RTU protocol, Free communication protocol, COM1 of the corresponding software
		RXD	RS232_R	
		GND	GND	
[10]	Power Port	+24V	Supply Positive	Input DC24V+
		0V	Supply Negative	Input DC24V—
		PE	Ground	Ground

[11]	Input Indicator	Xn	Input Port Indicator	TRUE: light on, FALES: light off
[12]	Output Indicator	Yn	Output Port Indicator	
[13]	Input port	X0-Xn	16 Inputs	16 digital inputs on the body
[14]	Output port	Yn-Yn	16 Outputs	16 digital outputs on the body
[15]	SD Card		16 digital input	Support standard micro SD card, FAT32 format, capacity ≤32GB, specification 15mm×11mm×1mm; Support upgrade firmware, update user program, file read/write and other functions
[16]	DIP Switches	Run/Stop	Run/Stop Dial	RUN: PLC running state; STOP: PLC stop state; 5S any dialing 5 times or more, trigger the RESET function, then the RUN lamp blinks, restores the default IP and releases the corresponding connection.

2.5 Product Specifications

2.5.1 Standard

Event	Program Volume		Address Range
Power	Program Volume	16M Bytes	----
	Region I (%I)	128K Bytes	%IB0 ~ %IB131071
Program data capacity	Region Q (%I)	128K Bytes	%QB0 ~ %QB131071
	Region M (%I)	512K Bytes	%MB0 ~ %MB524287
	Custom Variables	32M Bytes	----
	Power down hold	512K Bytes	----
EtherNet	The EtherNET1/EtherNET2 ports are switch-enabled by default, and the IP addresses are both 192.168.1.3. They can be set to separate IP addresses; Supports OPC UA, MQTT, API, EIP, Modbus TCP (client/server), Ethernet/IP(producer/consumer), Socket protocol; Support with programming software for program upload, download, monitoring and firmware upgrade		
EtherCAT	Supports EtherCAT bus master with up to 127 slaves (including 32 CIA 402 bus axes)		
Serial Port	1 channel RS232 1 channel RS485		
Input	12 channels 200KHz / 4 channels 1KHz		
Output	12 channels 200KHz / 4 channels 1KHz		
PWM	6-channel PWM, Frequency: [1-200000] HZ, Duty cycle [0-1]		
Interrupt	6 channels of external input interrupts, 4 channels of high-speed counting interrupts		
S/S0/S1	S/S0--X0-X7, S/S1--X10-X17		
COM0/COM1	COM0--Y0-Y7, COM1--Y10-Y17		
Extension Module	Right side expansion: supports 32 R3 series modules Supports 2 BD version expansion modules		
Program Language	ST、SFC、LD、IL、CFC、FBD		
Type-C port	Support user program upload, download and firmware upgrade		
SD Card	File reading and writing, program downloads and firmware upgrades		
Power	Rated 15W, PLC startup current >3A		
working temperatures	-20°C~60°C		
protection class	IP20		

2.5.2 Input Port Specifications

The input signal can be a bipolar voltage. When the absolute value of the voltage is below DC5.0V, it is disconnected (OFF); when the absolute value of the input voltage is greater than DC15.0V, it is closed (ON); between DC5.0V ~ DC15V, the signal state is undefined.

Event	Specification Description
Signal Input Type	When S/S0,S/S1 terminals are connected to DC24V: NPN type; When S/S0,S/S1 terminals are connected to DC0V: PNP type;
Input Voltage/Current	DC24V(-15% - +20%), 12.5mA
Input Impedance	1.8KΩ
OFF-ON Statuses	>DC 15V, current 3mA or more
ON-OFF Statuses	<DC 5V, current 1mA or less
Filter time	Software programmable, minimum filtering time 100ns
Public End	S/S0 for IN0-IN7, S/S1 for IN10-IN17
Input Protections	Optical coupling isolation, anti-interference filtering
Narrowest recognized pulse width	1.5μs (including positive and negative pulses, if used as AB phase counting, the phase difference time is required to be greater than 250ns, or the duty cycle is between 40% and 60% at 200K input.)

2.5.3 Output Port Specifications

The output signal is NPN type. When the output is valid (status “ON”), it is a low level state; when the output is invalid (status “OFF”), it is a high level state. One of the high-speed output port support 200KHz frequency; need to ensure that the driver optocoupler input 12mA or more reliable working current.

Event	Specification Description (OUT0-OUT15)
Output Voltage	DC5~24V
Output Current	500mA/channel (peak/full load), single channel common COM max. 2A current
Maximum Output Current	Resistive Load: 0.5A/1 point, 2A/8 points; Inductive Load: 7.2W (24VDC), 24W/8 points; Lamp Load: 5W (24VDC)/point, 18W/8 points
ON/OFF response time	OFF→ON: < 1us, ON→OFF: < 2us
ON/OFF max. leakage current	0.3A/point, 2.4A/8 points 1 set of common terminals
Minimum Load	≥12mA(DC5~24V)
Output protection	Short circuit protection, over current protection, opto-electronic isolation

3. Installation

3.1 Storage and Installation Conditions

3.1.1 Storage condition

- Correctly packaged and store in a clean and dry environment where direct sunlight is avoided.
- Store within an ambient temperature ranging from -20°C to +65°C.
- Store within a relative humidity ranging from 40% to 90% and non-condensed.
- Avoid any type of exposure to corrosive gases.

3.1.2 Operating ambience conditions

- Temperature ranging from 0°C to 50°C. The ambient temperature of drive for long-term reliability should be under 40°C. Please install the drive in a well-ventilated area.
- Operation within a relative humidity ranging from 40% to 90% and non-condensed.
- Vibration lower than 0.15mm at a frequency of 10Hz-55Hz.

<p>CAUTION</p> 	<ul style="list-style-type: none"> ● DO NOT mount the PLC in a location subjected to corrosive or flammable gases, and combustibles. ● Please mount the PLC in an indoor electric control cabinet without liquid where direct sunlight is avoided. ● DO NOT mount the PLC in a location subjected to airborne dust. ● Please ensure grounding wires are securely connected
---	--

3.2 Mechanical Specification

Unit: mm, 1inch=25.4mm

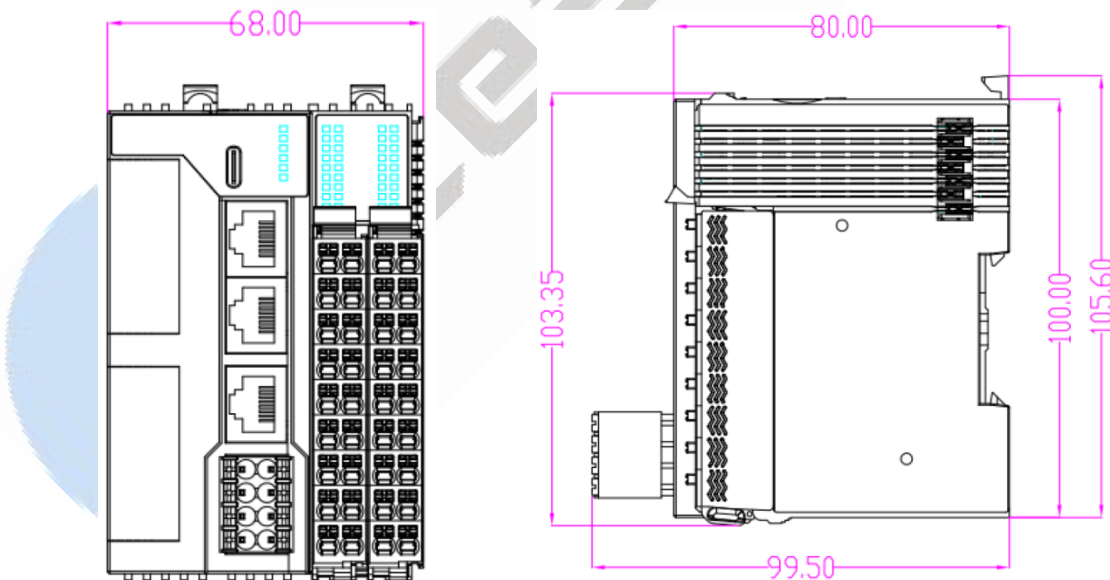

Figure:SC2-C series mechanical drawing

4. Production Specifications

4.1 Electrical Specifications

4.1.1 Caveat

- When wiring I/O signals, avoid bundling them with power cables and other cables that transmit strong interference signals, and route them separately and avoid running them in parallel;
- High-speed I/O ports are recommended to use shielded cables to improve the anti-interference ability, the cable length is recommended to be 3m or less.
- When the output port is connected to relays, solenoid valves and other inductive loads, when the inductive load is suddenly turned off, it will generate a large reverse electromotive force between the contacts and produce arc discharge, which may breakdown the output transistor, the user should be based on the use of the situation, and if necessary, connect the diode in parallel with the load, to extend the service life of the product. Diodes need to meet the reverse voltage is 5 to 10 times the load voltage, forward current is greater than the load current;
- Large capacitive loads are not allowed to be connected to the output ports, otherwise there is a risk of failure when the channel is turned off.

4.1.2 Power requirements

Event	Specification Description
Rated voltage	DC24V
Voltage range	DC20.4V ~ DC28.8V (-15% ~ +20%)
Allowable Instantaneous Power-Off Time	Instantaneous power failure of less than 10ms will continue to operate
Inrush current	10A, DC28.8V
Input protection	Short circuit protection
Rated power	15W

4.2 Input Internal Circuit And Wiring

4.2.1 Input Signal Wiring

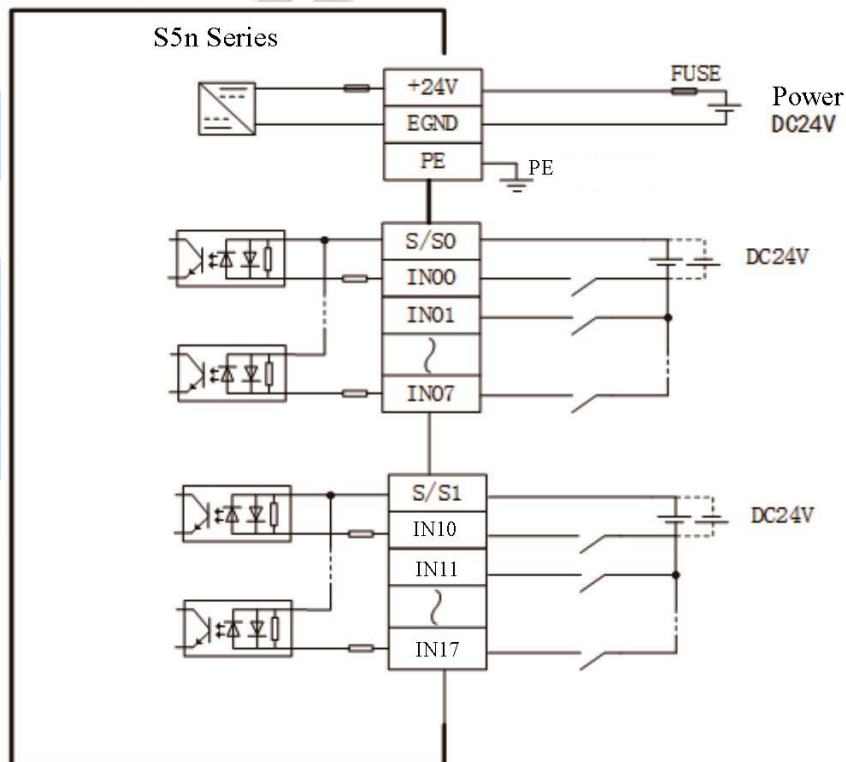

Figure: SC2-C Series Product Input Port Equivalent Circuit

4.2.2 Output Signal Wiring

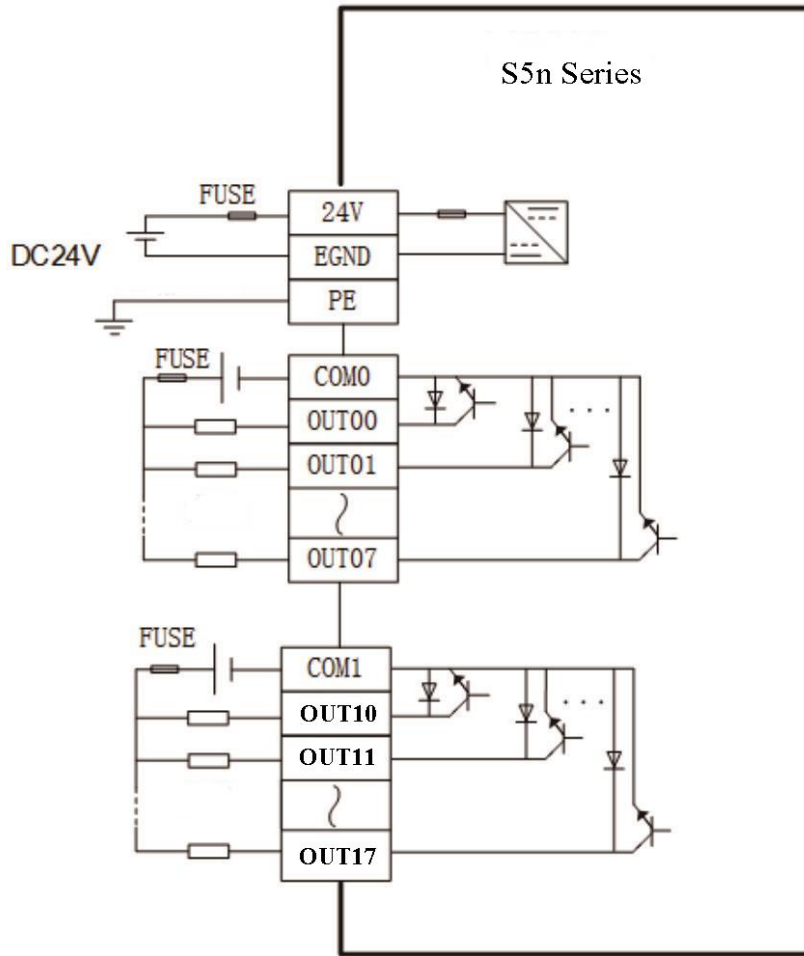

Figure: SC2-C Series Output Port Equivalent Circuit

5. Communications

5.1 Cable Selection and Fabrication

5.1.1 Cable selection and production standards

Applicable models	Name	Wire Diameter	
		GB/mm2	ASTM/AWG
Power Cord	Tubular lugs	0.5 ~ 1.5	16 ~ 24
Signal cable	Tubular lugs	0.5 ~ 1.5	16 ~ 24
Ground wire	Tubular lugs	≥2	14 ~ 15

5.1.2 Steps for making tubular cables

- 1) Remove the cable insulation, the exposed copper part is 11-14mm, and thread the cable into the wire lug sleeve;
- 2) The conductor part of the cable is threaded into the round holes of the lugs and crimped using the crimping pliers recommended by the lug manufacturer;

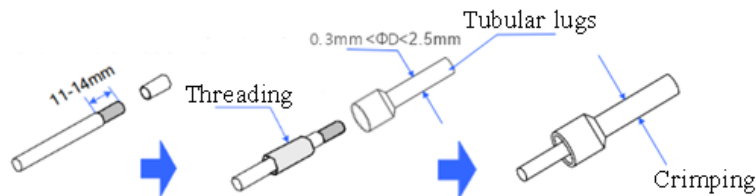

5.2 EtherNet

- The PLC Ethernet port can be connected to a hub or switch through an Ethernet cable, and connected to other network devices through the hub or switch to realize multi-point connection. Point-to-point connection with computers, HMIs, etc. is also possible via 1 Ethernet cable.
- To improve the reliability of equipment communication, Ethernet requires the use of super category 5 shielded twisted pair cable.

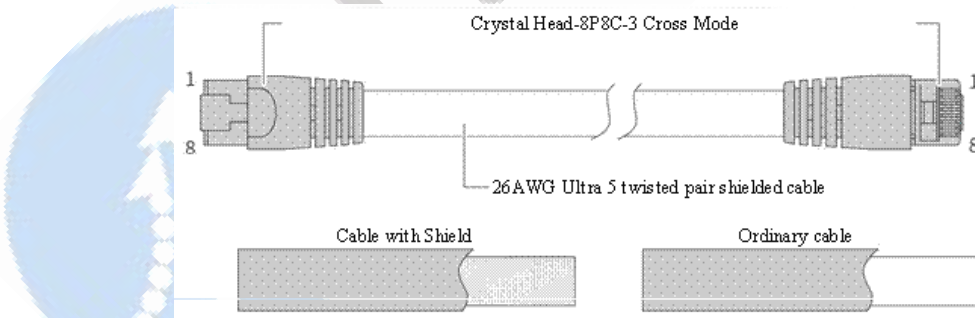

Pin	Function	Description	Communication interface diagram
1	Tx+	Send Data+	
2	Tx-	Send Data-	
3	Rx+	Receive Data+	
4	--	Do not use	
5	--	Not used	
6	Rx-	Receive Data-	
7	--	Not used	
8	--	Not used	

- Recommended cables for EIA/TIA568A, EN50173, ISO/IEC11801, EIA/TIAbulletin TSB, EIA/TIA SB40-A & TSB36 standards

5.3 EtherCAT

5.3.1 EtherCAT bus specification description

- EtherCAT bus communication cycles:

Bus period	N0. of axes	Number of slaves
Minimum cycle 1ms	8 CIA 402 axis synchronization	127 (in linear topology mode)
cycle 2ms	16 CIA 402 axis synchronization	
cycle 4ms	32 CIA 402 axis synchronization	

- EtherCAT port

Event	Specification Description
Communication standard	IEC61158 Type12
Support Services	CoE (PDO、SDO)
Synchronization Methods	FreeRun\SM-Synchronous\DC-Synchronous
Physical Layer	100BASE-TX
Transmission Speed	100Mbit/s (100Base-TX)
Duplex Mode	Full duplex
Topology	Line, Bus and Star
Transmission Media	Network cables
Transmission Distance	Less than 100m between two nodes
EtherCAT frame length	44 byt to 1498 byt
Process data	Single Ethernet frame up to 1486 bytes, maximum frame size 4

5.3.2 Wiring

For Ethernet connection cables, please use shielded twisted-pair cables (aluminum foil + braided mesh double-shielded direct-connect cables) of category Super Category 5 or higher, as shown in the figure:

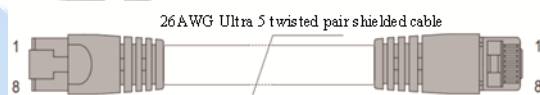

5.3.3 Pin Definitions

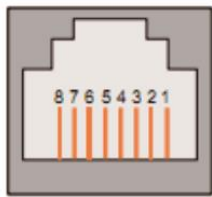
Pin	Function	Description	Communication interface diagram
1	Tx+	Send Data+	
2	Tx-	Send Data-	
3	Rx+	Receive Data+	
4	--	Do not use	
5	--	Not used	
6	Rx-	Receive Data-	
7	--	Not used	
8	--	Not used	

5.3.4 Technology

100% conductivity test, no shorts, breaks, misalignments and poor contacts, the following cable specifications are recommended:

EtherNet cable specification requirements:

Event	Specification Description
Cable Type	Flexible Crossover Cable, S-FTP, Category 5 Ultra
Standard	EIA/TIA568A, EN50173, ISO/IEC11801 EIA/TI Abulletin TSB, EIA/TIA SB40-A&TSB36
Wire cross-section	AWG26
Wire Type	Unshielded twisted pair
thread count	4

5.4 RS485 & RS232 Serial Ports

The RS485 communication port and RS232 communication port share a terminal block, the left side of the terminal is for RS485 communication and the right side of the terminal is for RS232 communication, as shown in the figure:

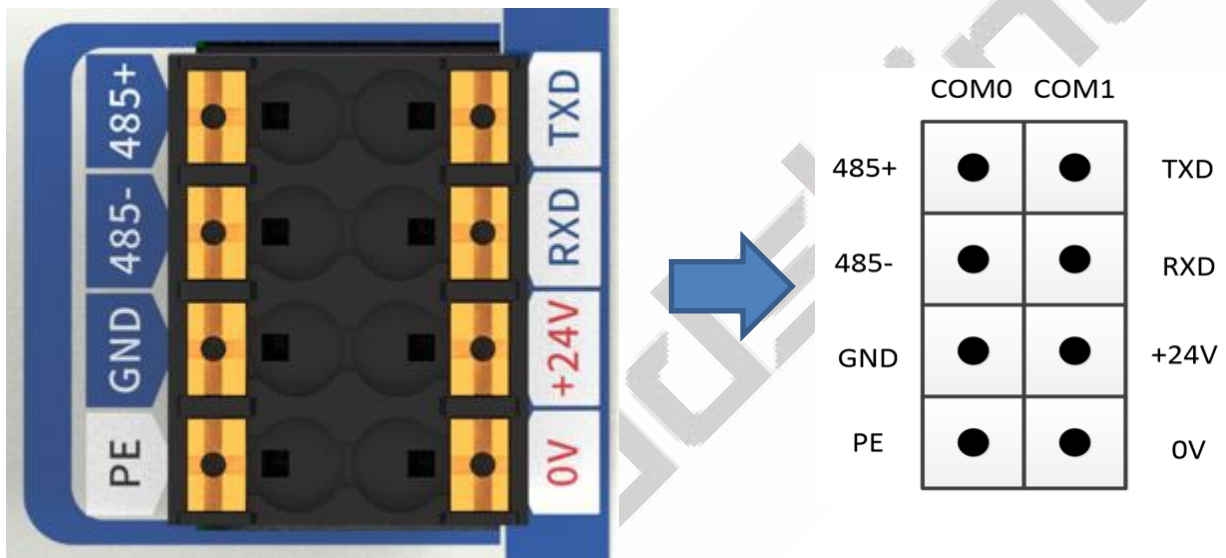

RS485 and RS232 Port Descriptions

Left		Right	
Mark	Function	Mark	Function
485+	A: RS485 differential positive signal	TXD	RS232 communication transmit data pin
485-	B: RS485 differential negative signal	RXD	RS232 communication receive data pin
GND	Signal ground common to RS485 and RS232 communication	+24V	Power supply DC24V input (+)
PE	PE	0V	Power supply DC0V input (-)

RS485 & RS232 Interface Specifications

Event		Specification Description
Physical layer	COM0	RS485, master or slave
	COM1	RS232, master or slave
Terminating resistor	COM0	RS485 built-in 120Ω, enabled by dialing code to ON state
Baud bps		4800 / 9600 / 19200 / 38400 / 57600 / 115200 bit/s
Max. communication distance	COM0	100m
	COM1	15m
Topological structure	COM0	Line, Bus and Star
	COM1	Point-to-Point
Max. number of slaves	COM0	31
	COM1	1
Short-Circuit protection	COM0	RS485 supports DC24V misinsertion protection
	COM1	RS232 not supported
Transmission medium		Flexible Crossover Cable, S-FTP, Category 5 Ultra

RS485 bus connection topology is shown in the figure below, RS485 bus recommended to use shielded twisted-pair connection, 485+, 485- using twisted-pair connection; bus ends were connected to the 120 Ohm terminal matching resistor to prevent the signal from reflecting; all the nodes of the 485 signal reference ground is connected to the same; up to 31 nodes are connected to the node, and each node branch line distance to be less than 3 meters.

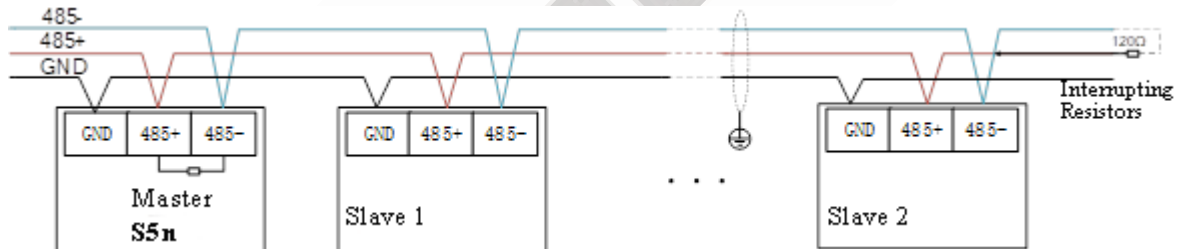

When using RS232 serial communication, you need to connect the data receive pin of the host computer to the data transmit pin of the serial device, the data transmit pin of the host computer to the data receive pin of the serial device, and the direct connection of the ground pin between the host computer and the serial device.

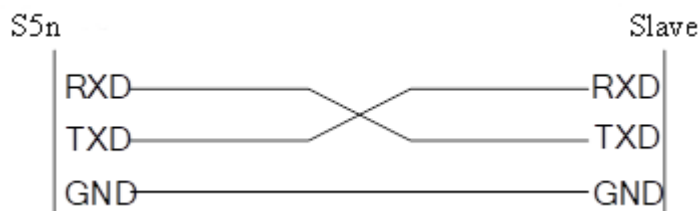

6. Run and maintenance

6.1 Run and shutdown operations

After the program is written to the PLC, follow the steps below to perform the switching operation.

When you need to run the system after program writing with the PLC in the STOP state:

- ① Set the RUN/STOP switch to the RUN position;
- ② Confirm that the RUN indicator is normally lit and the color is green;
- ③ When you need to stop running, return the RUN/STOP switch to the STOP position, at this time the RUN indicator is off, and you can also stop running through the upper computer background.

6.2 Restoring the Factory Default IP Address

The factory default IP address of the host is 192.168.1.3. If the address has been modified, before communicating with another PC in the network, if the last modified IP address is forgotten and the communication cannot be matched, the following operations can be carried out at this time:

- ① Connect the PLC host through the Type-C interface in the presence of a PC environment, and set up the IP address of the host through the Leadsys Studio software;
- ② In the absence of a PC environment, you can quickly switch the state of the “RUN/STOP” switch to trigger the initialization of the host's IP address setting. IP address; default IP of Type-C interface: 192.168.88.88;
- ③ In the absence of PC environment, you can quickly switch the state of “RUN/STOP” switch to trigger the initialization of IP address setting of the host computer, and the trigger criterion is: the number of toggle times reaches 5 or more times within 5 seconds.

6.3 RTC Battery Maintenance

RTC Battery for Real Time Clock RTC Timing.

- ① If the battery is not installed or is in a discharged state, the clock stops timing;
- ② The maximum life of the battery is 3 years, depending on the usage environment. When the battery is about to run out of power, the front panel display will report Battery voltage is too low, please replace it in time.

6.4 Replacement of batteries

- ① Set the PLC dip switch to STOP to stop operation and turn off the power to the PLC;
- ② Open the controller plastic housing cover and remove the old battery with tweezers;
- ③ Slide the new battery into the battery bay, followed by closing the controller molded case cover.

Note: The battery replacement operation is best done under power supply conditions. If the PLC has lost power, replace the battery within 30 seconds of unplugging the battery so that the RTC clock can remain normal.

6.5 Burning User Programs on USB Flash Drives

Compile and generate the Runtime system file in Leadsys Studio or Codesys software, store it in the root directory of the USB flash disk, and then load the USB flash disk onto the PLC host. Power off and restart the PLC to update the program. When the program download is completed, the RUN indicator will light up normally, if the download fails or the program does not run, the RUN indicator will go out.

6.6 Burning user programs through the network port

This function is used when the original PLC code program is not provided, but only the PLC running program. PLC application files (.app and .crc) are compiled in Leadsys Studio software, and can be uploaded or downloaded from Leadsys Studio software, menu=>Tools=>Firmware Upgrade, under IEC Controller File Management Tools.

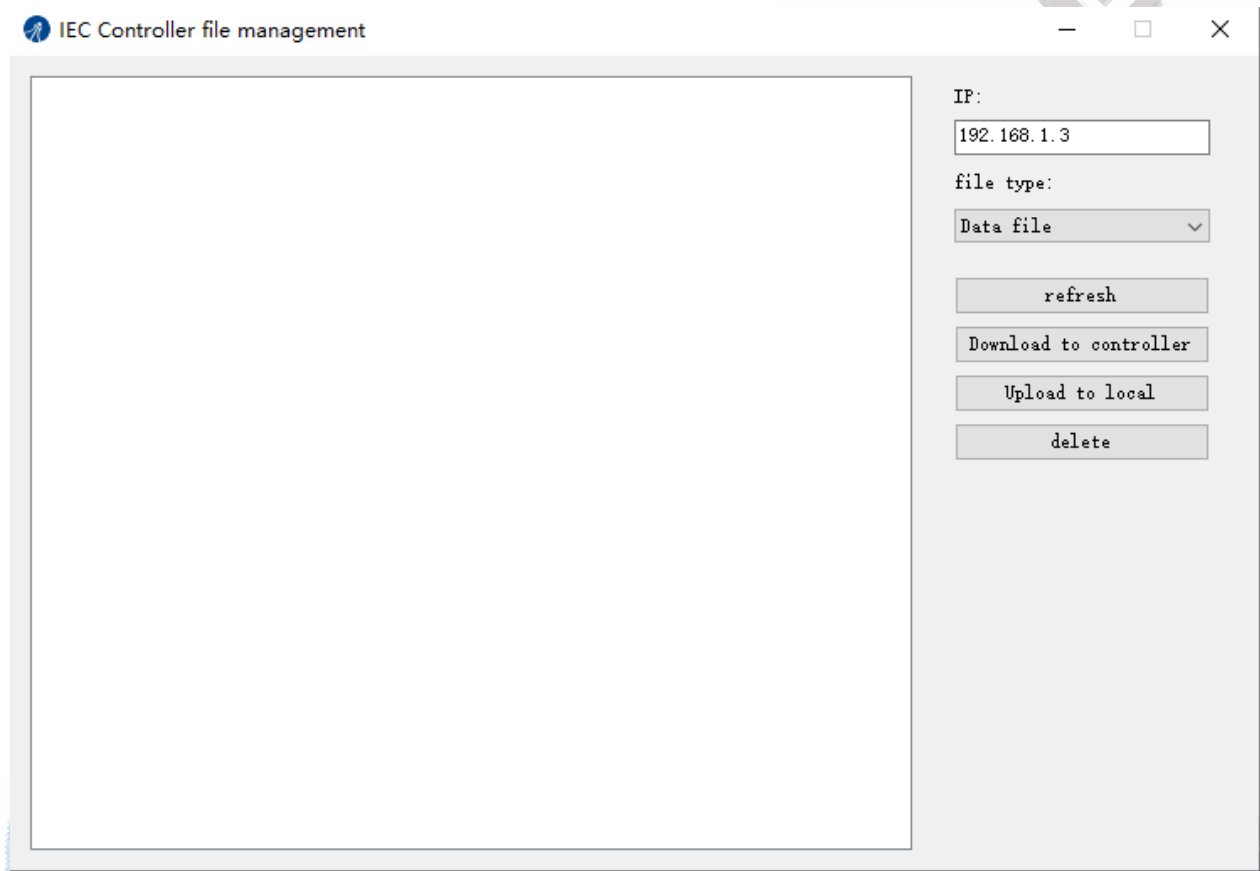

Contact us

Leadshine Technology Co., Ltd.

Headquarters Address:

15-20/F, Block B, Nanshan i-Valley, No.3157, Nanshan District,
Shenzhen City, Guangdong Province, China

Tel: +86 755 26411692

Fax: +86 755 26402718

Website: www.leadshine.com

Emails: sales@leadshine.com

Leadshine Global Retailers Network



Get in touch with us or any of your local Leadshine certified retailers by visiting our global website.

Technical Support

Tel: 86-755-2641-8447

86-755-2641-8774 (Asia, Australia, Africa)

86-755-2665-5136 (North and South America)

86-755-8654-2465 (Europe)

Fax: 86-755-2640-2718

Email: tech@leadshine.com

Author Email: Sean@leadshine.com

Sales Hot Line

Tel: 86-755-2641-7674 (Asia, Australia, Africa)

86-755-2641-7617 (North and South America)

86-755-2640-9254 (Europe)

Email: sales@leadshine.com

Leadshine
overseas



Leadshine
America, Inc.

North America Office

Address: 26050 Towne
Centre Dr. Foothill
Ranch California
United States

Tel: 1-949-608-7270

Fax: 1-949-638-7298

Website:

www.leadshineusa.com

Emails:

sales@leadshineusa.com