

ELD2-RS Series DC Servo Drive

User Manual



Foreword

Thank you for purchasing Leadshine ELD2-RS series DC Servo drives. This manual will provide information on the ELD2-RS series servo products regarding product safety & specifications, installations & wiring, tuning & problem diagnostics.





Please contact us at tech@leadshine.com if you need further technical support.

Incorrect operation may cause unexpected accident, please read this manual carefully before using product.

- ✧ We reserve the right to modify equipment and documentation without prior notice.
- ✧ We won't undertake any responsibility with any customer's modification of product and the warranty of product will be canceled at the same time.

Safety Precautions

Please read the safety instructions carefully before using the products and pay attention to the safety signs.

	Might incur death or serious injury
	Might cause injury to operating personals or damage to equipment
	Might cause damage to equipment
	Hot surface. Do not touch
	Protective Earth

Safety instructions

Warning

- ✓ The design of the product is not to be used in mechanical system which may incur health hazard.
- ✓ Users should be aware of the product safety precautions during design and installations of the equipment to prevent any unwanted accident.

Upon receiving

Caution

- ✓ The use of damaged or faulty product(s) is prohibited.
- ✓ Please refer to item checklist. If the labels don't match, please do not install.

Transportation**Caution**

- ✓ Please provide storage and transportation under protected conditions.
- ✓ Do not stack the products too high up to prevent toppling.
- ✓ The product should be packaged properly during transportation,
- ✓ Do not hold the product by the cable, motor shaft or encoder while transporting it.
- ✓ The product should be protected from external forces and shock.

Installation**Caution****Servo drive and Motor:**

- ✓ Do not install around combustibles to prevent fire hazard.
- ✓ Avoid vibration and impact.
- ✓ Do not install products that are damaged or incomplete.

Servo drive:

- ✓ Please install in electrical cabinet with sufficient protection from outside elements.
- ✓ Reserve sufficient gap as per the installation guide.
- ✓ Make sure to have good heat sinking.
- ✓ Avoid dust, corrosive gas, conductive object or fluid and combustibles.

Servo Motor:

- ✓ Make sure installation is tight to prevent it from loosening.
- ✓ Prevent fluid from leaking into motor and encoder.
- ✓ Protect motor from impact to avoid damaging encoder.
- ✓ Motor shaft should not bear the load beyond the limits as specified.

Wiring**Warning**

- ✓ Participate installation personals should have sufficient training in product installation safety.
- ✓ Please power off and wait for 10 minutes to make sure a full discharge of electricity.
- ✓ Servo drive and motor must be connected to ground.
- ✓ Connect the cables only after servo drive motor installed correctly
- ✓ Make sure the wires are properly managed and insulation layer is not torn to prevent electrocution.

**Caution**

- ✓ Wiring must be correctly connected to prevent damage to product(s)
- ✓ Servo motor U, V, W terminal should be connected correctly and NOT connected directly to an AC power supply.
- ✓ Capacitor, inductor or filter shouldn't be installed between servo motor and servo drive.
- ✓ Connecting wires or any non-heat resistant components should be put near to heat sink of the servo drive or motor.
- ✓ The flyback diode which is connected in parallel to output signal DC relay must not be connected in reverse.

Tuning and running**Caution**

- ✓ Make sure the wirings of servo drive and servo motor are installed and fixed properly before powering on.
- ✓ On the first time tuning of the product, it is recommended to run unloaded until all the parameter settings are confirmed to prevent any damage to the product or machine.

Usage**Caution**

- ✓ Please install an emergency stop button on machine to stop operation immediately if there is an accident.
- ✓ Please make sure machine is stopped before clearing an alarm.
- ✓ Servo drive must be matched with specified motor.
- ✓ Frequent restart of the servo system might incur damage to the product.
- ✓ Servo drive and motor will be hot to touch shortly after power off. Please be careful.
- ✓ Modification(s) to servo system is prohibited.

Error Handling**Warning**

- ✓ Please wait for 5 minutes after powering off for the electricity to be fully discharged before uninstalling the cables.
- ✓ Participate maintenance personals should have sufficient training in maintenance and operation of this product series.

**Caution**

- ✓ Please handle the error before clearing an alarm.
- ✓ Keep away from machine after a restart upon alarm. Mechanical axis might suddenly move. Such hazard should be prevented during the utilization of the product.

Model Selection**Caution**

- ✓ Rated torque of the servo motor should be higher than continuous designated torque when fully loaded.
- ✓ Load inertia ratio of the motor should be lower or equals to recommended value for specified models
- ✓ Servo drive must be matched with specified motor.

Warranty Information

Available for

Leadshine overseas warranty only covers Leadshine DC servo products that are obtained through **Leadshine certified sales channel outside of China.**

Warranty claim

- All Leadshine DC servo products (Servo drives and motors) overseas enjoy **18-month** warranty period.
- Due to unforeseen circumstances in different sales regions around the globe, we recommend users to seek technical support from directed sales channel as any warranty claim or repair services may be required.
- Please be informed that any maintenance/repair work that is outside of the warranty claim conditions might incur some charges and to be confirmed before product(s) is being sent in.
- The duration required for maintenance work to be done is to be confirmed after initial check-up but we reserve the right to prolong the repair duration if needed.
- Discontinued products within warranty period will be replaced with a product of similar specifications.

Steps to warranty claim

1. Visit Leadshine global site www.leadshine.com to look for local certified sales channel.
2. Contact designated sales channel to check if any fee might incur. May include repair fee, spare part cost or shipping cost.

Circumstances where warranty claim is not available

- Damage/Loss due to occurrence of natural or man-made disaster such as fire, flood or earthquake.
- Installation or wiring error
- If there is any modification done to the product
- Warranty label on products is torn or not existing
- Not a product bought from Leadshine certified global network of retailers/distributors.

Before warranty claim

- Please backup device parameters before any repair work/warranty claim. Leadshine and Leadshine certified retailers/distributors will not be held responsibilities for any data loss.
- If available, please send product back in original packaging or make sure it is well packaged to prevent any damage to the product during shipping.

Leadshine Technology Co.,Ltd. and its certified sales channel reserved the final right of the interpretation of the warranty information.

TABLE OF CONTENT

CHAPTER 1 INTRODUCTION	9
1.1 Product Introduction	9
1.2 Model Number Structure	10
1.2.1 Servo Drive	10
1.2.2 Servo Motor	10
1.3 Servo Drive Technical Specifications	11
1.4 Servo Drive Ports and Connectors.....	12
1.5 Motor Ports and Connectors.....	13
CHAPTER 2 INSTALLATION & WIRING	14
2.1 Servo Drive Installation	14
2.1.1 Servo drive installation environment	14
2.1.2 Servo drive dimension	14
2.2 Servo Motor Installation	17
2.2.1 Installation conditions.....	17
2.2.2 Precautions during installation	17
2.3 ELD2-RS Wiring Diagram	18
2.4 Servo Drive Ports	19
2.4.1 CN1 I/O Signal Port	21
2.4.2 CN3/CN4 Power supply & Regenerative Resistor Port	24
2.4.3 CN5 Modbus RS485 Communication Port.....	24
2.4.4 CN6 Safe Torque Off (STO) Port	25
2.4.5 CN7 RS232 Tuning Port.....	26
2.4.6 CN9 Logic Circuit Power Supply Port	27
2.4.7 ENC Encoder Feedback Port	27
2.4.8 ID spin dial RSC.....	28
2.4.9 Baud rate/Terminal resistor switch SW	28
2.5 Cable Selection	29
2.5.1 Motor Power Cable	29
2.5.2 Motor Encoder Cable	32
2.5.3 Motor Brake Cable	34
2.5.4 Drive Communication Cable.....	34
2.5.4 Tuning Cable	34
2.6 Regenerative Resistor Selection	35
CHAPTER 3 PARAMETER	39
3.1 Parameters list	39
3.2 Parameters description	50
3.2.1 [Class 0] Basic Settings.....	50
3.2.2 [Class 1] Gain adjustments.....	57
3.2.3 [Class 2] Vibration suppression	63
3.2.4 [Class 3] Velocity/Torque control	67

3.2.5 [Class 4] I/O Monitoring Settings	74
3.2.6 [Class 5] Extension Settings	81
3.2.7 [Class 6] Other settings	85
3.2.8 [Class 7] Factory settings	89
3.2.9 [Class 8] PR control parameters	90
3.2.10 [Class 9] PR control path parameters	99
3.2.11 [Class B] Status Parameters	115
CHAPTER 4 CONTROL MODE	118
4.1 Position control	119
4.1.1 Pulse input and direction settings	120
4.1.2 Electronic Gear Ratio	121
4.1.3 Position command filter	122
4.1.4 Encoder feedback output	124
4.1.5 Positioning completed INP signal output	125
4.2 Velocity control mode	126
4.2.1 Velocity command input control	127
4.2.2 Velocity command acceleration/deceleration	129
4.2.3 Velocity reached signal AT-SPEED output	130
4.2.4 Velocity coincidence V-COIN signal output	131
4.2.5 Zero Speed Clamp	131
4.3 Torque control	132
4.3.1 Torque command input control	133
4.3.2 Torque velocity limit	135
4.3.3 Torque limit (TL-SEL)	135
4.4 Hybrid Control Mode	136
CHAPTER 5 APPLICATION CASE	137
5.1 Gain Adjustment	137
5.2 Inertia ratio identification function	139
5.3 Auto gain adjustment	142
5.4 Manual gain adjustment	147
5.4.1 Parameters adjustment under different control modes	149
5.4.2 Gain switching	151
5.5 3rd gain switching	155
5.6 Model following control	156
5.7 Feedforward gain	157
5.7.1 Velocity feedforward	157
5.7.2 Torque feedforward	158
5.8 Friction compensation function	160
5.9 Safety Functions	161
5.9.1 Max. motor rotational speed limitation	161
5.9.2 Max. duration for motor to stop after disabling	162
5.9.3 External brake deactivation output signal BRK-OFF	162
5.9.4 Servo stopping mode	164
5.9.5 Emergency stop function	164

5.10 Vibration Suppression	166
5.10.1 Mechanical resonance suppression	166
5.10.2 End vibration suppression	170
5.11 Multiturn absolute encoder	171
5.11.1 Parameters setting.....	171
5.11.2 Read absolute position.....	172
5.11.3 Absolute Encoder Related Alarm.....	174
5.12 Regenerative resistor settings.....	175
CHAPTER 6 MODBUS COMMUNICATION	176
6.1 Communication connection	176
6.2 Modbus RS485 communication parameters and ports	177
6.3 Modbus Protocol.....	179
6.3.1 Read Data 0x03.....	179
6.3.2 Write single data 0x06	179
6.3.3 Write multiple data 0x10	180
6.3.4 Reply error.....	181
6.3.5 Auxiliary function parameters.....	181
6.3.6 Alarm info parameters.....	182
6.4 Frequently occurred issues and solutions with RS485 communication.	183
CHAPTER 7 PR MODE	186
7.1 PR functions introduction.....	187
7.2 Control parameters	188
7.3 PR Motion.....	190
7.3.1 Homing.....	190
7.3.2 Position limit and emergency stop	195
7.3.3 JOG.....	195
7.3.4 Path motion	196
7.4 PR Control.....	199
7.4.1 PR module in Motion Studio.....	199
7.4.2 Physical I/O	201
7.4.3 485 communication	203
7.4.4 Path trigger	205
7.5 PR motion	206
7.5.1 Trigger using physical I/O	206
7.5.2 Control using 485 communication	207
CHAPTER 8 WARNING AND ALARM	209
8.1 Servo Drive alarm indicator.....	209
8.2 Servo drive alarm	210
8.3 Alarm Handling.....	211
8.4 Alarm clearing	222
8.4.1 Servo Drive Alarm Clearing	222
CONTACT US	223

Chapter 1 Introduction

1.1 Product Introduction

ELD2-RS Series DC Servo Product is a new DC servo drivers and motors product range that we have proudly developed at Leadshine Technology Co.,Ltd. This product series provides more in demanded functionalities and control.

ELD2-RS Series DC Servo Drive comes with voltage rating of 24 to 70VDC and current rating from 5A up to 60A (max. peak current: 180A). This series supports Modbus communication protocol in addition to pulse + direction input control. Using RS485 protocol, multi axis network of ELD2-RS series servo drive can be realized and controlled from 1 single master device.

ELD2-RS series DC Servo Drive also comes with new ELVM series DC servo motors with 17-bit magnetic absolute and 2500-line incremental encoder which offers better accuracy and stability.

First time user of the ELD2-RS series servo products can refer to this manual for more information on this product that cannot be covered in this short introduction. For further technical support, please do contact us or any local Leadshine certified retailers on Contact Us page.

1.2 Model Number Structure

1.2.1 Servo Drive



No.	Description	
①	Series No.	ELD2: DC Servo Drive Series
②	Communication protocol	RS: Pulse train + Modbus RTU CAN: CANopen + Analogue
③	Power Rating	7020: 24-70VDC, rated current 20A 7030: 24-70VDC, rated current 30A
④	Type	B: Holding brake output <i>Blank</i> : Without holding brake output

1.2.2 Servo Motor

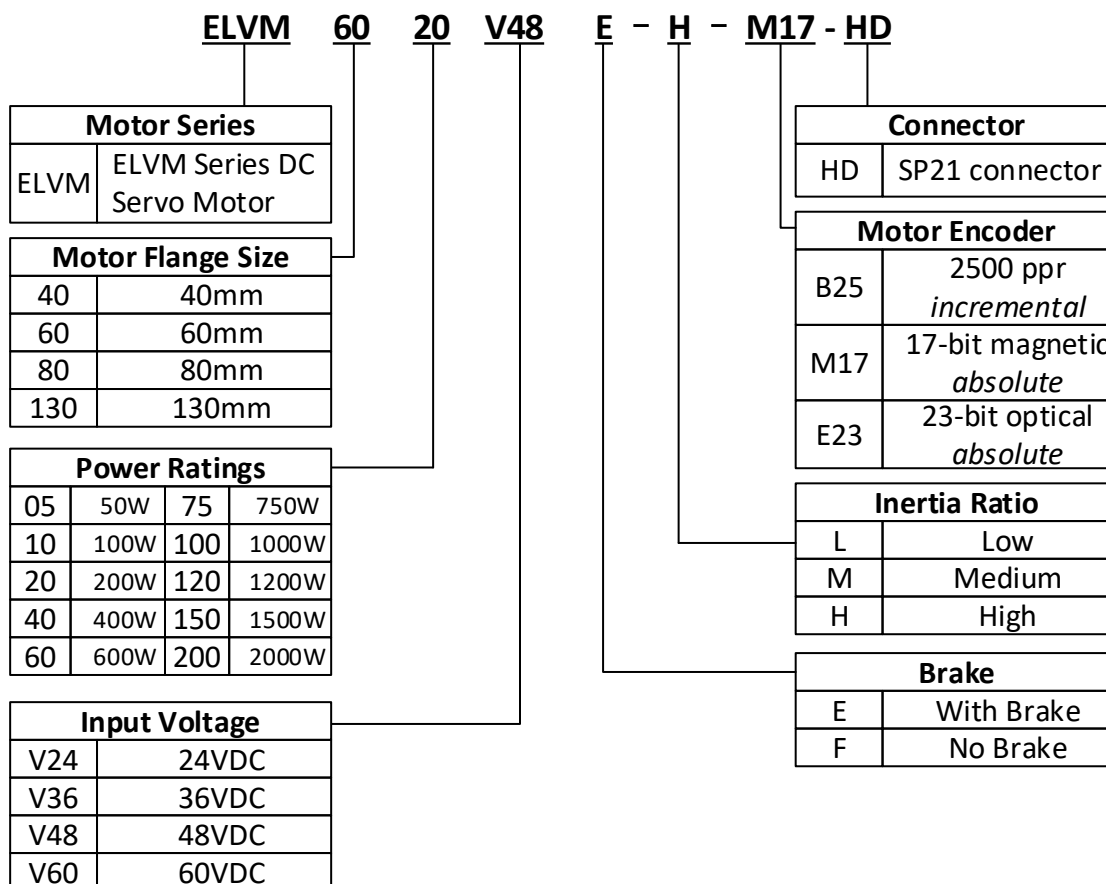

1.3 Servo Drive Technical Specifications

ELD2-RS series	RS7005B	RS7010B	RS7015B	RS7020B	RS7030B
Rated Current (Arms)	5	10	15	20	30
Peak Current (Arms)	21	42	45	80	90
Dimension(mm)	118*79.5*25.5		175*100.5*33		
ELD2-RS series	RS7040B		RS7060B		
Rated Current (Arms)	40		60		
Peak Current (Arms)	120		180		
Dimension(mm)	194*103*41				
Logic Power Supply	24VDC				
Safe Torque Off (STO)	STO SIL3				

Main power supply	24 ~ 70VDC
Direct Drive Holding Brake	Yes
Drive mode	SVPWM sinusoidal wave drive
Velocity regulation ratio	5000:1
Electronic gear ratio	1 ~ 32767/1 ~ 32767
Matching encoders	Hall signal UVW + ABZ or RS485 encoder (Tamagawa protocol)
Input	2 pulse differential 5V Digital input (Pulse+direction) 4 configurable NPN/PNP 24V Digital Inputs: DI3-DI6
	<ol style="list-style-type: none"> 1. Servo enabled (SRV-ON) 2. Positive limit switch (POT) 3. Negative limit switch (NOT) 4. Clear Alarm (A-CLR) 5. Gain switching (GAIN) 6. Deviation counter clearing (CL) 7. Command pulse prohibition(INH) 8. Crossover frequency input switching(DIV1) 9. Internal command velocity selection(INTSPD) 10. Zero speed clamp(ZEROSPD) 11. Velocity sign(VC-SIGN) 12. Torque sign(TC-SIGN) 13. Emergency Stop (E-STOP)
Output	1 holding brake output; 2 configurable single-ended NPN/PNP 24V, 8mA digital outputs
	<ol style="list-style-type: none"> 1. Alarm (ALARM) 2. Servo ready (SRDY) 3. External brake off (BRK-OFF) 4. Positioning completed (INP1) 5. Reached velocity(AT-SPEED) 6. Zero speed position (ZSP) 7. Velocity coincidence (V-COIN) 8. Position command (P-CMD) 9. Velocity command (V-CMD)
Alarm	Current circuit error, DC bus overvoltage, DC bus undercurrent, overcurrent, overcurrent on IPM, motor overload, regenerative resistor overload, encoder disconnected, encoder initialization error, encoder data error, excessive position deviation, overspeed, I/O configuration error, EEPROM parameter saving CRC checksum error, positive/negative position limit valid, forced alarm input valid
Indicator light	Red & Green LED

Tuning Software	Motion Studio 2	
Motion Studio 2	Configure parameters for current, position and velocity loop. Parameter uploading using .lsr parameter files. Drive and motor data monitoring using oscilloscope.	
Communication Port	RS-232 , 1 : 1 ; RS485 , 0 : N ($0 \leq N \leq 127$) , Modbus protocol	
Load-Inertia	Smaller than 20 times motor inertia	
Dimension	175*100*27 mm	118*79.5*25.5 mm
Environmental requirements	Storage condition	Avoid direct sunlight. Keep away from heat generating devices, dust, oil, corrosive liquid/gas and places with strong vibration or high humidity. Prohibit combustible gas and conductive material waste.
	Temperature	-20°C ~ +45°C (Please allow air circulation if >45°C)
	Storage temperature	- 20°C ~ + 65°C
	Humidity	40—90%RH (Condensation free)
	Installation	Vertical and level to ground

1.4 Servo Drive Ports and Connectors

ELD2-RS Series Servo Drive (7005B/7010B/7015B/7020B/7030B)

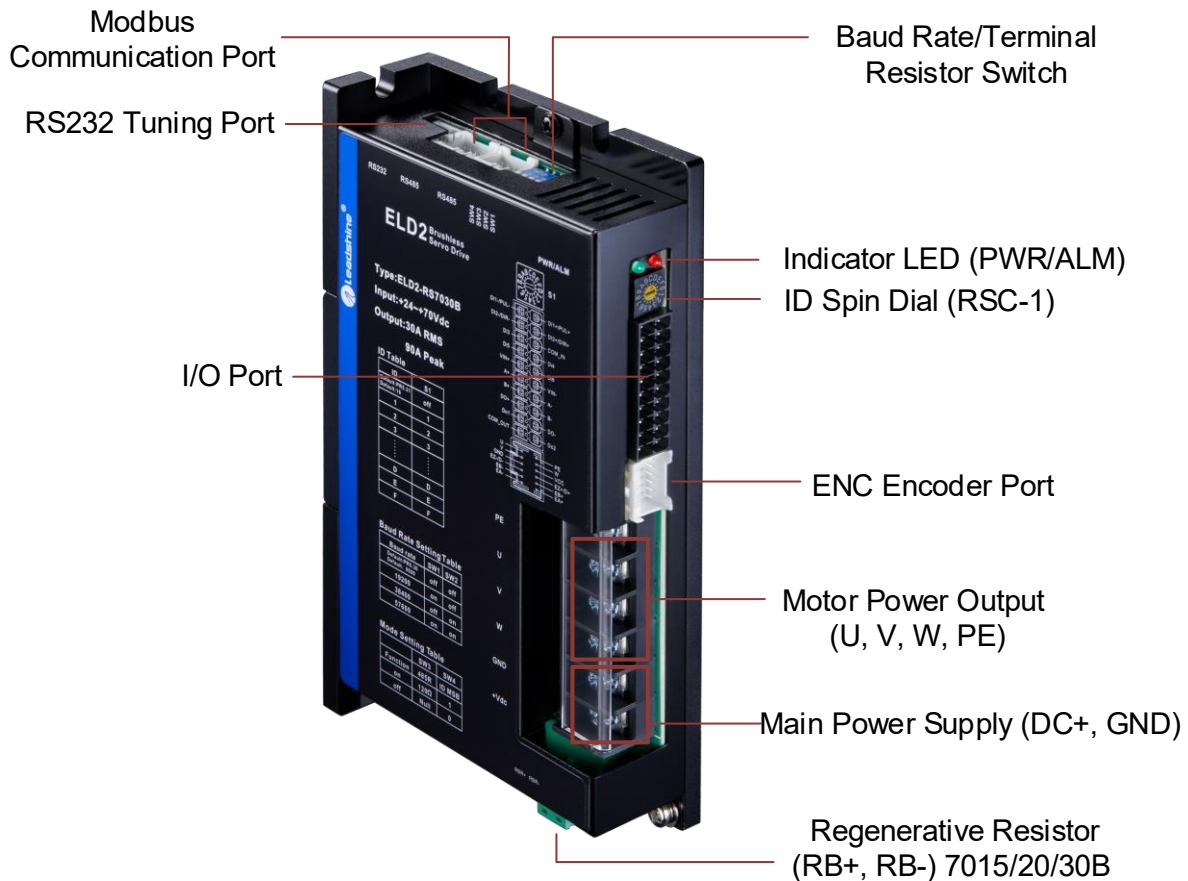

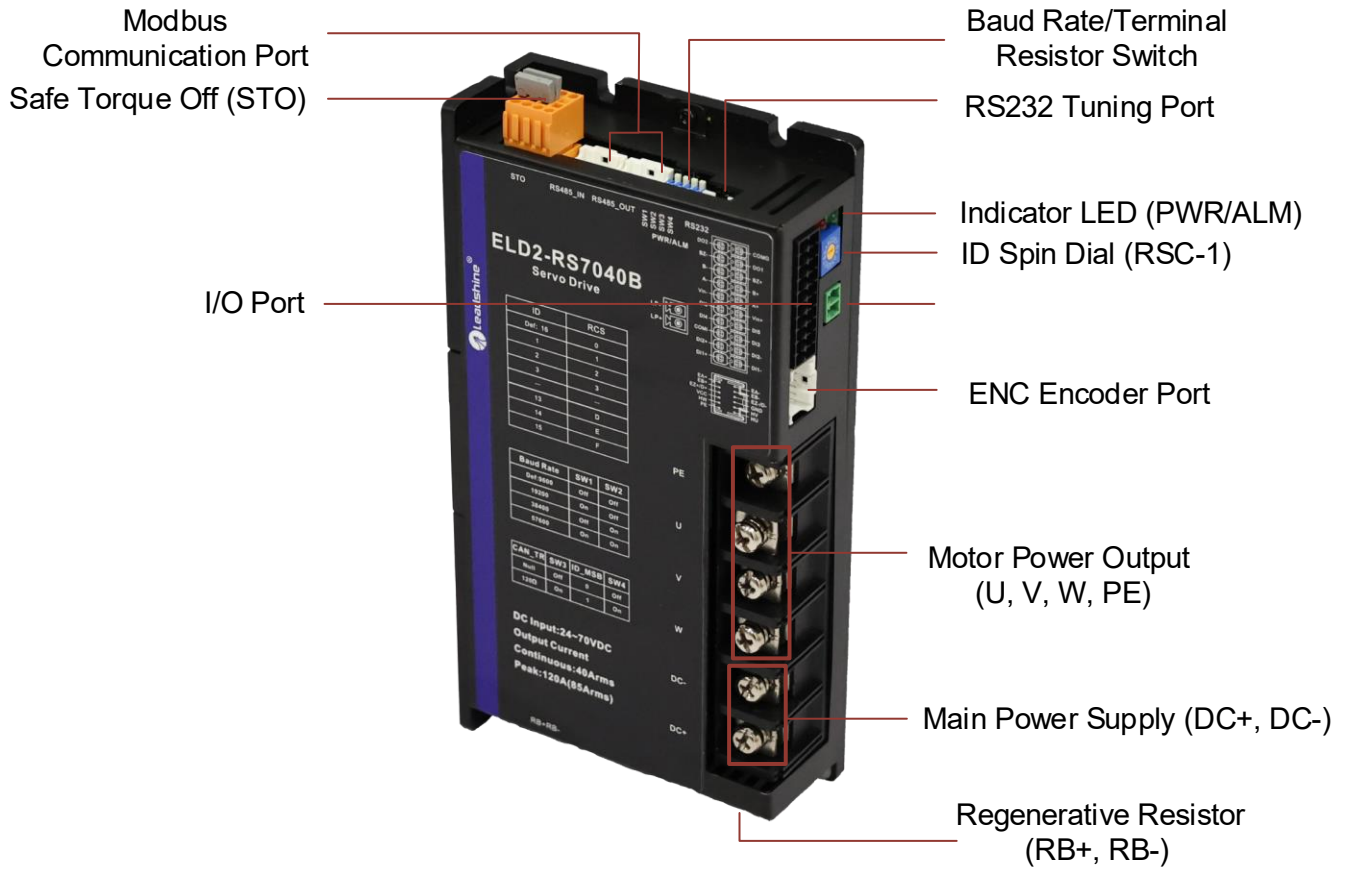
ELD2-RS Series Servo Drive (7040B/7060B)

1.5 Motor Ports and Connectors

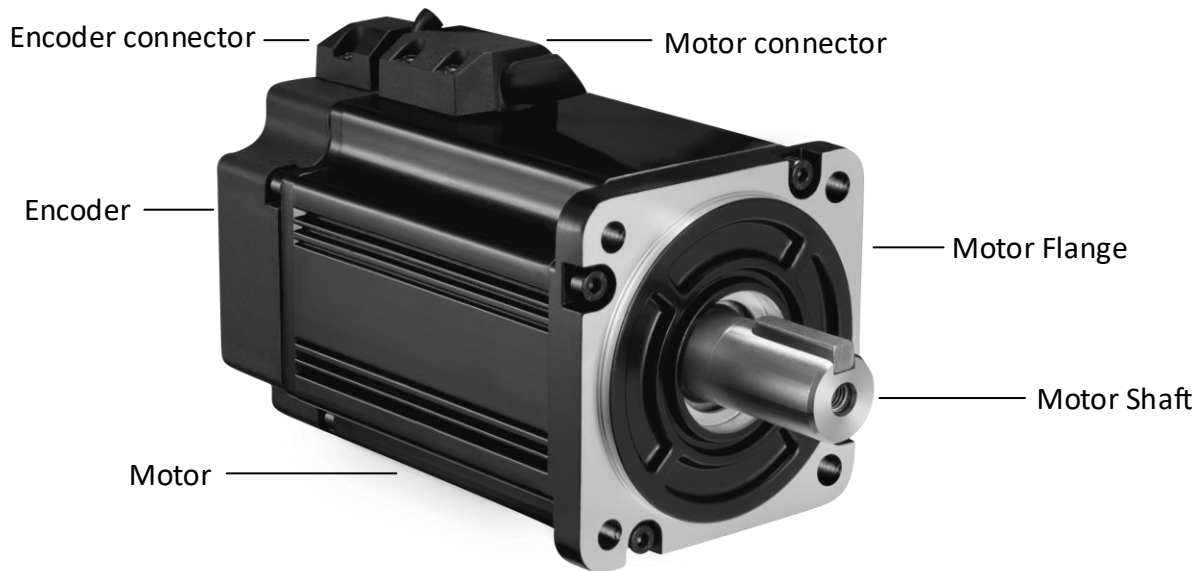
ELVM Series DC Servo Motor

Chapter 2 Installation & Wiring

2.1 Servo Drive Installation

2.1.1 Servo drive installation environment

Temperature	Storage: -20~+65°C (Condensation free); Installation: -20~+45°C (Please allow air circulation if >45°C)
Humidity	Under 90%RH (Condensation free)
Altitude	Up to 1000m above sea level
Atmospheric pressure	86 ~ 106kPa
Vibration	Less than 0.5G (4.9m/s ²) 10-55Hz (non-continuous working)
Atmospheric	No corrosive gas, combustibles, dirt or dust.
IP ratings	IP20

2.1.2 Servo drive dimension

Dimension 1: ELD2-RS7005/7010

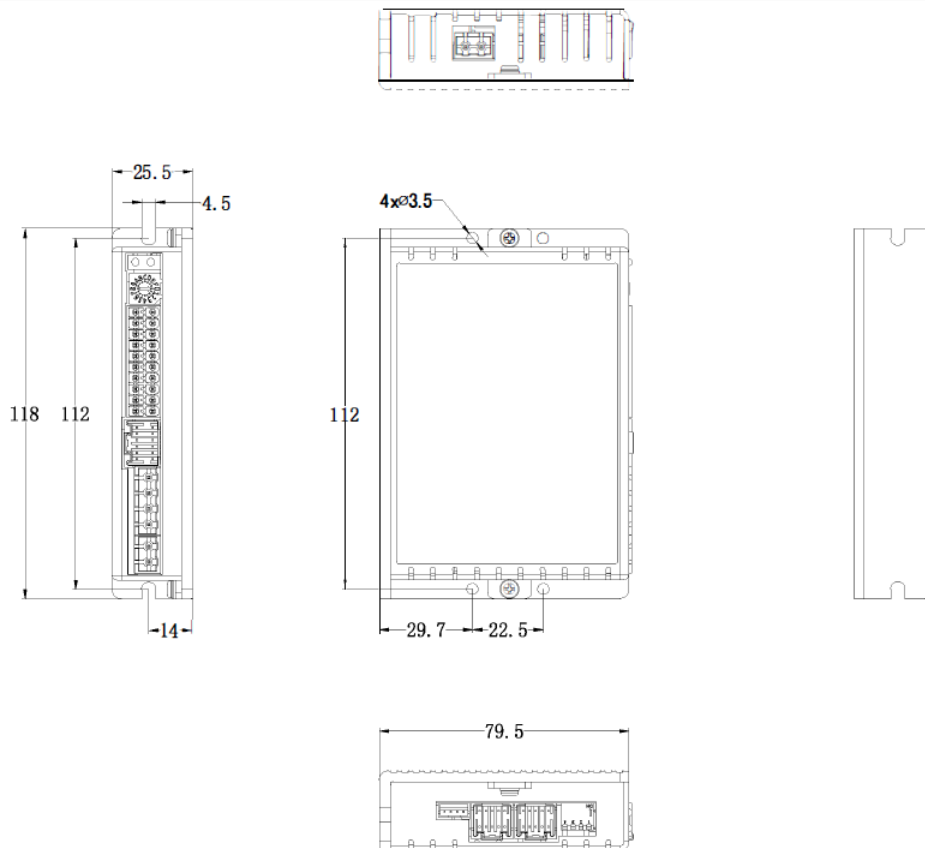

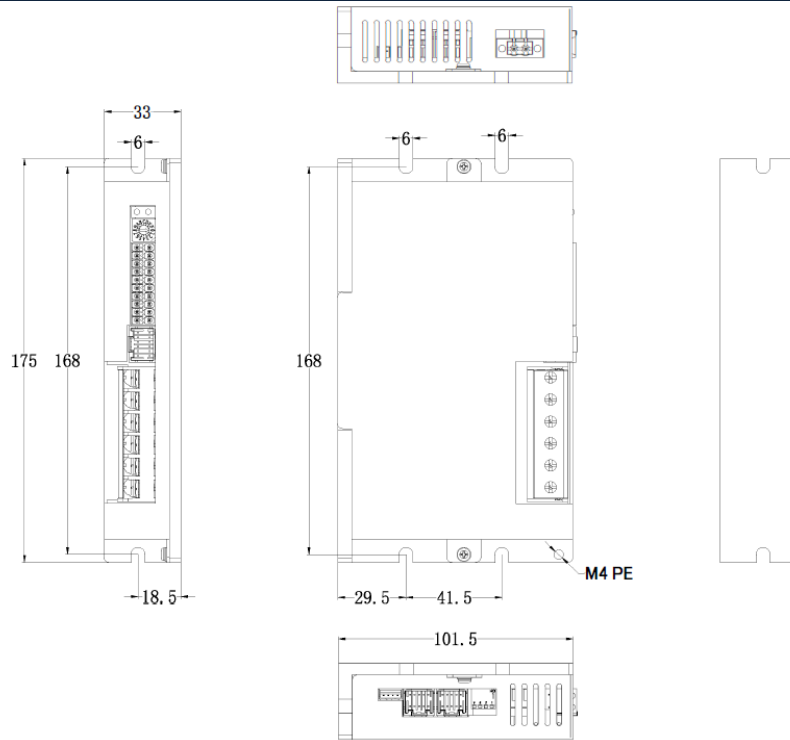
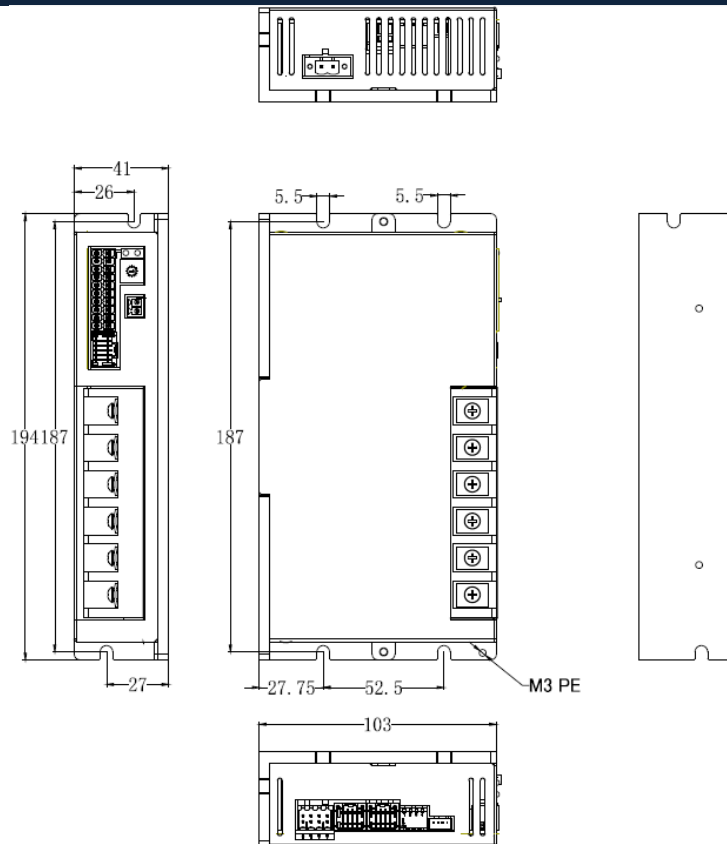
Dimension 2: ELD2-RS7015B/7020B/7030B

Dimension 3: ELD2-RS7040B/7060B

Space requirement for installation

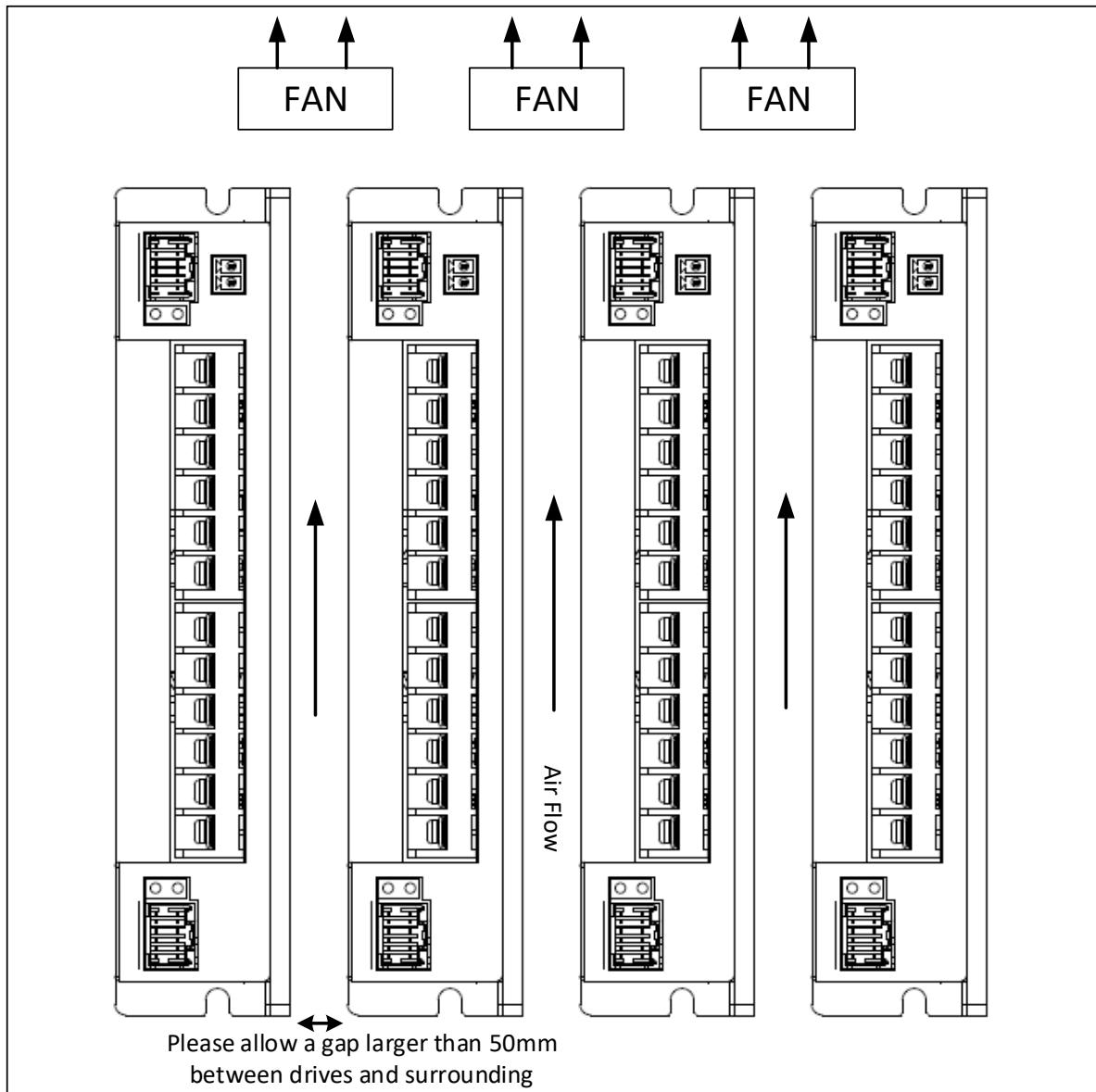
1. Please install the drive vertical to ground.
2. Please ensure optimal heat dissipation with enough room (>50mm) between each drives or to surrounding. It is recommended to install cooling fans for drives to achieve optimal performance.



Please refer to the diagram above for a visual guide on how to properly install the DC servo drives.

2.2 Servo Motor Installation

2.2.1 Installation conditions

Installation conditions may affect the lifespan of a motor

- Please keep away from corrosive fluid and combustibles.
- If dusty working environment is unavoidable, please use motors with oil seal.
- Please keep away from heat source.
- If motor is used in enclosed environment without heat dissipation, motor lifespan will be short.
- Please check and clean the installation spot before installation.

2.2.2 Precautions during installation

Installation method

Install horizontal to ground

Make sure power cable and encoder cable is facing downwards to make sure fluid doesn't leak into the ports.

Install vertical to ground

Please use a motor with oil seal when paired with a reducer to prevent reducer oil from leaking into the motor.

Oil- and waterproofing

- Do not submerge motor/cable under oil/water
- Please use a motor with oil seal when paired with a reducer to prevent reducer oil from leaking into the motor.
- If there is an unavoidable fluid leakage near the motor, please use motor with better IP ratings.
- Make sure power cable and encoder cable is facing downwards to make sure fluid doesn't leak into the ports.
- Avoid the usage of motor in water/oil leaking prone environment.

Cable under stress

- Do not the bend the cable especially at each ends of the connectors.
- Make sure to not let the cables be too tight and under tremendous stress especially thinner cables such as signal cables.

Connectors

- Please to remove any conductive foreign objects from the connectors before installation
- The connectors are made of resin. May not withstand impact.
- Please hold the driver during transportation, not the cables.
- Leave enough "bend" on the connector cables to ensure less stress upon installation.

Encoder & coupling

- During installation or removal of coupling, please do not hit the motor shaft with a hammer as it would cause damage to internal encoder.
- Please make sure to centralize the motor shaft and coupling, it might cause damage to motor or encoder due to vibration.
- Please make sure axial and radial load is within the limits specified as it might affect the lifespan of the motor or cause damage to it.

2.3 ELD2-RS Wiring Diagram

ELD2-RS Wiring Diagram

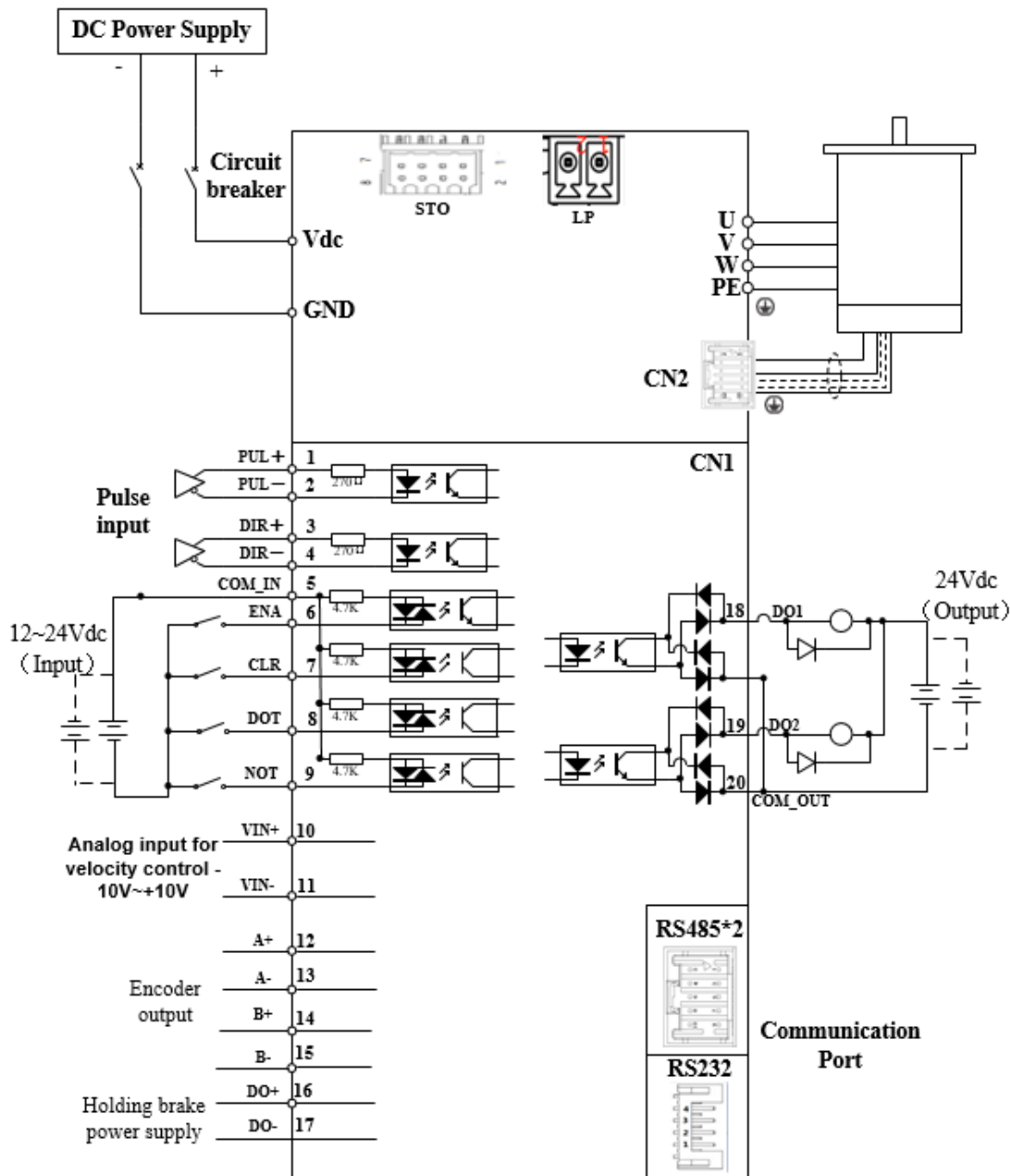

- Make sure data transferring cables are as short as possible. Keep CN1 cable under 3m and CN2 cable under 10m. Use shielded double winding cables to cut down on electromagnetic interference.
- If the load for DO is an inductive load such as a relay, please install freewheeling diodes on both ends of the load in parallel. Please keep in mind that if the diode is connected in reverse, it might cause damage to the drive.
- Use non-fuse breaker (NFB) to cut off power supply to the drive in case of emergency.

2.4 Servo Drive Ports

ELD2-RS 7005/7010/7015B/7020B/7030B

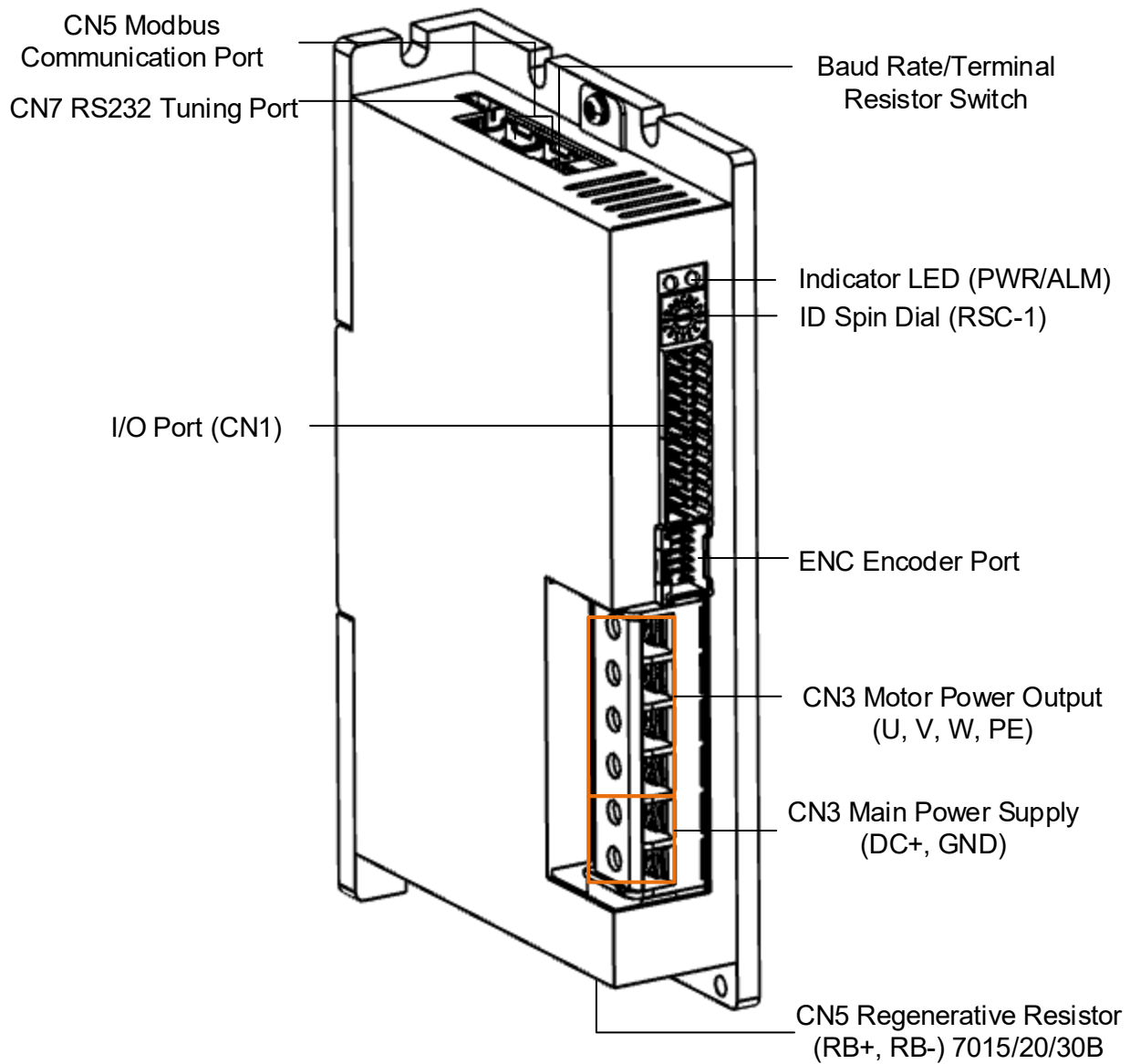

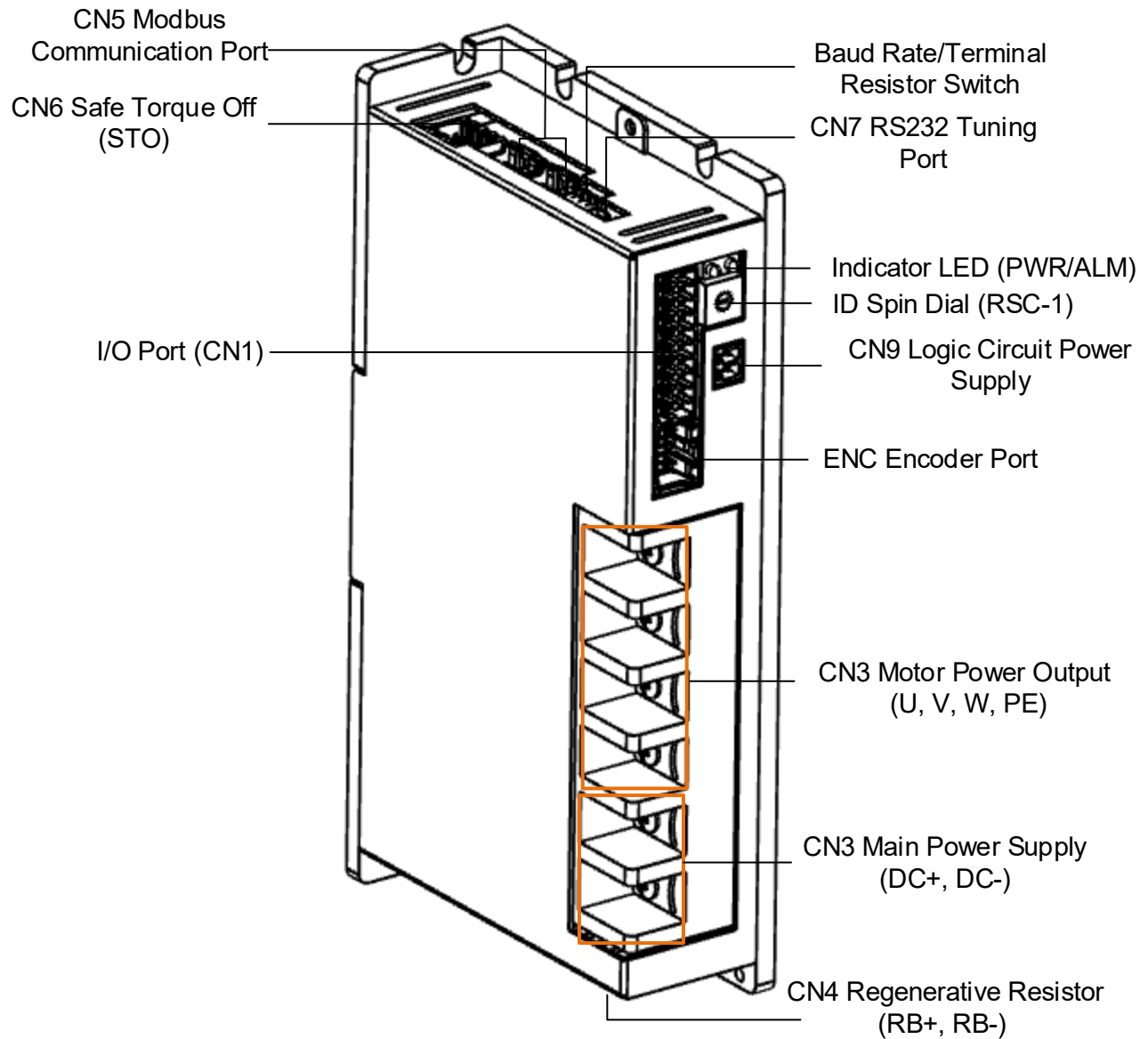
ELD2-RS 7040B/7060B

Connector	Label
CN1	I/O signal port
CN3	Motor power output (U, V, W, PE) Main Power Supply (DC+, DC-)
CN4	Regenerative resistor port (RB+, RB-)
CN5	Modbus Communication port
CN6	Safe Torque Off (STO) port
CN7	RS232 tuning port
CN9	Logic circuit power supply port
ENC	Motor encoder feedback
SW	Baud rate/Terminal resistor switch
RSC	ID spin dial

2.4.1 CN1 I/O Signal Port

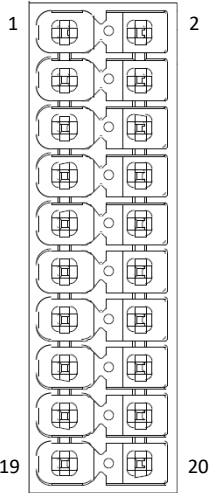
Diagram	CN	Pin	Signal	Description
	CN1	1	DI1+	Pulse input, differential, 500kHz
		2	DI1-	
		3	DI2+	Direction input, differential, 500kHz
		4	DI2-	
		5	COM_IN	Common DI
		6	D13	Servo enable
		7	D14	Alarm clear
		8	D15	Homing switch
		9	D16	Position limit
		10	A1+	Analog input, voltage -10~+10VDC, resistance 20kΩ
		11	A1-	
		12	A+	Encoder signal A output
		13	A-	
		14	B+	Encoder signal B output
		15	B-	
		16	BR+	Holding brake output positive and negative terminal, max current output: 1A
		17	BR-	
		18	DO1	Alarm output, current output <100mA
		19	DO2	Servo ready, current output <100mA
		20	COM_OUT	Common output

Pulse input

Pulse and direction input only support 5V signal. Please connect in series a resistor with resistance of $2k\Omega$ for 24V pulse and direction signal. Please refer to the following differential and single-ended input wiring diagrams.

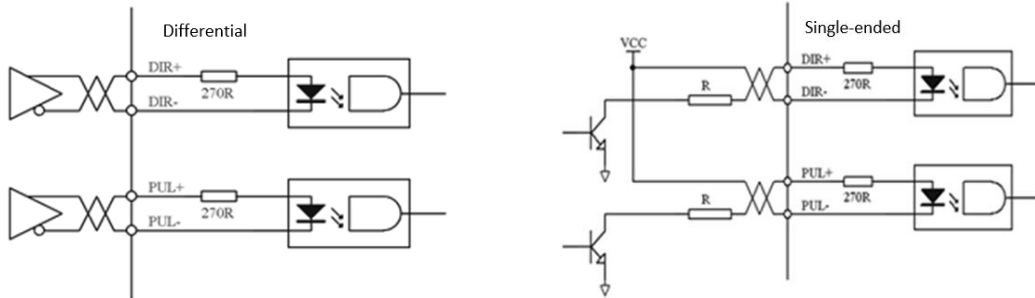

Following tables show pulse input signal and sequences. When a 2-phase input is used, 4 times of pulse frequency is $\leq 500\text{kHz}$.

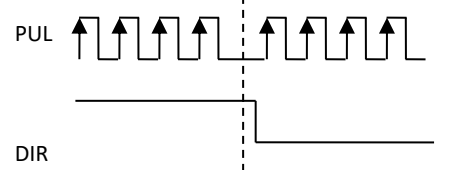
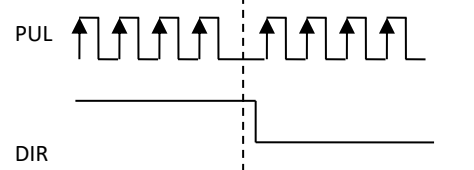
Pulse input mode	Counter clockwise	Clockwise	Settings
Pulse signal			Command pulse + direction

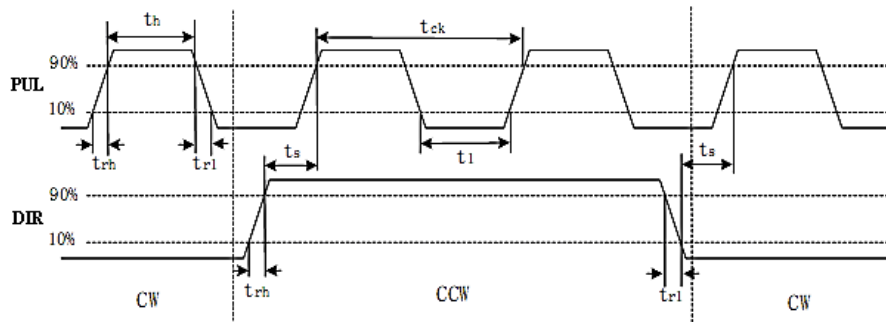

Symbol	Differential input	Single-ended input
t_{ck}	$> 2\mu\text{s}$	$> 5\mu\text{s}$
t_h	$> 1\mu\text{s}$	$> 2.5\mu\text{s}$
t_l	$> 1\mu\text{s}$	$> 2.5\mu\text{s}$
t_{rh}	$< 0.2\mu\text{s}$	$< 0.3\mu\text{s}$
t_{rl}	$< 0.2\mu\text{s}$	$< 0.3\mu\text{s}$
t_s	$> 1\mu\text{s}$	$> 2.5\mu\text{s}$
t_{qck}	$> 8\mu\text{s}$	$> 10\mu\text{s}$
t_{qh}	$> 4\mu\text{s}$	$> 5\mu\text{s}$

t_{q1}	$> 4\mu s$	$> 5\mu s$
t_{qrh}	$< 0.2\mu s$	$< 0.3\mu s$
t_{qrl}	$< 0.2\mu s$	$< 0.3\mu s$
t_{qs}	$> 1\mu s$	$> 2.5\mu s$

I/O Signal Wiring Diagram

1. DI3-DI6 supports NPN and PNP configuration. Recommended to use an external control signal power supply of 12-24VDC.

2. DO1-DO2 are single ended outputs with 100mA current output that supports NPN and PNP configuration. Recommended to use an external power supply of 24VDC. If the load is an inductive load such as a relay, please install freewheeling diodes on both ends of the load in parallel. If the diode is connected in reverse, it might cause damage to the driver.

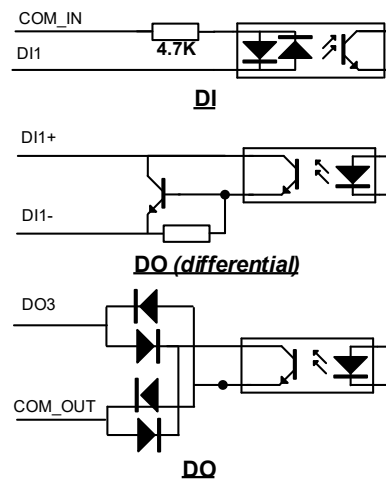

CN1 control signal cable selection

To ensure I/O signal to not be affected by electromagnetic interference, a **shielded cable** is recommended for this application.

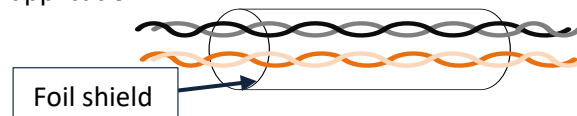

Cables for different analogue signals should be using isolated shielded cable while cables for digital signals should be shielded twisted pair cable. Cables for CN1 connectors should be 24-28AWG in diameter.

2.4.2 CN3/CN4 Power supply & Regenerative Resistor Port

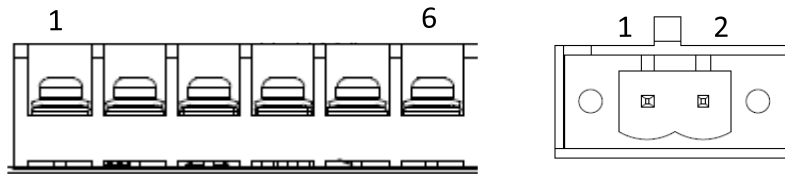

CN3			CN4	
Port	Pin	Signal	Description	
CN3	1	DC+	DC Power Supply positive and negative terminals	
	2	DC-		
	3	PE	U, V, W, PE terminals for motor	
	4	U		
	5	V		
	6	W		
CN4	1	DC+	DC Power Supply positive and negative terminals	
	2	DC-		

2.4.3 CN5 Modbus RS485 Communication Port

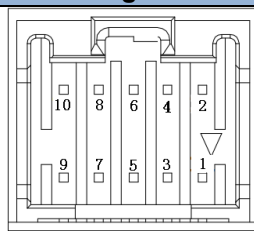
Port	Diagram	Pin	Signal	Label
CN5		1	RS485+	Modbus positive terminal
		3	RS485+	Modbus negative terminal
		5	GND	Power supply ground
		Others	NC	10 pins are not applicable

Note:

- Molex 55959-1030 Connector Header (Driver side)
- Molex 51353-1000 10-pin rectangle connector 1pcs for each axis (Provided)
- Molex 56134-9000 female terminal reel 10pcs for each axis (Provided)

2.4.4 CN6 Safe Torque Off (STO) Port

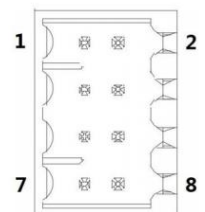
Port	Diagram	Pin	Signal	Description	Remarks
CN6		1	5V	24v power supply	Connect to SF1 and SF2 when not in use. Do not use to supply power.
		2	GND	Reference ground	
		3	STO1+	STO 1 positive input	When SF1 = OFF or SF2 = OFF, STO is enabled.
		4	STO1-	STO 1 negative input	
		5	STO2+	STO 2 positive input	
		6	STO2-	STO 2 negative input	
		7	EDM+	External monitoring device (EDM) with differential double	When SF1 = OFF and SF2 = OFF, EDM = ON
		8	EDM-		

Introduction to Safe Torque Off (STO)

Function: Cut off motor current supply physically (through mechanical means)

STO module (CN6 connector) consists of 2 input channels. It cuts off the motor current supply by blocking of PWM control signal from the power module. When the motor current is cut off, the motor will still move under inertia and stops gradually.

The STO function is set up ready to be used by factory default. Please remove STO connector if it is not needed.

STO functional principle

STO module cuts off the motor current supply and stops motor gradually by blocking of PWM control signal from the power module through 2 isolated circuits. When a STO error occurs, the actual status of STO can be determined by the EDM status feedback.

STO1 Input Status	STO2 Input Status	EDM Output Status	PWM control signal	Alarm code
ON	ON	OFF	Normal	-
ON	OFF	OFF	Blocked	Er 1c2
OFF	ON	OFF	Blocked	Er 1c1
OFF	OFF	ON	Blocked	Er 1c0

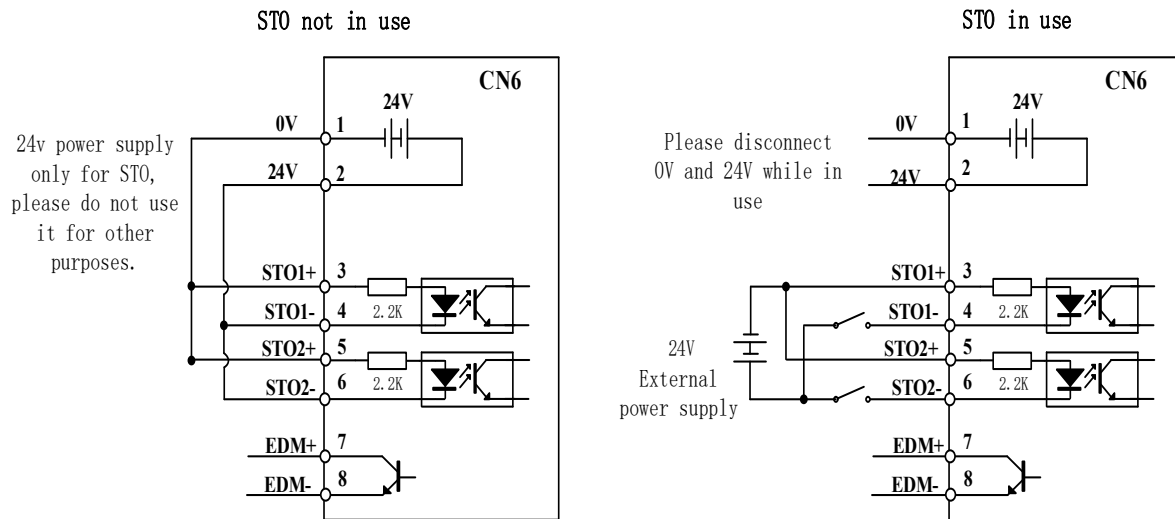
STO wiring diagram

- Please take precautions when enabling STO functions as servo drive will lose control over the motion of the motor. Motor might dropped under gravitational pull (vertically mounted load) or moved when external forces are applied to it. Alternatively, motor with holding brake can be chosen.
- STO is not meant to cut off the power supply of the servo drivers and motors completely. Please power off and wait for a few minutes before starting maintenance work.
- It is recommended to use an isolated power supply for STO signal input as any current leakage might cause STO malfunction.

2.4.5 CN7 RS232 Tuning Port

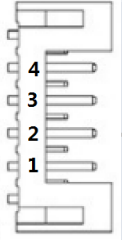
Port	Diagram	Pin	Signal
CN7		1	5V
		2	TX
		3	GND
		4	RX

ELD2-RS Series DC Servo Drive can be connected to Motion Studio for parameters tuning and data monitoring using **CABLE-PC-1**.

2.4.6 CN9 Logic Circuit Power Supply Port

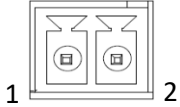
Port	Diagram	Pin	Signal	Description
CN9		1	24V	24V positive terminal
		2	GND	24V negative terminal

ELD2-RS7040B/7060B dual-axis DC servo drives include an optional logic circuit power supply port.

When main power supply is cut, logic circuit power supply port can be connected to realize:

1. Partially functional DSP
2. Holding brake output to directly control the status of motor holding brake

2.4.7 ENC Encoder Feedback Port

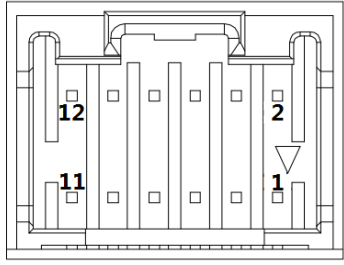
Port	Diagram	Pin	Signal	Description
ENC		1	Foil Shield	Encoder cable shielded layer
		2	HU	Motor Hall U signal
		3	HW	Motor Hall W signal
		4	HV	Motor Hall V signal
		5	VCC	5V power supply from driver. Only for encoder
		6	GND	
		7	EZ+/D+	Encoder Z phase positive signal / encoder positive terminal
		8	EZ-/D-	Encoder Z phase negative signal / encoder negative terminal
		9	EB+	Encoder B phase positive signal
		10	EB-	Encoder B phase negative signal
		11	EA+	Encoder A phase positive signal
		12	EA-	Encoder B phase negative signal

For motors with 17-bit magnetic encoder (battery kit connected externally for absolute encoder):

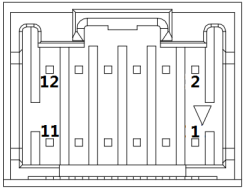
Port	Diagram	Pin	Signal	Description
ENC		1	Frame	Protective earth
		5	VCC5V	Power Supply 5V
		6	GND	Power Supply Ground
		7	SD+	SSI Data+
		8	SD-	SSI Data-

Note:

- Molex 55959-1230 Connector Header (Driver side)
- Molex 51353-1200 12-pin rectangle connector 1pcs for each axis (Provided)
- Molex 56134-9000 female terminal reel 12pcs for each axis (Provided)

2.4.8 ID spin dial RSC

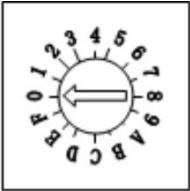
	Diagram	Bit	Modbus address	Bit	Modbus address
RCS		0	Pr5.31 Default : 16	8	8
		1	1	9	9
		2	2	A	10
		3	3	B	11
		4	4	C	12
		5	5	D	13
		6	6	E	14
		7	7	F	15

2.4.9 Baud rate/Terminal resistor switch SW

Diagram	Function		Pr6.33	SW4	Baud rate	SW1	SW2	Terminal resistor	SW3
	Motor direction	CCW (Default)	0	OFF	Pr5.30 Default: 9600	OFF	OFF	Disconnected	OFF
		CW		ON	19200	ON	OFF		
	Modbus high bit address	Spin dial	8	OFF	38400	OFF	ON	Connected	ON
		16+Spin dial		ON	57600	ON	ON		

2.5 Cable Selection

2.5.1 Motor Power Cable

Motor winding power cable

- Wire length available: 0.5m, 1.5m, 3m, 5m, 7m and 10m.
- Connectors type available: SP21 connector
- Please contact Leadshine sales team or any Leadshine certified local retailers for any customized needs.

**M*: Length of the cable*

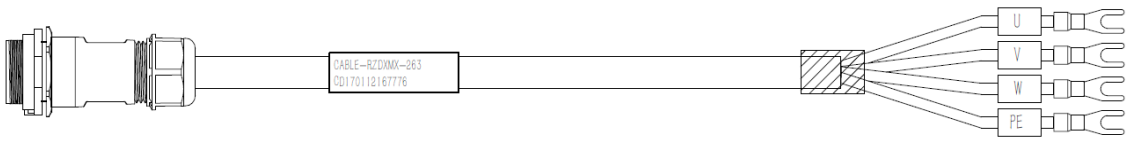
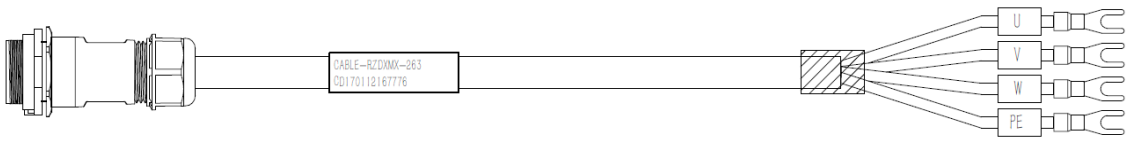
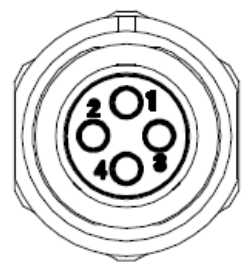
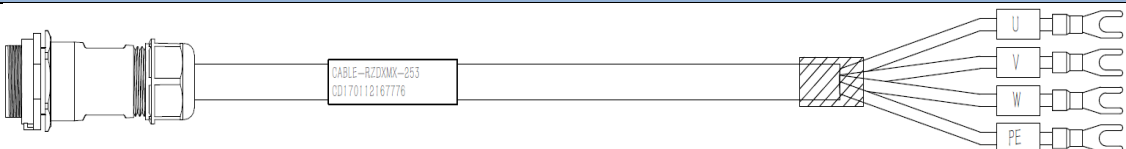
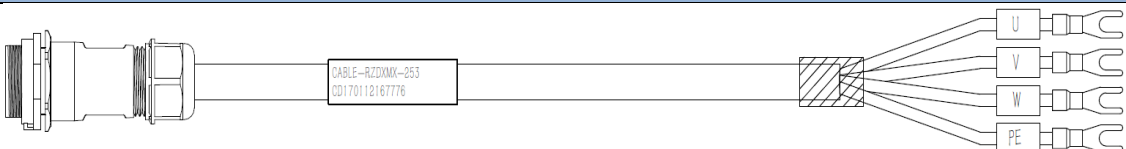
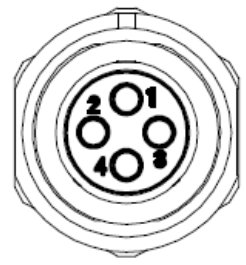
Motor Power Cable CABLE-RZD*M*-263 12AWG																
																
Motor side	Driver side															
Driver cable pin	Pins															
	<table border="1"> <thead> <tr> <th>Motor</th> <th>Color</th> <th>Driver</th> </tr> </thead> <tbody> <tr> <td>1</td> <td>Blue</td> <td>U</td> </tr> <tr> <td>2</td> <td>White</td> <td>V</td> </tr> <tr> <td>3</td> <td>Black</td> <td>W</td> </tr> <tr> <td>4</td> <td>Yellow- green</td> <td>PE</td> </tr> </tbody> </table>	Motor	Color	Driver	1	Blue	U	2	White	V	3	Black	W	4	Yellow- green	PE
Motor	Color	Driver														
1	Blue	U														
2	White	V														
3	Black	W														
4	Yellow- green	PE														
Motor Power Cable CABLE-RZD*M*-253 14AWG																
																
Motor side	Driver side															
Driver cable pin	Pins															
	<table border="1"> <thead> <tr> <th>Motor</th> <th>Color</th> <th>Driver</th> </tr> </thead> <tbody> <tr> <td>1</td> <td>Red</td> <td>U</td> </tr> <tr> <td>2</td> <td>White</td> <td>V</td> </tr> <tr> <td>3</td> <td>Black</td> <td>W</td> </tr> <tr> <td>4</td> <td>Yellow- green</td> <td>PE</td> </tr> </tbody> </table>	Motor	Color	Driver	1	Red	U	2	White	V	3	Black	W	4	Yellow- green	PE
Motor	Color	Driver														
1	Red	U														
2	White	V														
3	Black	W														
4	Yellow- green	PE														

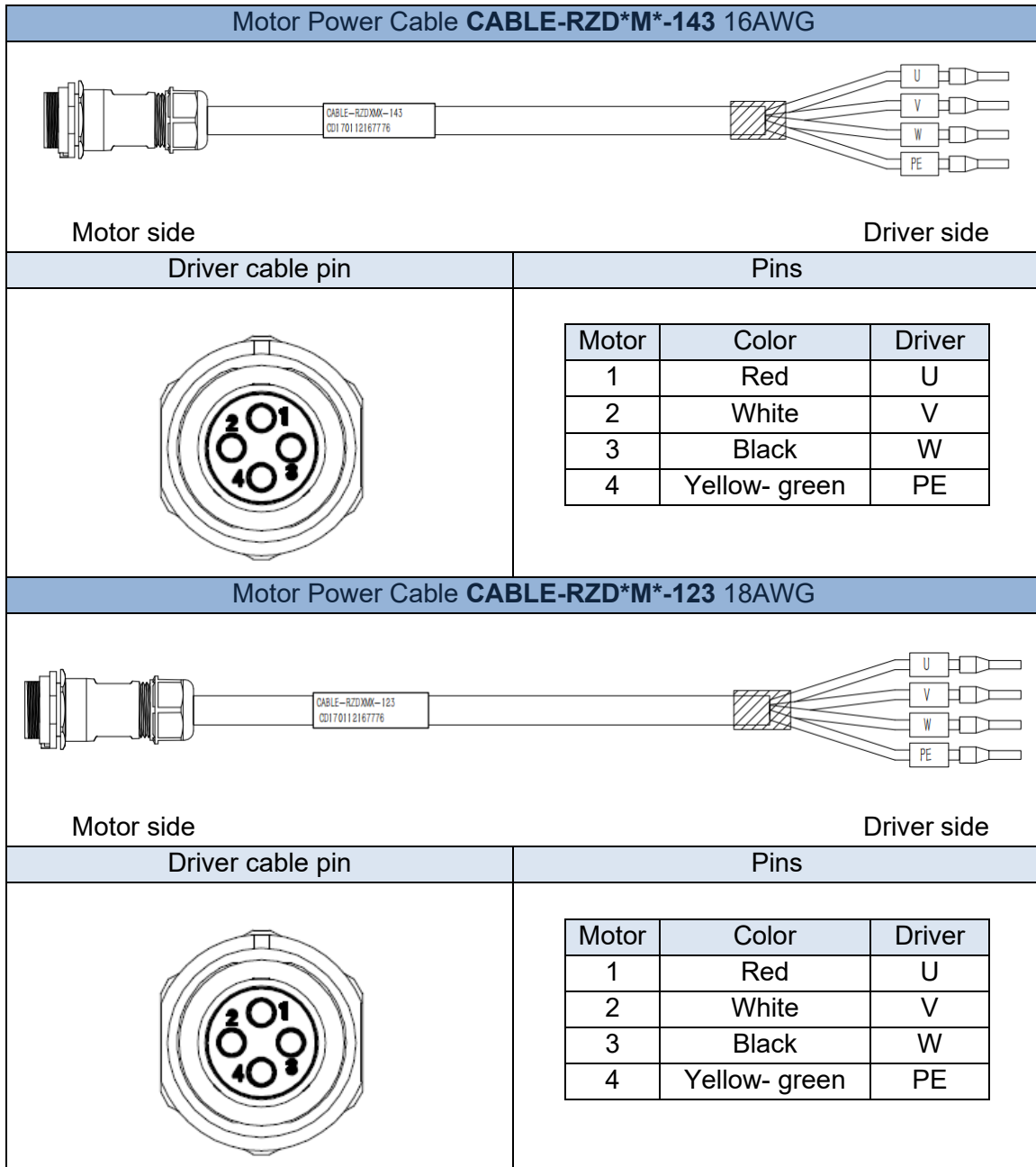

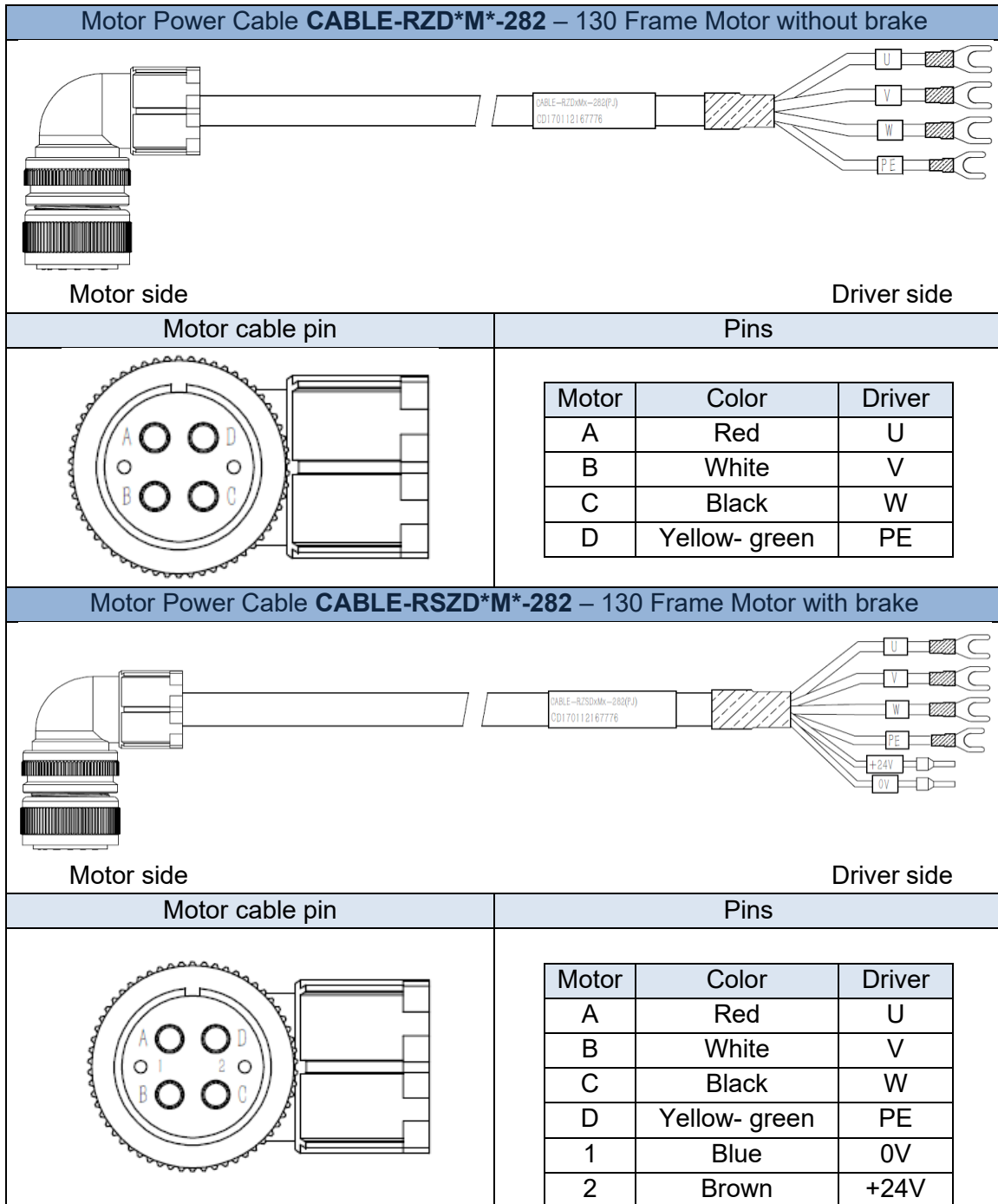

Recommended wire diameter for each drive

Drive	Wiring diameter (mm ² /AWG)		
	DC+, DC-	UVW	PE
ELD2-RS7005B	AWG18	AWG18	AWG18
ELD2-RS7010B	AWG16	AWG16	AWG16
ELD2-RS7015B	AWG14	AWG16	AWG16
ELD2-RS7020B	AWG12	AWG12	AWG12
ELD2-RS7030B	AWG10	AWG10	AWG10
ELD2-RS7040B	AWG8	AWG8	AWG8
ELD2-RS7060B	AWG6	AWG6	AWG6

- **Grounding:** Grounding wire should be thicker. Ground PE terminal of servo drive and servo motor together with resistance <math>< 100 \Omega</math>.
- Connect a line filter to power supply to reduce electromagnetic interference.
- Please install a fuseless circuit breaker to cut off power supply in time when the driver fails.

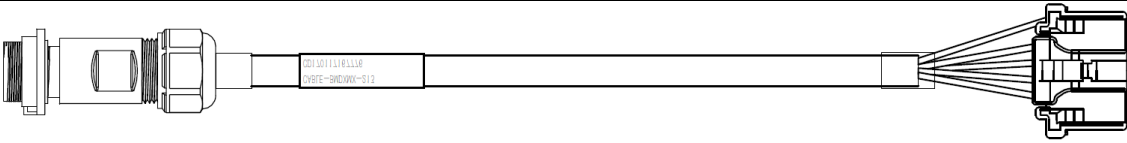
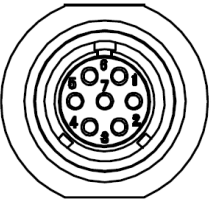
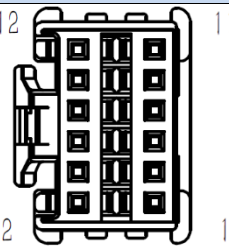
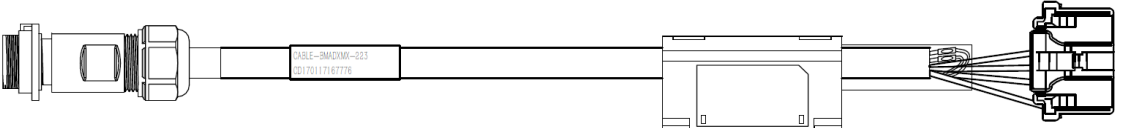
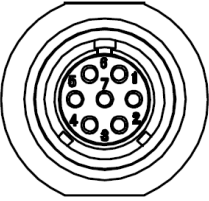
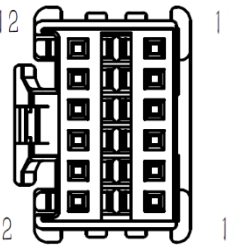
2.5.2 Motor Encoder Cable

CABLE-BMD*M*-213 for single turn encoder																																				
		<div style="display: flex; justify-content: space-between; width: 100%;"> Motor side Driver side </div>																																		
Motor cable pin		Pin																																		
 <p>Motor side</p>	 <p>Driver side</p>	<table border="1" style="width: 100%; border-collapse: collapse;"> <thead> <tr style="background-color: #d9e1f2;"> <th>Color</th> <th>Signal</th> <th>Motor</th> <th>Drive</th> </tr> </thead> <tbody> <tr> <td>Braid</td> <td>Shield</td> <td>1</td> <td>1</td> </tr> <tr> <td>Red</td> <td>+5V</td> <td>2</td> <td>5</td> </tr> <tr> <td>Red-white</td> <td>GND</td> <td>3</td> <td>6</td> </tr> <tr> <td>Blue</td> <td>SD+</td> <td>4</td> <td>7</td> </tr> <tr> <td>Blue-Black</td> <td>SD-</td> <td>5</td> <td>8</td> </tr> </tbody> </table>	Color	Signal	Motor	Drive	Braid	Shield	1	1	Red	+5V	2	5	Red-white	GND	3	6	Blue	SD+	4	7	Blue-Black	SD-	5	8										
Color	Signal	Motor	Drive																																	
Braid	Shield	1	1																																	
Red	+5V	2	5																																	
Red-white	GND	3	6																																	
Blue	SD+	4	7																																	
Blue-Black	SD-	5	8																																	
CABLE-BMAD*M*-223 with battery kit for multiturn absolute encoder																																				
		<div style="display: flex; justify-content: space-between; width: 100%;"> Motor side Driver side </div>																																		
Motor cable pin		Pin																																		
 <p>Motor side</p>	 <p>Driver side</p>	<table border="1" style="width: 100%; border-collapse: collapse;"> <thead> <tr style="background-color: #d9e1f2;"> <th>Color</th> <th>Signal</th> <th>Motor</th> <th>Drive</th> </tr> </thead> <tbody> <tr> <td>Braid</td> <td>Shield</td> <td>1</td> <td>1</td> </tr> <tr> <td>Black</td> <td>+5V</td> <td>2</td> <td>5</td> </tr> <tr> <td>Black-White</td> <td>GND</td> <td>3</td> <td>6</td> </tr> <tr> <td>Blue</td> <td>SD+</td> <td>4</td> <td>7</td> </tr> <tr> <td>Blue-Black</td> <td>SD-</td> <td>5</td> <td>8</td> </tr> <tr> <td>Red</td> <td>BAT+</td> <td>6</td> <td>-</td> </tr> <tr> <td>Red-White</td> <td>BAT-</td> <td>7</td> <td>-</td> </tr> </tbody> </table>	Color	Signal	Motor	Drive	Braid	Shield	1	1	Black	+5V	2	5	Black-White	GND	3	6	Blue	SD+	4	7	Blue-Black	SD-	5	8	Red	BAT+	6	-	Red-White	BAT-	7	-		
Color	Signal	Motor	Drive																																	
Braid	Shield	1	1																																	
Black	+5V	2	5																																	
Black-White	GND	3	6																																	
Blue	SD+	4	7																																	
Blue-Black	SD-	5	8																																	
Red	BAT+	6	-																																	
Red-White	BAT-	7	-																																	

For ELVM series motors with 130 flange size

CABLE-BMD*M*-212 for single turn encoder

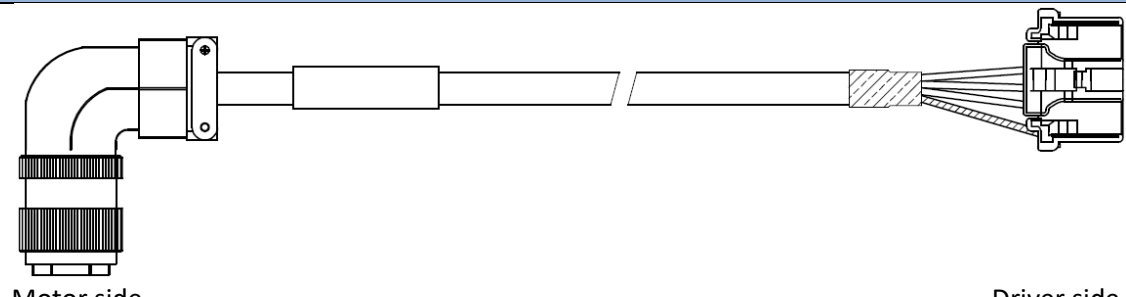

Motor side Driver side

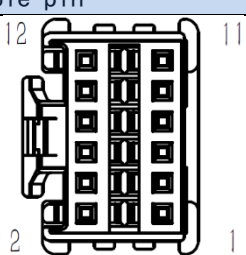
Motor cable pin		Pin			
 Motor side	 Driver side	Color	Signal	Motor	Drive
		Braid	Shield	1	1
		Red	+5V	2	5
		Red- white	GND	3	6
		Blue	SD+	4	7
		Blue- Black	SD-	5	8

CABLE-BMAD*M*-222 with battery kit for multiturn absolute encoder

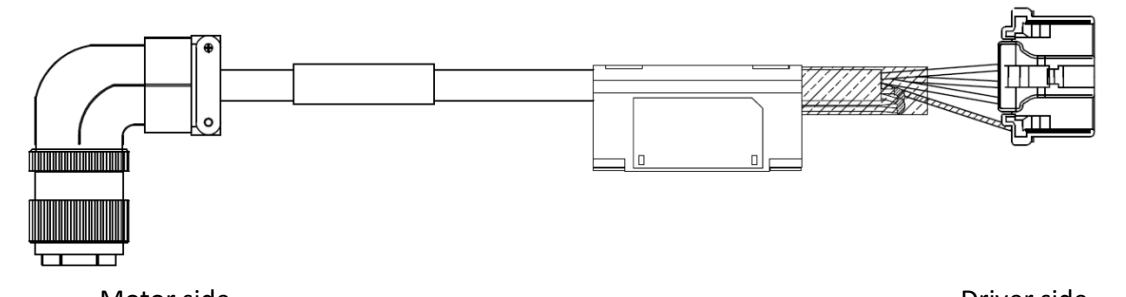

Motor side Driver side

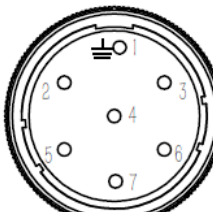
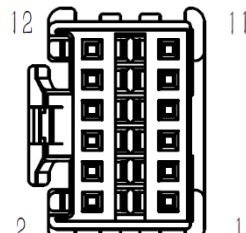
Motor cable pin		Pin			
 Motor side	 Driver side	Color	Signal	Motor	Drive
		Braid	Shield	1	1
		Black	+5V	2	5
		Black- White	GND	3	6
		Blue	SD+	4	7
		Blue- Black	SD-	5	8
		Red	BAT+	6	-
		Red- White	BAT-	7	-

2.5.3 Motor Brake Cable

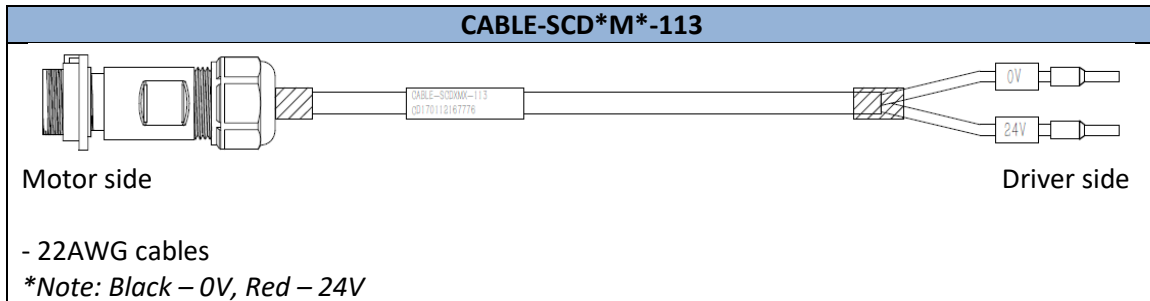

2.5.4 Drive Communication Cable

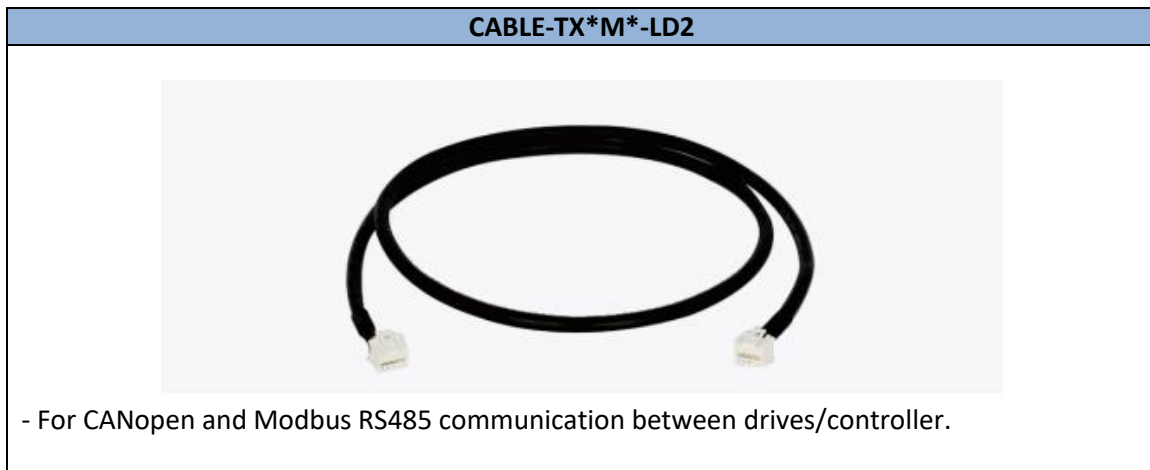

2.5.4 Tuning Cable

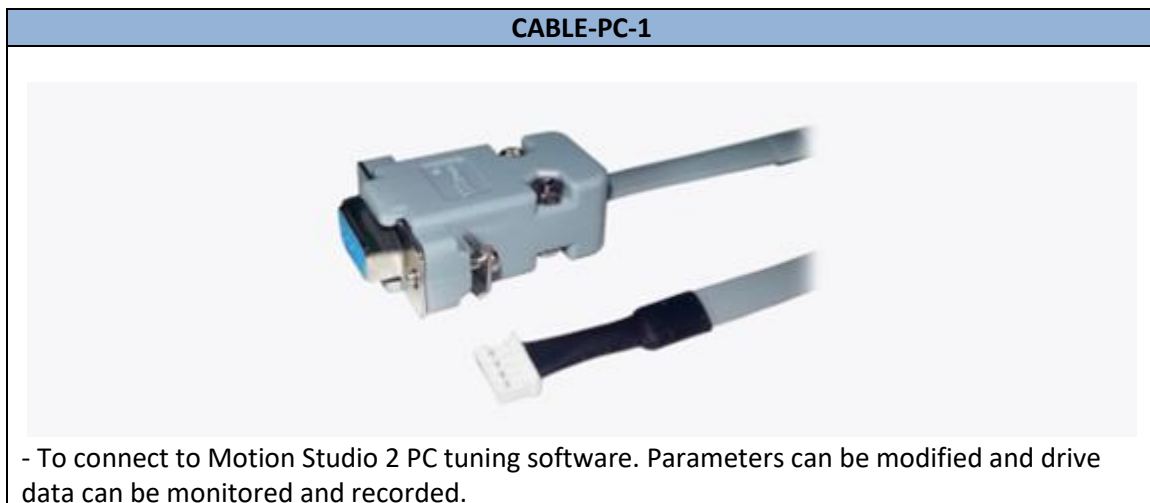

2.6 Regenerative Resistor Selection

The use of regenerative resistor

When the motor opposes the direction of rotation as in deceleration or vertical axis escalation, part of the regenerative energy will be delivered back to the driver. This energy will first be stored in internal capacitors of the driver. When the energy stored in the capacitors reach the maximum capacity, a regenerative resistor is required the excessive energy to prevent over-voltage.

Calculation of regenerative resistance under normal operation

Steps:

1. Determine if driver comes with a regenerative resistor. If not, please prepare a regenerative resistor with resistance value higher than might be required.
2. Monitor the load rate of the regenerative resistor using front panel (d14). Set the driver on high velocity back and forth motions with high acceleration/deceleration.
3. Please make sure to obtain the value under following conditions: Driver temperature < 60°C, d14<80(Won't trigger alarm), Regenerative resistor is not fuming, No overvoltage alarm(Err120).

$$P_b(\text{Regenerative power rating}) = \text{Resistor power rating} \times \text{Regenerative load rate (\%)}$$

Please choose a regenerative resistor with power rating P_r about **2-4 times the value of P_b** in considered of harsh working conditions and some 'headroom'.

If the calculated P_r value is less than internal resistor power rating, external resistor is not required.

$$R(\text{Max. required regenerative resistance}) = (380^2 - 370^2)/P_r$$

Problem diagnostics related to regenerative resistor:

- If driver temperature is high, reduce regenerative energy power rating or use an external regenerative resistor.
- If regenerative resistor is fuming, reduce regenerative energy power rating or use an external regenerative resistor with higher power rating.
- If d14 is overly large or increasing too fast, reduce regenerative energy power rating or use an external regenerative resistor with higher power rating.
- If driver overvoltage alarm (Er120) occurs, please use an external regenerative resistor with lower resistance or connect another resistor in parallel.

Please take following precautions before installing an external regenerative resistor.

1. Please set the correct resistance value in Pr0.16 and resistor power rating Pr0.17 for the external regenerative resistor.
2. Please ensure the resistance value is higher or equals to the recommended values in table 2-3. Regenerative resistors are generally connected in series but they can also be connected in parallel to lower the total resistance.
3. Please provided enough cooling for the regenerative resistor as it can reach above 100°C under continuous working conditions.
4. The min. resistance of the regenerative resistor is dependent on the IGBT of the regenerative resistor circuit. Please refer to the table above.

Theoretical selection of regenerative resistor

Without external loading torque, the need for an external regenerative resistor can be determined as the flow chart below

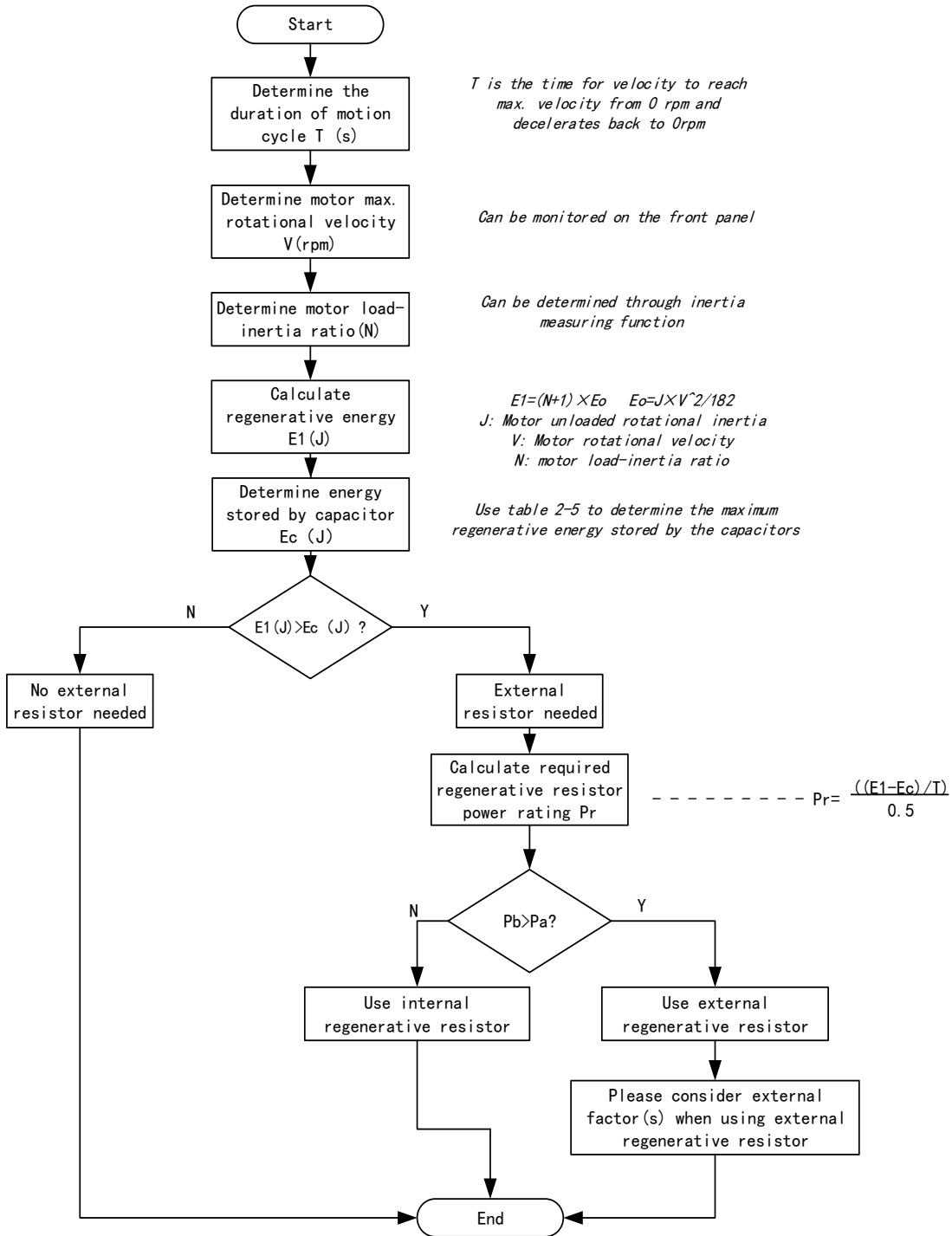
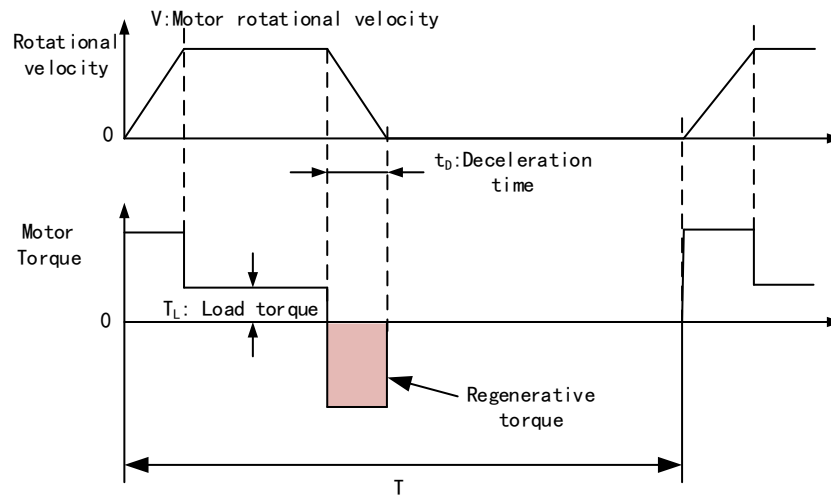

Diagram below shows the acceleration and deceleration cycle periods and the regenerative torque that occurs during the process.



Steps to calculate capacity of regenerative resistor

Steps	Calculation	Symbol	Formula
1	Servo system regenerative energy	E ₁	$E_1 = (N+1) \times J \times V^2 / 182$
2	Depleted energy from loss of load system during acceleration	E _L	$E_L = (\pi/60) V \times T_L \times t_D$ <i>If loss is not determined, please assume E_L = 0.</i>
3	Depleted energy due to motor coil resistance.	E _M	$E_M = (U^2/R) \times t_D$ R= coil resistance, U = operating voltage <i>If R is not determined, please assume E_M = 0.</i>
4	Energy stored by internal DC capacitors	E _C	Please refer to table 2-5
5	Depleted energy due to regenerative resistance	E _K	$E_K = E_1 - (E_L + E_M + E_C)$, <i>If loss is ignored, E_K = E₁ - E_C</i>
6	Required power rating of regenerative resistor	P _r	$P_r = E_K / (0.5 \times T)$

Note:

- 0.5 in the calculation for P_r represent 50% load rate of regenerative resistor.
- E₁-E_K: Energy(Joule) T_L: Load torque(Nm) V: Motor velocity(rpm/min)
P_r: Regenerative resistor power rating t_D: Deceleration stop time(s)
J: Rotor inertia (kgm²) T: Motor cycle time(s) N: Ratio of load inertia and rotor inertia

Internal capacitor capacity and rotor inertia

ELD2 Drives	Servo motor	Rotor Inertia ($\times 10^{-4}\text{kg}\cdot\text{m}^2$)	Max. regenerative energy stored in capacitor $E_c(\text{J})$
750W (7020B)	ELVM8075V48FH-M17	1.5	2.26
1000W (7030B)	ELVM80100V48FH-M17	1.79	2.26

There are motors with low, medium and high inertia. Different motor models have different rotor inertia. Please refer to product catalogue for more information on rotor inertia. Please cut down 30%-40% of load rate if the product is used in harsh environment with less than ideal heat dissipation measures.

Recommended regenerative resistor specification for each drives

Drives	Resistance (Ω)	Power rating(W)	Min. Resistance(Ω)
ELD2-RS7005B	10	30	5
ELD2-RS7010B	10	50	5
ELD2-RS7015B	10	50	5
ELD2-RS7020B	10	100	5
ELD2-RS7030B	10	100/150	5
ELD2-RS7040B	10	150/200	5
ELD2-RS7060B	10	150/200	5

Note:

1. Use 10 Ω /100W resistor for test operation and make sure: Drive temperature $d33 < 60^\circ\text{C}$, dynamic brake is not in alarm mode (Braking rate $d14 < 80$), brake resistor is not overheated, drive has no overcurrent alarm.
2. If drive temperature is too high, increase power rating of regenerative resistor or reduce drive power.
3. If brake resistor is overheated, reduce drive power or use regenerative resistor with higher resistance.
4. If $d14$ is too high, reduce drive power or use regenerative resistor with higher resistance and power ratings.
5. External torque might cause regenerative energy to flow back into drive. During normal operation, torque output in the same direction as rotational direction but if external torque exists, directions might oppose and in this case, regenerative resistor with higher resistance may be required.

Chapter 3 Parameter

3.1 Parameters list

Classification code Pr0.00 Sub-code

Valid mode:

P: Valid in position control mode

S: Valid in velocity control mode

T: Valid in torque control mode

PR: Valid in PR control mode

Activation:

“O” – Restart driver for parameter changes to be valid

“—” – Valid immediately

“Δ” – Valid when axis stops

“●”- Valid after re-enabling

[Class 0] Basic settings

Code	Label	Default	Activ ation	Valid mode			Communication mode		
				P	S	T	Byte	Op.	485 Addr.
Pr0.00	Model-following bandwidth	1	Δ	O	—	—	16bit	R/W	0x0001
Pr0.01	Control Mode Settings	0	O	O	O	O	16bit	R/W	0x0003
Pr0.02	Real time Auto Gain Adjusting	0x1	—	O	O	O	16bit	R/W	0x0005
Pr0.03	Real time auto stiffness adjusting	70	—	O	O	O	16bit	R/W	0x0007
Pr0.04	Inertia ratio	250	—	O	O	O	16bit	R/W	0x0009
Pr0.05	Command pulse input selection	0	O	O	—	—	16bit	R/W	0x000B
Pr0.06	Command pulse polarity inversion	0	O	O	—	—	16bit	R/W	0x000D
Pr0.07	Command pulse input mode	3	O	O	—	—	16bit	R/W	0x000F
Pr0.08	1 st command pulse count per revolution	10000	O	O	—	—	32bit	R/W	0x0010 0x0011
Pr0.09	1 st command frequency divider/multiplier numerator	1	O	O	—	—	32bit	R/W	0x0012 0x0013
Pr0.10	1 st command frequency divider/multiplier denominator	1	O	O	—	—	32bit	R/W	0x0014 0x0015
Pr0.13	1 st Torque Limit	350	—	O	O	O	16bit	R/W	0x001B
Pr0.14	Excessive position deviation	30	—	O	—	—	16bit	R/W	0x001D
Pr0.15	Absolute Encoder settings	0	O	O	O	O	16bit	R/W	0x001F
Pr0.16	Regenerative resistance	100	—	O	O	O	16bit	R/W	0x0021

Code	Label	Default	Activ ation	Valid mode			Communication mode		
				P	S	T	Byte	Op.	485 Addr.
Pr0.17	Regenerative resistor power rating	50	—	O	O	O	16bit	R/W	0x0023
Pr0.18	Vibration suppression after stopping	0	—	O	O	O	16bit	R/W	
Pr0.19	Micro-vibration suppression	0	—	O	O	O	16bit	R/W	
Pr0.20	External pulse valid edge settings	0	—	O	O	O	16bit	R/W	

[Class 1] Gain adjustment

Code	Label	Default	Activ ation	Valid mode			Communication mode		
				P	S	T	Byte	Op.	485 Addr.
Pr1.00	1 st position loop gain	320	—	O	—	—	16bit	R/W	0x0101
Pr1.01	1 st velocity loop gain	180	—	O	O	O	16bit	R/W	0x0103
Pr1.02	1 st Integral Time Constant of Velocity Loop	310	—	O	O	O	16bit	R/W	0x0105
Pr1.03	1 st velocity detection filter	15	—	O	O	O	16bit	R/W	0x0107
Pr1.04	1 st Torque Filter Time Constant	126	—	O	O	O	16bit	R/W	0x0109
Pr1.05	2 nd Position Loop Gain	380	—	O	—	—	16bit	R/W	0x010B
Pr1.06	2 nd velocity loop gain	180	—	O	O	O	16bit	R/W	0x010D
Pr1.07	2 nd Integral Time Constant of Velocity Loop	10000	—	O	O	O	16bit	R/W	0x010F
Pr1.08	2 nd velocity detection filter	15	—	O	O	O	16bit	R/W	0x0111
Pr1.09	2 nd Torque Filter Time Constant	126	—	O	O	O	16bit	R/W	0x0113
Pr1.10	Velocity feed forward gain	300	—	O	—	—	16bit	R/W	0x0115
Pr1.11	Velocity feed forward filter time constant	50	—	O	—	—	16bit	R/W	0x0117
Pr1.12	Torque feed forward gain	0	—	O	O	—	16bit	R/W	0x0119
Pr1.13	Torque feed forward filter time constant	0	—	O	O	—	16bit	R/W	0x011B
Pr1.14	2 nd gain switching	1	—	O	O	—	16bit	R/W	
Pr1.15	Position control gain switching mode	0	—	O	—	—	16bit	R/W	0x011F
Pr1.16	Position control gain switching delay time	50	—	O	O	—	16bit	R/W	
Pr1.17	Position control gain switching level	50	—	O	—	—	16bit	R/W	0x0123
Pr1.18	Hysteresis at position control switching	33	—	O	—	—	16bit	R/W	0x0125
Pr1.19	Position control switching time	33	—	O	—	—	16bit	R/W	0x0127
Pr1.35	Position command pulse filter time	8	O	O	—	—	16bit	R/W	0x0147
Pr1.37	Special function register	0	—	O	O	O	16bit	R/W	

[Class 2] Vibration Suppression

Code	Label	Default	Activ ation	Valid mode			Communication mode		
				P	S	T	Byte	Op.	485 Addr.
Pr2.00	Adaptive filtering mode settings	0	—	O	O	—	16bit	R/W	0x0201
Pr2.01	1 st notch frequency	4000	—	O	O	O	16bit	R/W	0x0203
Pr2.02	1 st notch width	4	—	O	O	O	16bit	R/W	0x0205
Pr2.03	1 st notch depth	0	—	O	O	O	16bit	R/W	0x0207

Code	Label	Default	Activ ation	Valid mode			Communication mode		
				P	S	T	Byte	Op.	485 Addr.
Pr2.04	2 nd notch frequency	4000	—	0	0	0	16bit	R/W	0x0209
Pr2.05	2 nd notch width	4	—	0	0	0	16bit	R/W	0x020B
Pr2.06	2 nd notch depth	0	—	0	0	0	16bit	R/W	0x020D
Pr2.07	3 rd notch frequency	4000	—	0	0	0	16bit	R/W	0x020F
Pr2.08	3 rd notch width	4	—	0	0	0	16bit	R/W	0x0211
Pr2.09	3 rd notch depth	0	—	0	0	0	16bit	R/W	0x0213
Pr2.14	1 st damping frequency	0	—	0	—	—	16bit	R/W	0x021D
Pr2.16	2 nd damping frequency	0	—	0	—	—	16bit	R/W	0x0221
Pr2.22	Position command smoothing filter	0	Δ	0	—	—	16bit	R/W	0x022D
Pr2.23	Position command FIR filter	0	Δ	0	—	—	16bit	R/W	0x022F

[Class 3] Velocity / Torque Control

Code	Label	Default	Activ ation	Valid mode			Communication mode		
				P	S	T	Byte	Op.	485 Addr.
Pr3.00	Velocity internal/external switching	1	—	—	0	—	16bit	R/W	0x0301
Pr3.01	Velocity command rotational direction selection	0	—	—	0	—	16bit	R/W	0x0303
Pr3.02	Velocity command input gain	500	—	—	0	0	16bit	R/W	0x0305
Pr3.03	Velocity command input inversion	0	—	—	0	—	16bit	R/W	0x0307
Pr3.04	1st speed of velocity setting	0	—	—	0	—	16bit	R/W	0x0309
Pr3.05	2nd speed of velocity setting	0	—	—	0	—	16bit	R/W	0x030B
Pr3.06	3rd speed of velocity setting	0	—	—	0	—	16bit	R/W	0x030D
Pr3.07	4th speed of velocity setting	0	—	—	0	—	16bit	R/W	0x030F
Pr3.08	5th speed of velocity setting	0	—	—	0	—	16bit	R/W	0x0311
Pr3.09	6th speed of velocity setting	0	—	—	0	—	16bit	R/W	0x0313
Pr3.10	7th speed of velocity setting	0	—	—	0	—	16bit	R/W	0x0315
Pr3.11	8th speed of velocity setting	0	—	—	0	—	16bit	R/W	0x0317
Pr3.12	Acceleration time settings	100	—	—	0	—	16bit	R/W	0x0319
Pr3.13	Deceleration time settings	100	—	—	0	—	16bit	R/W	0x031B
Pr3.14	Sigmoid acceleration/deceleration settings	0	0	—	0	—	16bit	R/W	0x031D
Pr3.15	Zero speed clamp function selection	0	—	—	0	—	16bit	R/W	0x031F
Pr3.16	Zero speed clamp level	30	—	—	0	—	16bit	R/W	0x0321
Pr3.17	Torque internal/external switching	0	—	—	—	0	16bit	R/W	0x0323
Pr3.18	Torque command direction selection	0	—	—	—	0	16bit	R/W	0x0325
Pr3.19	Torque command input gain	30	—	—	—	0	16bit	R/W	0x0327
Pr3.20	Torque command input inversion	0	—	—	—	0	16bit	R/W	0x0329
Pr3.21	Velocity limit in torque mode	0	—	—	—	0	16bit	R/W	0x032B
Pr3.22	Torque command	0	—	0	0	0	16bit	R/W	0x032D
Pr3.23	Zero speed delay time in velocity mode	0	—	—	0	—	16bit	R/W	0x032F
Pr3.24	Maximum motor rotational speed	0	—	0	0	0	16bit	R/W	0x0331
Pr3.25	Velocity offset – Logistics	0	—	—	—	0	16bit	R/W	
Pr3.26	Pulse deviation tolerance at disabling - Logistics	0	—	—	—	0	16bit	R/W	

Code	Label	Default	Activ ation	Valid mode			Communication mode		
				P	S	T	Byte	Op.	485 Addr.
Pr3.28	Position gain - Logistics	0	—	—	—	0	16bit	R/W	
Pr3.29	Delay time gain - Logistics	0	—	—	—	0	16bit	R/W	

[Class 4] I/O Monitoring Settings

Code	Label	Default	Activ ation	Valid mode			Communication mode		
				P	S	T	Byte	Op.	485 Addr.
Pr4.00	Input selection DI1	0x1	—	0	0	0	16bit	R/W	0x0401
Pr4.01	Input selection DI2	0x2	—	0	0	0	16bit	R/W	0x0403
Pr4.02	Input selection DI3	0x8	—	0	0	0	16bit	R/W	0x0405
Pr4.03	Input selection DI4	0x4	—	0	0	0	16bit	R/W	0x0407
Pr4.04	Input selection DI5	0x3	—	0	0	0	16bit	R/W	0x0409
Pr4.05	Input selection DI6	0x0	—	0	0	0	16bit	R/W	0x040B
Pr4.10	Output selection DO1	0x2	—	0	0	0	16bit	R/W	0x0415
Pr4.11	Output selection DO2	0x4	—	0	0	0	16bit	R/W	0x0417
Pr4.12	Output selection DO3	0x3	—	0	0	0	16bit	R/W	0x0419
Pr4.22	Analog input 1(AI-1) Zero drift settings	0	—	—	0	0	16bit	R/W	0x042D
Pr4.23	Analog input 1(AI-1) filter	0	—	—	0	0	16bit	R/W	0x042F
Pr4.24	Analog input 1(AI-1) overvoltage settings	0	—	—	0	0	16bit	R/W	0x0431
Pr4.31	Positioning complete range	50	—	0	0	0	16bit	R/W	0x0445
Pr4.32	Positioning complete output setting	50	—	—	0	—	16bit	R/W	0x0447
Pr4.33	INP positioning delay time	1000	—	—	0	—	16bit	R/W	0x0449
Pr4.34	Zero speed	150	—	0	0	0	16bit	R/W	0x044B
Pr4.35	Velocity coincidence range	0	—	0	0	0	16bit	R/W	0x044D
Pr4.36	Reached velocity	30	—	0	0	0	16bit	R/W	0x044F
Pr4.37	Holding brake deactivation delay time	0	—	0	0	0	16bit	R/W	
Pr4.38	Holding brake activation delay time	0	—	0	0	0	16bit	R/W	
Pr4.43	Emergency stop function	0	—	0	0	0	16bit	R/W	0x0457

[Class 5] Extension settings

Code	Label	Default	Activ ation	Valid mode			Communication mode		
				P	S	T	Byte	Op.	485 Addr.
Pr5.00	2nd pulse count per revolution	10000	0	0	—	—	32bit	R/W	0x0500 0x0501
Pr5.01	2nd Command frequency divider/multiplier numerator	1	0	0	—	—	32bit	R/W	0x0502 0x0503
Pr5.02	2nd Command frequency divider/multiplier denominator	1	0	0	—	—	32bit	R/W	0x0504 0x0505
Pr5.04	Driver prohibition input settings	0	—	0	0	0	16bit	R/W	0x0509
Pr5.06	Servo-off mode	0	—	0	0	0	16bit	R/W	0x050D
Pr5.08	DC bus voltage undervoltage	50	—	0	0	0	16bit	R/W	0x0513
Pr5.11	Servo braking torque setting	0	—	0	0	0	16bit	R/W	0x0519
Pr5.12	Overload level setting	0	—	0	0	0	16bit	R/W	0x051B
Pr5.13	Overspeed level setting	0	—	0	0	0	16bit	R/W	
Pr5.15	I/O digital filter	0	0	0	0	0	16bit	R/W	0x051F
Pr5.16	Alarm clearing input	0	—	0	—	—	16bit	R/W	
Pr5.17	Counter clearing input mode	3	—	0	—	—	16bit	R/W	0x0523
Pr5.20	Position unit settings	1	—	0	—	—	16bit	R/W	0x0529
Pr5.21	Torque limit selection	0	—	0	0	0	16bit	R/W	0x052B
Pr5.22	2nd torque limit	300	—	0	0	0	16bit	R/W	0x052D
Pr5.23	Positive torque warning threshold	0	—	0	0	0	16bit	R/W	0x052F
Pr5.24	Negative torque warning threshold	0	—	0	0	0	16bit	R/W	0x0531
Pr5.29	RS485 communication mode	0x5	—	0	0	0	16bit	R/W	0x053B
Pr5.30	RS485 communication Baud rate	4	—	0	0	0	16bit	R/W	0x053D
Pr5.31	RS485 axis address	1	—	0	0	0	16bit	R/W	0x053F
Pr5.32	Max. command pulse input frequency	0	—	0	—	—	16bit	R/W	0x0541
Pr5.33	Communication cycle 1 for RS485	0	—	0	0	0	16bit	R/W	
Pr5.38	Warning auto clearing delay time	0	—	0	0	0	16bit	R/W	
Pr5.39	Enable duration time - Logistics	0	—	0	0	0	16bit	R/W	

[Class 6] Other Settings

Code	Label	Default	Activ ation	Valid mode			Communication mode		
				P	S	T	Byte	Op.	485 Addr.
Pr6.01	Encoder zero position compensation	0	0	0	0	0	16bit	R/W	0x0603
Pr6.03	JOG trial run torque command	350	—	—	—	0	16bit	R/W	0x0607
Pr6.04	JOG trial run velocity command	30	—	0	0	0	16bit	R/W	0x0609
Pr6.05	Position 3rd gain valid time	0	—	0	—	—	16bit	R/W	0x060B
Pr6.06	Position 3rd gain scale factor	100	—	0	—	—	16bit	R/W	0x060D
Pr6.07	Torque command additional value	0	—	0	0	0	16bit	R/W	0x060F
Pr6.08	Positive direction torque compensation value	0	—	0	0	0	16bit	R/W	0x0611
Pr6.09	Negative direction torque compensation value	0	—	0	0	0	16bit	R/W	0x0613
Pr6.11	Current response settings	100	—	0	0	0	16bit	R/W	0x0617
Pr6.12	Encoder zero position torque correction	50	—	0	0	0	16bit	R/W	
Pr6.14	Max. time to stop after disabling	500	—	0	0	0	16bit	R/W	0x061D
Pr6.20	Trial run distance	10	—	0	—	—	16bit	R/W	0x0629
Pr6.21	Trial run waiting time	300	—	0	—	—	16bit	R/W	0x062B
Pr6.22	No. of trial run cycles	5	—	0	—	—	16bit	R/W	0x062D
Pr6.25	Trial run acceleration	200	—	0	0	—	16bit	R/W	0x0633
Pr6.28	Shaft lock current raising time	0	—	0	0	0	16bit	R/W	0x0639
Pr6.29	Shaft lock duration time	0	—	0	0	0	16bit	R/W	0x063B
Pr6.30	Special function registry 1	0x0	—	0	0	0	16bit	R/W	
Pr6.34	Angle for zero electric angle searching	0	—	0	0	0	16bit	R/W	
Pr6.38	Special function registry 2	0x0	—	0	0	0	16bit	R/W	
Pr6.56	Blocked rotor alarm torque threshold	300	—	0	0	0	16bit	R/W	0x0671
Pr6.57	Blocked rotor alarm delay time	400	—	0	0	0	16bit	R/W	0x0673
Pr6.63	Absolute multiturn data upper limit	0	0	0	0	0	16bit	R/W	0x067F

[Class 7] Factory settings

Code	Label	Default	Activ ation	Valid mode			Communication mode		
				P	S	T	Byte	Op.	485 Addr.
Pr7.15	Motor model no.	0x8010							
Pr7.16	Encoder model no.	0x201							
Pr7.23	Encoder wiring extensions	150							
Pr7.28	Regenerative energy alarm window time	0							
Pr7.30	Under voltage point	20							
Pr7.31	Regenerative energy control mode	2							
Pr7.32	Regenerative energy vent on threshold	80							
Pr7.33	Regenerative energy control hysteresis	5							
Pr7.34	Over voltage point	90							
Pr7.48	Enabling delay time	500							
Pr7.50	Motor IIT time settings	0							

[Class 8] Pr-Control Parameters

Code	Label	Default	Activ ation	Valid mode			Communication mode		
				P R	S	T	Byte	Op.	485 Addr.
Pr8.00	PR Control	0	—	O	—	—	16bit	R/W	0x6000
Pr8.01	Path count	16	—	O	—	—	16bit	R/W	0x6001
Pr8.02	Control Operation		—	O	—	—	16bit	R/W	0x6002
Pr8.06	Software positive limit H	0		O			16bit	R/W	0x6006
Pr8.07	Software positive limit (L)	0	—	O	—	—	16bit	R/W	0x6007
Pr8.08	Software negative limit H	0	—	O	—	—	16bit	R/W	0x6008
Pr8.09	Software negative limit (L)	0	—	O	—	—	16bit	R/W	0x6009
Pr8.10	Homing mode	0	—	O	—	—	16bit	R/W	0x600A
Pr8.11	Zero position H	0	—	O	—	—	16bit	R/W	0x600B
Pr8.12	Zero position (L)	0	—	O	—	—	16bit	R/W	0x600C
Pr8.13	Home position off set H	0	—	O	—	—	16bit	R/W	0x600D
Pr8.14	Home position off set (L)	0		O	—	—	16bit	R/W	0x600E
Pr8.15	High homing velocity	200	—	O	—	—	16bit	R/W	0x600F
Pr8.16	Low homing velocity	50	—	O	—	—	16bit	R/W	0x6010
Pr8.17	Homing acceleration	100	—	O	—	—	16bit	R/W	0x6011
Pr8.18	Homing deceleration	100	—	O	—	—	16bit	R/W	0x6012
Pr8.19	Homing torque holding time	100	—	O	—	—	16bit	R/W	0x6013
Pr8.20	Homing torque	100	—	O	—	—	16bit	R/W	0x6014
Pr8.21	Homing overtravel alarm range	0	—	O	—	—	16bit	R/W	0x6015
Pr8.22	Emergency stop at limit deceleration	10	—	O	—	—	16bit	R/W	0x6016
Pr8.23	STP emergency stop deceleration	50	—	O	—	—	16bit	R/W	0x6017
Pr8.24	I/O combination trigger mode	0	—	O	—	—	16bit	R/W	0x601A
Pr8.25	I/O combination filter	5	—	O	—	—	16bit	R/W	0x601B
Pr8.26	S-code current output value	0	—	O	—	—	16bit	R/W	0x601C
Pr8.27	PR warning	0	—	O	—	—	16bit	R/W	0x601D
Pr8.39	JOG velocity	100	—	O	—	—	16bit	R/W	0x6027
Pr8.40	JOG acceleration	100	—	O	—	—	16bit	R/W	0x6028
Pr8.41	JOG deceleration	100	—	O	—	—	16bit	R/W	0x6029
Pr8.42	Command position H	0	—	O	—	—	16bit	R/W	0x602A
Pr8.43	Command position (L)	0	—	O	—	—	16bit	R/W	0x602B
Pr8.44	Motor position H	0	—	O	—	—	16bit	R/W	0x602C
Pr8.45	Motor position (L)	0	—	O	—	—	16bit	R/W	0x602D
Pr8.46	Input I/O status	0	—	O	—	—	16bit	R/W	0x602E
Pr8.47	Output I/O status	0	—	O	—	—	16bit	R/W	0x602F
Pr8.48	Path 0 S-code	0	—	O	—	—	16bit	R/W	0x6030
Pr8.49	Path 1 S-code	0	—	O	—	—	16bit	R/W	0x6031
Pr8.50	Path 2 S-code	0	—	O	—	—	16bit	R/W	0x6032
Pr8.51	Path 3 S-code	0	—	O	—	—	16bit	R/W	0x6033
Pr8.52	Path 4 S-code	0	—	O	—	—	16bit	R/W	0x6034
Pr8.53	Path 5 S-code	0	—	O	—	—	16bit	R/W	0x6035
Pr8.54	Path 6 S-code	0	—	O	—	—	16bit	R/W	0x6036
Pr8.55	Path 7 S-code	0	—	O	—	—	16bit	R/W	0x6037
Pr8.56	Path 8 S-code	0	—	O	—	—	16bit	R/W	0x6038
Pr8.57	Path 9 S-code	0	—	O	—	—	16bit	R/W	0x6039
Pr8.58	Path 10 S-code	0	—	O	—	—	16bit	R/W	0x603A
Pr8.59	Path 11 S-code	0	—	O	—	—	16bit	R/W	0x603B
Pr8.60	Path 12 S-code	0	—	O	—	—	16bit	R/W	0x603C

Code	Label	Default	Activ ation	Valid mode			Communication mode		
				P R	S	T	Byte	Op.	485 Addr.
Pr8.61	Path 13 S-code	0	—	O	—	—	16bit	R/W	0x603D
Pr8.62	Path 14 S-code	0	—	O	—	—	16bit	R/W	0x603E
Pr8.63	Path 15 S-code	0	—	O	—	—	16bit	R/W	0x603F

[Class 9] Pr-Control Path Parameters

Code	Label	Default	Activ ation	Valid mode			Communication mode		
				P R	S	T	Byte	Op.	485 Addr.
Pr9.00	PR0 mode	0	—	O	—	—	16bit	R/W	0x6200
Pr9.01	PR0 position H	0	—	O	—	—	16bit	R/W	0x6201
Pr9.02	PR0 position(L)	0	—	O	—	—	16bit	R/W	0x6202
Pr9.03	PR0 velocity	60	—	O	—	—	16bit	R/W	0x6203
Pr9.04	PR0 acceleration time	100	—	O	—	—	16bit	R/W	0x6204
Pr9.05	PR0 deceleration time	100	—	O	—	—	16bit	R/W	0x6205
Pr9.06	PR0 pause time	0	—	O	—	—	16bit	R/W	0x6206
Pr9.07	PR0 special parameter	0	—	O	—	—	16bit	R/W	0x6207
Pr9.08	PR1 mode	0	—	O	—	—	16bit	R/W	0x6208
Pr9.09	PR1 position H	0	—	O	—	—	16bit	R/W	0x6209
Pr9.10	PR1 position(L)	0	—	O	—	—	16bit	R/W	0x620A
Pr9.11	PR1 velocity	60	—	O	—	—	16bit	R/W	0x620B
Pr9.12	PR1 acceleration time	100	—	O	—	—	16bit	R/W	0x620C
Pr9.13	PR1 deceleration time	100	—	O	—	—	16bit	R/W	0x620D
Pr9.14	PR1 pause time	0	—	O	—	—	16bit	R/W	0x620E
Pr9.15	PR1 special parameter	0	—	O	—	—	16bit	R/W	0x620F
Pr9.16	PR2 mode	0	—	O	—	—	16bit	R/W	0x6210
Pr9.17	PR2 position H	0	—	O	—	—	16bit	R/W	0x6211
Pr9.18	PR2 position(L)	0	—	O	—	—	16bit	R/W	0x6212
Pr9.19	PR2 velocity	60	—	O	—	—	16bit	R/W	0x6213
Pr9.20	PR2 acceleration time	100	—	O	—	—	16bit	R/W	0x6214
Pr9.21	PR2 deceleration time	100	—	O	—	—	16bit	R/W	0x6215
Pr9.22	PR2 pause time	0	—	O	—	—	16bit	R/W	0x6216
Pr9.23	PR2 special parameter	0	—	O	—	—	16bit	R/W	0x6217
Pr9.24	PR3 mode	0	—	O	—	—	16bit	R/W	0x6218
Pr9.25	PR3 position H	0	—	O	—	—	16bit	R/W	0x6219
Pr9.26	PR3 position(L)	0	—	O	—	—	16bit	R/W	0x621A
Pr9.27	PR3 velocity	60	—	O	—	—	16bit	R/W	0x621B
Pr9.28	PR3 acceleration time	100	—	O	—	—	16bit	R/W	0x621C
Pr9.29	PR3 deceleration time	100	—	O	—	—	16bit	R/W	0x621D
Pr9.30	PR3 pause time	0	—	O	—	—	16bit	R/W	0x621E
Pr9.31	PR3 special parameter	0	—	O	—	—	16bit	R/W	0x621F
Pr9.32	PR4 mode	0	—	O	—	—	16bit	R/W	0x6220
Pr9.33	PR4 position H	0	—	O	—	—	16bit	R/W	0x6221
Pr9.34	PR4 position(L)	0	—	O	—	—	16bit	R/W	0x6222
Pr9.35	PR4 velocity	60	—	O	—	—	16bit	R/W	0x6223
Pr9.36	PR4 acceleration time	100	—	O	—	—	16bit	R/W	0x6224
Pr9.37	PR4 deceleration time	100	—	O	—	—	16bit	R/W	0x6225
Pr9.38	PR4 pause time	0	—	O	—	—	16bit	R/W	0x6226
Pr9.39	PR4 special parameter	0	—	O	—	—	16bit	R/W	0x6227

Code	Label	Default	Activ ation	Valid mode			Communication mode		
				P R	S	T	Byte	Op.	485 Addr.
Pr9.40	PR5 mode	0	—	O	—	—	16bit	R/W	0x6228
Pr9.41	PR5 position H	0	—	O	—	—	16bit	R/W	0x6229
Pr9.42	PR5 position(L)	0	—	O	—	—	16bit	R/W	0x622A
Pr9.43	PR5 velocity	60	—	O	—	—	16bit	R/W	0x622B
Pr9.44	PR5 acceleration time	100	—	O	—	—	16bit	R/W	0x622C
Pr9.45	PR5 deceleration time	100	—	O	—	—	16bit	R/W	0x622D
Pr9.46	PR5 pause time	0	—	O	—	—	16bit	R/W	0x622E
Pr9.47	PR5 special parameter	0	—	O	—	—	16bit	R	0x622F
Pr9.48	PR6 mode	0	—	O	—	—	16bit	R/W	0x6230
Pr9.49	PR6 position H	0	—	O	—	—	16bit	R/W	0x6231
Pr9.50	PR6 position(L)	0	—	O	—	—	16bit	R/W	0x6232
Pr9.51	PR6 velocity	60	—	O	—	—	16bit	R/W	0x6233
Pr9.52	PR6 acceleration time	100	—	O	—	—	16bit	R/W	0x6234
Pr9.53	PR6 deceleration time	100	—	O	—	—	16bit	R/W	0x6235
Pr9.54	PR6 pause time	0	—	O	—	—	16bit	R/W	0x6236
Pr9.55	PR6 special parameter	0	—	O	—	—	16bit	R/W	0x6237
Pr9.56	PR7 mode	0	—	O	—	—	16bit	R/W	0x6238
Pr9.57	PR7 position H	0	—	O	—	—	16bit	R/W	0x6239
Pr9.58	PR7 position(L)	0	—	O	—	—	16bit	R/W	0x623A
Pr9.59	PR7 velocity	60	—	O	—	—	16bit	R/W	0x623B
Pr9.60	PR7 acceleration time	100	—	O	—	—	16bit	R/W	0x623C
Pr9.61	PR7 deceleration time	100	—	O	—	—	16bit	R/W	0x623D
Pr9.62	PR7 pause time	0	—	O	—	—	16bit	R/W	0x623E
Pr9.63	PR7 special parameter	0	—	O	—	—	16bit	R/W	0x623F
Pr9.64	PR8 mode	0	—	O	—	—	16bit	R/W	0x6240
Pr9.65	PR8 position H	0	—	O	—	—	16bit	R/W	0x6241
Pr9.66	PR8 position(L)	0	—	O	—	—	16bit	R/W	0x6242
Pr9.67	PR8 velocity	60	—	O	—	—	16bit	R/W	0x6243
Pr9.68	PR8 acceleration time	100	—	O	—	—	16bit	R/W	0x6244
Pr9.69	PR8 deceleration time	100	—	O	—	—	16bit	R/W	0x6245
Pr9.70	PR8 pause time	0	—	O	—	—	16bit	R/W	0x6246
Pr9.71	PR8 special parameter	0	—	O	—	—	16bit	R/W	0x6247
Pr9.72	PR9 mode	0	—	O	—	—	16bit	R/W	0x6248
Pr9.73	PR9 position H	0	—	O	—	—	16bit	R/W	0x6249
Pr9.74	PR9 position(L)	0	—	O	—	—	16bit	R/W	0x624A
Pr9.75	PR9 velocity	60	—	O	—	—	16bit	R/W	0x624B
Pr9.76	PR9 acceleration time	100	—	O	—	—	16bit	R/W	0x624C
Pr9.77	PR9 deceleration time	100	—	O	—	—	16bit	R/W	0x624D
Pr9.78	PR9 pause time	0	—	O	—	—	16bit	R/W	0x624E
Pr9.79	PR9 special parameter	0	—	O	—	—	16bit	R/W	0x624F
Pr9.80	PR10 mode	0	—	O	—	—	16bit	R/W	0x6250
Pr9.81	PR10 position H	0	—	O	—	—	16bit	R/W	0x6251
Pr9.82	PR10 position(L)	0	—	O	—	—	16bit	R/W	0x6252
Pr9.83	PR10 velocity	60	—	O	—	—	16bit	R/W	0x6253
Pr9.84	PR10 acceleration time	100	—	O	—	—	16bit	R/W	0x6254
Pr9.85	PR10 deceleration time	100	—	O	—	—	16bit	R/W	0x6255
Pr9.86	PR10 pause time	0	—	O	—	—	16bit	R/W	0x6256
Pr9.87	PR10 special parameter	0	—	O	—	—	16bit	R/W	0x6257

Code	Label	Default	Activ ation	Valid mode			Communication mode		
				P R	S	T	Byte	Op.	485 Addr.
Pr9.88	PR11 mode	0	—	O	—	—	16bit	R/W	0x6258
Pr9.89	PR11 position H	0	—	O	—	—	16bit	R/W	0x6259
Pr9.90	PR11 position(L)	0	—	O	—	—	16bit	R/W	0x625A
Pr9.91	PR11 velocity	60	—	O	—	—	16bit	R/W	0x625B
Pr9.92	PR11 acceleration time	100	—	O	—	—	16bit	R/W	0x625C
Pr9.93	PR11 deceleration time	100	—	O	—	—	16bit	R/W	0x625D
Pr9.94	PR11 pause time	0	—	O	—	—	16bit	R/W	0x625E
Pr9.95	PR11 special parameter	0	—	O	—	—	16bit	R/W	0x625F
Pr9.96	PR12 mode	0	—	O	—	—	16bit	R/W	0x6260
Pr9.97	PR12 position H	0	—	O	—	—	16bit	R/W	0x6261
Pr9.98	PR12 position(L)	0	—	O	—	—	16bit	R/W	0x6262
Pr9.99	PR12 velocity	60	—	O	—	—	16bit	R/W	0x6263
Pr9.100	PR12 acceleration time	100	—	O	—	—	16bit	R/W	0x6264
Pr9.101	PR12 deceleration time	100	—	O	—	—	16bit	R/W	0x6265
Pr9.102	PR12 pause time	0	—	O	—	—	16bit	R/W	0x6266
Pr9.103	PR12 special parameter	0	—	O	—	—	16bit	R/W	0x6267
Pr9.104	PR13 mode	0	—	O	—	—	16bit	R/W	0x6268
Pr9.105	PR13 position H	0	—	O	—	—	16bit	R/W	0x6269
Pr9.106	PR13 position(L)	0	—	O	—	—	16bit	R/W	0x626A
Pr9.107	PR13 velocity	60	—	O	—	—	16bit	R/W	0x626B
Pr9.108	PR13 acceleration time	100	—	O	—	—	16bit	R/W	0x626C
Pr9.109	PR13 deceleration time	100	—	O	—	—	16bit	R/W	0x626D
Pr9.110	PR13 pause time	0	—	O	—	—	16bit	R/W	0x626E
Pr9.111	PR13 special parameter	0	—	O	—	—	16bit	R/W	0x626F
Pr9.112	PR14 mode	0	—	O	—	—	16bit	R/W	0x6270
Pr9.113	PR14 position H	0	—	O	—	—	16bit	R/W	0x6271
Pr9.114	PR14 position(L)	0	—	O	—	—	16bit	R/W	0x6272
Pr9.115	PR14 velocity	60	—	O	—	—	16bit	R/W	0x6273
Pr9.116	PR14 acceleration time	100	—	O	—	—	16bit	R/W	0x6274
Pr9.117	PR14 deceleration time	100	—	O	—	—	16bit	R/W	0x6275
Pr9.118	PR14 pause time	0	—	O	—	—	16bit	R/W	0x6276
Pr9.119	PR14 special parameter	0	—	O	—	—	16bit	R/W	0x6277
Pr9.120	PR15 mode	0	—	O	—	—	16bit	R/W	0x6278
Pr9.121	PR15 position H	0	—	O	—	—	16bit	R/W	0x6279
Pr9.122	PR15 position(L)	0	—	O	—	—	16bit	R/W	0x627A
Pr9.123	PR15 velocity	60	—	O	—	—	16bit	R/W	0x627B
Pr9.124	PR15 acceleration time	100	—	O	—	—	16bit	R/W	0x627C
Pr9.125	PR15 deceleration time	100	—	O	—	—	16bit	R/W	0x627D
Pr9.126	PR15 pause time	0	—	O	—	—	16bit	R/W	0x627E
Pr9.127	PR15 special parameter	0	—	O	—	—	16bit	R/W	0x627F

[Class B] Status Parameters

Code	Label	Default	Activ ation	Valid mode			Communication mode		
				P	S	T	Byte	Op.	485 Addr.
PrB.00	Software version 1 (DSP)	/	—	0	0	0	16bit	R	0x0B00
PrB.01	Software version 2 (CPLD)	/	—	0	0	0	16bit	R	0x0B01
PrB.02	Software version 3 (Others)	/	—	0	0	0	16bit	R	0x0B02
PrB.03	Current alarm	/	—	0	0	0	16bit	R	0x0B03
PrB.04	Motor not rotating cause	/	—	0	0	0	16bit	R	0x0B04
PrB.05	Driver operation status	/	—	0	0	0	16bit	R	0x0B05
PrB.06	Motor speed (Before filter)	/	—	0	0	0	16bit	R	0x0B06
PrB.07	Motor torque	/	—	0	0	0	16bit	R	0x0B07
PrB.08	Motor current	/	—	0	0	0	16bit	R	0x0B08
PrB.09	Motor speed (After filter)	/	—	0	0	0	16bit	R	0x0B09
PrB.10	DC bus voltage	/	—	0	0	0	16bit	R	0x0B0A
PrB.11	Driver temperature	/	—	0	0	0	16bit	R	0x0B0B
PrB.12	External analog 1	/	—	0	0	0	16bit	R	0x0B0C
PrB.13	External analog 2	/	—	0	0	0	16bit	R	0x0B0D
PrB.14	External analog 3	/	—	0	0	0	16bit	R	0x0B0E
PrB.15	Motor overload rate	/	—	0	0	0	16bit	R	0x0B0F
PrB.16	Vent overload rate	/	—	0	0	0	16bit	R	0x0B10
PrB.17	Physical I/O input status	/	—	0	0	0	16bit	R	0x0B11
PrB.18	Physical I/O output status	/	—	0	0	0	16bit	R	0x0B12
PrB.20	Command position (Command unit)	/	—	0	0	0	32bit	R	0x0B14 0x0B15
PrB.21	Motor position (Command unit)	/	—	0	-	-	32bit	R	0x0B16 0x0B17
PrB.22	Position deviation (Command unit)	/	—	0	0	0	32bit	R	0x0B18 0x0B19
PrB.23	Command position (Encoder unit)	/	—	0	0	0	32bit	R	0x0B1A 0x0B1B
PrB.24	Motor position (Encoder unit)	/	—	0	-	-	32bit	R	0x0B1C 0x0B1D
PrB.25	Position deviation (Encoder unit)	/	—	0	0	0	32bit	R	0x0B1E 0x0B1F
PrB.26	Rotational encoder position feedback	/	—	0	-	-	32bit	R	0x0B20 0x0B21

3.2 Parameters description

3.2.1 [Class 0] Basic Settings

Pr0.00	Label	Model-following/Zero tracking control			Valid mode(s)	P		
	Range	0-10000	Unit	0.1Hz	Default	1		
	Byte length	16bit	Attribute	R/W	485 address	0x0001		
	Valid	At stop						
Model-following bandwidth, also known as model-following control (MFC), is used to control the position loop to improve the responsiveness to commands, speed up positioning time and reduce following error. The effect is obvious especially in low and medium mechanical stiffness.								
		Value	Description					
		0	Disable model following/zero tracking control					
		1	Set bandwidth automatically					
		2~9	Reserved					
		10~2000	Manually set control bandwidth. 30~100 recommended for belt application					

Pr0.01	Label	Control Mode Settings			Valid mode(s)	P	S	T
	Range	0~10	Unit	—	Default	0		
	Byte length	16bit	Attribute	R/W	485 address	0x0003		
	Valid	After restart						
		Value	Description					
			1st mode	2nd mode				
		【0】	Position	—				
		1	Velocity	—				
		2	Torque	—				
		3	Position	Velocity				
		4	Position	Torque				
		5	Velocity	Torque				
		6	PR internal command control	Position Pr0.22=1				
				Velocity Pr0.22=1				
				Torque Pr0.22=2				
		7~10	Reserved					
<ul style="list-style-type: none"> ◆ When 3, 4, 5, 6 combination hybrid mode, 1st and 2nd mode can be chosen accordingly with control mode switching input (C-MODE). C-MODE: Invalid, select 1st mode. C-MODE: Valid, select 2st mode. Please allow some time in between mode switching commands. ◆ Please set Pr0.01 = 6 to switch to other modes from PR mod, then set 2nd mode using Pr0.22. <p><i>C-MODE is defaulted to Normally Open</i></p>								

Pr0.02	Label	Real time Auto Gain Adjusting			Valid mode(s)	P	S	T
	Range	0x0~0xFF F	Unit	—	Default	0x1		
	Byte length	16bit	Attribute	R/W	485 address	0x0005		
	Valid	Immediate						
Value	Category	Settings	Application					
0x00_	Motion setting mode	Used to set motion setting mode, which can be selected according to the motion characteristics or setting requirements. Generally, it is recommended to select mode 1 with good generality when there is no special requirement, mode 2 when rapid positioning is needed. If mode 1 and mode 2 cannot meet the requirements, please choose mode 0.						
		0:Manual	Pr0.03 invalid. Gain value must be adjusted manually and accordingly.					
		1:Standard	Pr0.03 valid. Quick gain adjusting can be achieved by changing Pr0.03 stiffness value. Gain switching is not used in this mode, suitable for applications with requirements for stability.					
		2:Positioning	Pr0.03 valid. Quick gain adjusting can be achieved by changing Pr0.03 stiffness value. This mode is suitable for applications requiring quick positioning. Not recommended for load mounted vertical to ground, or please compensate for the load using Pr6.07					
0x0_0	Load type setting	Used to select the load type, choose according to load-inertia ratio and mechanical structure.						
		0: Rigid structure	This mode prioritizes system responsiveness. Use this mode when there is a relatively rigid structure with low load inertia. Typical application including directly connected high-precision gearbox, lead screw, gears, etc.					
		1:High inertia	For applications with higher load inertia (10 times or above), gain settings take into account both machine stability and responsiveness. Not recommended to set stiffness above 15 for high load inertia.					
		2: Flexible structure	This mode prioritizes system stability. Use this mode when there is low rigidity structure with high load inertia. Typical applications included belts and chains.					
0x_00	reserved							

The setting type combination is a hexadecimal standard, as follows:

Setting type combination	Application type
0X000	Rigid structure + Manual
0X001	Rigid structure +Standard
0X002	Rigid structure +Positioning
0X010	High inertia + Manual
0X011	High inertia + Standard
0X012	High inertia + Positioning
0X020	Flexible structure + Manual
0X021	Flexible structure +Standard
0X022	Flexible structure +Positioning

Pr0.03	Label	Real time auto stiffness adjusting			Valid mode(s)	P	S	T
	Range	50 ~ 81	Unit	—	Default	70		
	Byte length	16bit	Attribute	R/W	485 address	0x0007		
	Valid	Immediate						

Low → Mechanical stiffness → High
 Low → Servo gain → High

81.80.....70.69.68.....51.50

Low → Responsiveness → High

Lower values ensure better system responsiveness and mechanical stiffness but machine vibration might occur, please set accordingly. Recommend to set to around 70 with motor with high inertia.

Pr0.04	Label	Inertia ratio			Valid mode(s)	P	S	T
	Range	0~20000	Unit	%	Default	250		
	Byte length	16bit	Attribute	R/W	485 address	0x0009		
	Valid	Immediate						

$Pr0.04 = (\text{load inertia} / \text{motor rotational inertia}) \times 100\%$

Set inertia ratio according to actual load inertia. When both are uniform, actual motor velocity loop responsiveness and gain settings will be consistent. If inertia ratio is greater than actual value, velocity loop gain settings will be higher and vice versa. For motor with high inertia, Pr0.04 can be left unfilled but optimal setting of Pr0.04 could improve system performance

Pr0.05	Label	Command pulse input selection			Valid mode(s)	P		
	Range	0~1	Unit	—	Default	0		
	Byte length	16bit	Attribute	R/W	485 address	0x000B		
	Valid	After restart						

Value	Description
【0】	Pulse input low speed channel (200/500kHz pulse input)
1	Pulse input high speed channel (4MHz pulse input)

Both channels cannot be used at the same time.

Pr0.06	Label	Command pulse polarity inversion			Valid mode(s)	P		
	Range	0~1	Unit	—	Default	0		
	Byte length	16bit	Attribute	R/W	485 address	0x000D		
	Valid	After restart						

Pr0.06 and Pr0.07 set command pulse input inversion and mode correspondingly.

Pr0.07	Label	Command pulse input mode		Valid mode(s)	P	
	Range	0~3	Unit	—	Default	3
	Byte length	16bit	Attribute	R/W	485 address	0x000F
	Valid	After restart				

Command pulse input

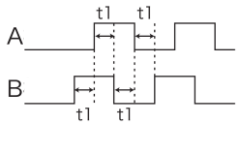
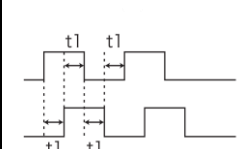
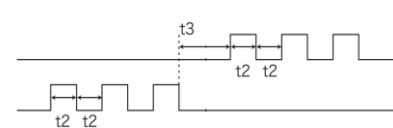
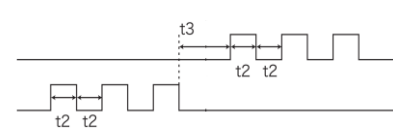
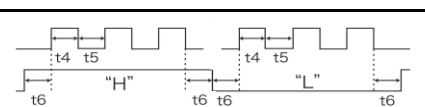
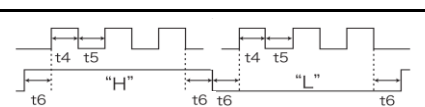
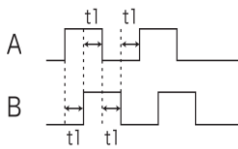
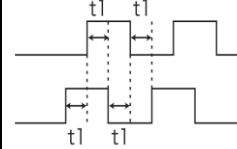
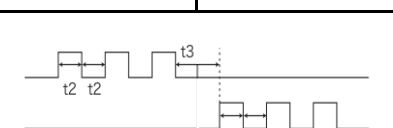
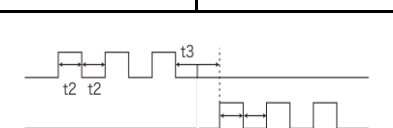
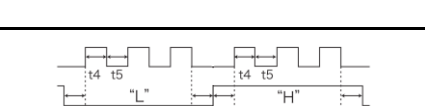
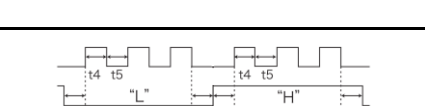
Command Polarity inversion (Pr0.06)	Command pulse input mode settings (Pr0.07)	Command Pulse Mode	Positive signal	Negative signal
【0】	0 or 2	90° phase difference 2 phase pulse (Phase A+ Phase B)		
	1	CW pulse sequence + CCW pulse sequence		
	【3】	Pulse sequence + Directional symbol		
1	0 or 2	90° phase difference 2 phase pulse (Phase A+Phase B)		
	1	CW pulse sequence + CCW pulse sequence		
	3	Pulse sequence + Directional symbol		

Command pulse input signal max. frequency and min. duration needed

Command pulse input interface		Max. Frequency	Min. duration needed (μs)					
			t1	t2	t3	t4	t5	t6
Pulse sequence interface	Differential drive	500 kHz	2	1	1	1	1	1
	Open collector	200 kHz	5	2.5	2.5	2.5	2.5	2.5
	High speed differential drive	4Mhz	0.25	0.125	0.125	0.125	0.125	0.125

Please set >0.1μs for the duration between rising and falling edge of command pulse input signal.

1 revolution with 2500 pulses 2-phase pulse input when Pr0.07=0 or 2, Pr0.08 = 10000;

1 revolution with 10000 pulses 1-phase pulse input when Pr0.07=1 or 3, Pr0.08 = 10000

Pr0.08	Label	1st command pulse count per revolution			Valid mode(s)	P	S	T
	Range	0-67100864	Unit	PULSE	Default	10000		
	Byte length	32bit	Attribute	R/W	485 address	H: 0x0010 L: 0x0011		
	Valid	After restart						
Control will affected if value set is too low. Err1b1 might occur if value < 500. (1) Pr0.08 valid when $\neq 0$: Motor revolution = input pulse count / [Pr0.08 value] (2) Pr0.08 invalid when = 0: Pr0.09 and Pr0.10 valid.								
Pr0.09	Label	1st command frequency divider/multiplier numerator			Valid mode(s)	P		
	Range	1~2147483647	Unit	—	Default	1		
	Byte length	32bit	Attribute	R/W	485 address	H: 0x0012 L: 0x0013		
	Valid	After restart						
Valid when Pr0.08 = 0, please refer to description in Pr0.10.								
Pr0.10	Label	1st command frequency divider/multiplier denominator			Valid mode(s)	P		
	Range	1~2147483647	Unit	—	Default	1		
	Byte length	32bit	Attribute	R/W	485 address	H: 0x0014 L: 0x0015		
	Valid	After restart						
1. Settings: (1) Driver command pulse input count : X (2) Encoder pulse count after frequency divider/multiplier: Y (3) Encoder pulse count per revolution: Z (4) Motor revolution: W 2. Calculation: (1) X, Y $Y = X * Pr0.09 / Pr0.10$ Please keep the value of Pr0.09 and Pr0.10 to be smaller than 2^{24} (16777216). (2) Z Motor with 23-bit motor: $Z = 2^{23} = 8388608$ (3) Y, Z, W $W = Y / Z$ Performance cannot be guaranteed if frequency divider/multiplier ratio is set to extreme values. Err1b1 might occur if $W < 500$.								

Pr0.13	Label	1st torque limit			Valid mode(s)	P	S	T
	Range	0~500	Unit	%	Default	350		
	Byte length	16bit	Attribute	R/W	485 address	0x001B		
	Valid	Immediate						
1st torque limit is set according to ratio percentage of motor rated current. Do not exceed max driver output current. Please refer to Pr5.21 on how to set torque limit.								

Pr0.14	Label	Excessive position deviation			Valid mode(s)	P		
	Range	0~310	Unit	0.1rev	Default	30		
	Byte length	16bit	Attribute	R/W	485 address	0x001D		
	Valid	Immediate						
Please set threshold value for position deviation accordingly. Default factory setting = 30, Er180 will be triggered if positive deviation is in excess of 3 revolutions.								

Pr0.15	Label	Absolute encoder settings			Valid mode(s)	P	S	T
	Range	0~15	Unit	-	Default	0		
	Byte length	16bit	Attribute	R/W	485 address	0x001F		
	Valid	After restart						
Value	Mode	Description						
【0】	Incremental	Doesn't retain position data on power off. Unlimited travel distance.						
1	Multiturn absolute linear	Retrain position data on power off. For applications with fixed travel distance and no multiturn data overflow.						
2	Multiturn absolute rotary	Retrain position data on power off. Actual data feedback in between 0-(Pr6.63+1). Unlimited travel distance.						
3	Single turn absolute	Used when travel distance is within 1 revolution of the encoder. Data overflow will trigger alarm.						
5	Multi turn absolute	Clear multiturn alarm and activate multiturn absolute function. Will switch to multiturn mode once alarm cleared, if remains at 5 after 3s, please solve according to Er153.						
9		Clear multiturn position, reset multiturn alarm and activate multiturn absolute function. Will switch to multiturn mode once alarm cleared, if remains at 9 after 3s, please solve according to Er153. Please disable axis before setting to 9 and home the axis before using.						
Others		Do not use!						

Pr0.16	Label	Regenerative resistance			Valid mode(s)	P	S	T
	Range	25~500	Unit	Ohm	Default	100		
	Byte length	16bit	Attribute	R/W	485 address	0x0021		
	Valid	Immediate						
To set resistance value of regenerative resistor Pr0.16 and Pr0.17set value determine alarm threshold of Er120. If set value > actual regenerative resistance, Er120 occurrence might be delayed.								
Pr0.17	Label	Regenerative resistor power rating			Valid mode(s)	P	S	T
	Range	20~5000	Unit	W	Default	50		
	Byte length	16bit	Attribute	R/W	485 address	0x0023		
	Valid	Immediate						
To set power rating of regenerative resistor. Please refer to table below								
		Drives	Resistance (Ω)	Power rating(W)				
		ELD2-RS7005B	10	30				
		ELD2-RS7010B	10	50				
		ELD2-RS7015B	10	50				
		ELD2-RS7020B	10	100				
		ELD2-RS7030B	10	100/150				

ELD2-RS7040B	10	150/200
ELD2-RS7060B	10	150/200

Pr0.16 and Pr0.17 determines the threshold value of Er120. Please set accordingly or it might trigger false alarm or damage to servo drive.

Note: If external regenerative resistor is used, please set according to its labeled power rating.

3.2.2 [Class 1] Gain adjustments

Pr1.00	Label	1 st position loop gain			Valid mode(s)	P		
	Range	0~30000	Unit	0.1/s	Default	320		
	Byte length	16bit	Attribute	R/W	485 address	0x0101		
	Valid	Immediate						
<p>Higher position loop gain value improves the responsiveness of the servo driver and lessens the positioning time. Position loop gain value shouldn't exceed responsiveness of the mechanical system and take in consideration velocity loop gain, if not it might cause vibration, mechanical noise and overtravel. As velocity loop gain is based on position loop gain, please set both values accordingly. Recommended range: $1.2 \leq \text{Pr1.00}/\text{Pr1.01} \leq 1.8$</p>								
Pr1.01	Label	1 st velocity loop gain			Valid mode(s)	P	S	T
	Range	1~32767	Unit	0.1Hz	Default	180		
	Byte length	16bit	Attribute	R/W	485 address	0x0103		
	Valid	Immediate						
<p>To determine the responsiveness of the velocity loop. If inertia ratio of Pr0.04 is uniform with actual inertia ratio, velocity loop responsiveness = Pr1.01. To increase position loop gain and improve responsiveness of the whole system, velocity loop gain must be set at higher value. Please notice that if the velocity loop gain is too high, it might cause vibration.</p>								
Pr1.02	Label	1 st Integral Time Constant of Velocity Loop			Valid mode(s)	P	S	T
	Range	1~10000	Unit	0.1ms	Default	310		
	Byte length	16bit	Attribute	R/W	485 address	0x0105		
	Valid	Immediate						
<p>The lower the set value, the closer the lag error at stop to 0 but might cause vibration. If the value set is overly large, overshoot, delay of positioning time duration and lowered responsiveness might occur. Set 10000 to deactivate Pr1.02.</p>								

Pr1.03	Label	1 st velocity detection filter			Valid mode(s)	P	S	T
	Range	0~31	Unit	—	Default	15		
	Byte length	16bit	Attribute	R/W	485 address	0x0107		
	Valid	Immediate						

This filter is a low pass filter. It blocks high frequencies which cause system instability from velocity feedback data. The higher the set value, lower frequencies will be blocked and velocity responsiveness will also be lowered. Pr1.03 needs to match velocity loop gain. Please refer to the following table.

Value	Velocity Detection Filter Cut-off Frequency(Hz)	Value	Velocity Detection Filter Cut-off Frequency(Hz)
0	2500	16	750
1	2250	17	700
2	2100	18	650
3	2000	19	600
4	1800	20	550
5	1600	21	500
6	1500	22	450
7	1400	23	400
8	1300	24	350
9	1200	25	300
10	1100	26	250
11	1000	27	200
12	950	28	175
13	900	29	150
14	850	30	125
【15】	800	31	100

Pr1.04	Label	1 st Torque Filter Time Constant			Valid mode(s)	P	S	T
	Range	0~2500	Unit	0.01ms	Default	126		
	Byte length	16bit	Attribute	R/W	485 address	0x0109		
	Valid	Immediate						

To set torque command low-pass filter, add a filter delay time constant to torque command and filter out the high frequencies in the command.

Often used to reduce or eliminate some noise or vibration during motor operation, but it will reduce the responsiveness of current loop, resulting in undermining velocity loop and position loop control. Pr1.04 needs to match velocity loop gain.

Recommended range: $1,000,000 / (2\pi \times \text{Pr1.04}) \geq \text{Pr1.01} \times 4$

For example: Velocity loop gain Pr1.01=180(0.1Hz) which is 18Hz. Time constant of torque filter should be $\text{Pr1.01} \leq 221(0.01\text{ms})$

If mechanical vibration is due to servo driver, adjusting Pr1.04 might eliminate the vibration. The smaller the value, the better the responsiveness but also subjected to machine conditions. If the value is too large, it might lower the responsiveness of current loop.

With higher Pr1.01 value settings and no resonance, reduce Pr1.04 value;

With lower Pr1.01 value settings, increase Pr1.04 value to lower motor noise.

Pr1.05	Label	2 nd Position Loop Gain			Valid mode(s)	P		
	Range	0~30000	Unit	0.1/s	Default	380		
	Byte length	16bit	Attribute	R/W	485 address	0x010B		
	Valid	Immediate						
Pr1.06	Label	2 nd velocity loop gain			Valid mode(s)	P	S	T
	Range	1~32767	Unit	0.1Hz	Default	180		
	Byte length	16bit	Attribute	R/W	485 address	0x010D		
	Valid	Immediate						
Pr1.07	Label	2 nd Integral Time Constant of Velocity Loop			Valid mode(s)	P	S	T
	Range	1~10000	Unit	0.1ms	Default	10000		
	Byte length	16bit	Attribute	R/W	485 address	0x010F		
	Valid	Immediate						
Pr1.08	Label	2 nd velocity detection filter			Valid mode(s)	P	S	T
	Range	0~31	Unit	—	Default	15		
	Byte length	16bit	Attribute	R/W	485 address	0x0111		
	Valid	Immediate						
Pr1.09	Label	2 nd Torque Filter Time Constant			Valid mode(s)	P	S	T
	Range	0~2500	Unit	0.01ms	Default	126		
	Byte length	16bit	Attribute	R/W	485 address	0x0113		
	Valid	Immediate						
Position loop, velocity loop, velocity detection filter, torque command filter each have 2 pairs of gain or time constant (1st and 2nd).								
Pr1.10	Label	Velocity feed forward gain			Valid mode(s)	P		
	Range	0~1000	Unit	0.10%	Default	300		
	Byte length	16bit	Attribute	R/W	485 address	0x0115		
	Valid	Immediate						
Used for decreasing following error caused by low responsiveness of velocity loop. Might cause overshoot or increase in noise if set value is too high.								
Pr1.11	Label	Velocity feed forward filter time constant			Valid mode(s)	P		
	Range	0~6400	Unit	0.01ms	Default	50		
	Byte length	16bit	Attribute	R/W	485 address	0x0117		
	Valid	Immediate						
<p>Set velocity feed forward low pass filter to eliminate high or abnormal frequencies in velocity feed forward command. Often used when position command with low resolution or high electronic gear ration to smoothen velocity feed forward.</p> <p>Position deviation under constant velocity can be lowered with higher velocity feed forward gain. Please to refer to the equation below.</p> <p>Reduce Pr1.11 value to suppress velocity overshoot during deceleration; Increase Pr1.11 value to suppress noise or vibration due to long driver control cycle or position command uneven pulse frequency.</p> <p><Application></p> <p>Set Pr1.11 = 50 (0.5ms) , improve feedforward effect by gradually increase Pr1.10. The equation below can be used to determine the position deviation due to velocity feedforward gain under constant velocity.</p> $\text{Position deviation[Uint]} = \frac{\text{Set velocity}[\frac{\text{Uint}}{\text{s}}]}{\text{Position loop gain[Hz]}} \times \frac{100 - \text{Velocity feed foward gain}[\%]}{100}$								

Pr1.12	Label	Torque feed forward gain			Valid mode(s)	P	S	
	Range	0~1000	Unit	0.1%	Default	0		
	Byte length	16bit	Attribute	R/W	485 address	0x0119		
	Valid	Immediate						
<p>Before using torque feed forward, please set correct inertia ratio Pr0.04. By increasing torque feed forward gain, position deviation on constant acceleration/deceleration can be reduced to close to 0. Under ideal condition and trapezoidal speed profile, position deviation of the whole motion can be reduced to close to 0. In reality, perturbation torque will always exist, hence position deviation can never be 0.</p>								
Pr1.13	Label	Torque feed forward filter time constant			Valid mode(s)	P	S	
	Range	0~6400	Unit	0.01ms	Default	0		
	Byte length	16bit	Attribute	R/W	485 address	0x011B		
	Valid	Immediate						
<p>Low pass filter to eliminate abnormal or high frequencies in torque feed forward command. Usually used when encoder has lower resolution or precision. Noise reduces if torque feed forward filter time constant is set higher but position deviation will increase at acceleration varied points.</p> <p><Application></p> <ul style="list-style-type: none"> • Set Pr1.13 = 50ms, please increase torque forward gain gradually to enable torque feedforward. • By increasing Pr1.13, noise will reduce but position deviation will become larger. 								

Pr1.15	Label	Position control gain switching mode			Valid mode(s)	P		
	Range	0~10	Unit	—	Default	0		
	Byte length	16bit	Attribute	R/W	485 address	0x011F		
	Valid	Immediate						

In position control, set the conditions for gain switching to be valid.

Value	Condition	Gain switching condition
【0】	1 st gain fixed	Fixed on using 1 st gain(Pr1.00-Pr1.04)
1	2 nd gain fixed	Fixed on using 2 nd gain (Pr1.05-Pr1.09)
2	Gain switching input valid	· Gain switching input (GAIN) invalid: 1 st gain. · Gain switching input (GAIN) valid: 2 nd gain. <i>*Default: 1st gain</i>
3	High command torque	Switch to 2 nd gain when set torque command absolute value larger than (level + hysteresis)[%] Switch to 1 st gain when set torque command absolute value smaller than (level + hysteresis)[%]
4-9	Reserved	Reserved
10	Pending position command +actual velocity	Valid for position control. Switch to 2 nd gain if position command $\neq 0$ Switch to 1 st gain if positional command = 0 throughout the duration of delay time and absolute value of actual velocity remains smaller than (level - hysteresis) (r/min)

**** Above 'level' and 'hysteresis' are in correspondence to Pr1.17 Position control gain switching level and Pr1.18 Hysteresis at position control switching.**

Pr1.17	Label	Position control gain switching level			Valid mode(s)	P		
	Range	0~20000	Unit	Mode dependent	Default	50		
	Byte length	16bit	Attribute	R/W	485 address	0x0123		
	Valid	Immediate						

Set threshold value for gain switching to occur.

Unit is mode dependent.

Switching condition	Unit
Position	Encoder pulse count
Velocity	RPM
Torque	%

Please set level \geq hysteresis

Pr1.18	Label	Hysteresis at position control switching			Valid mode(s)	P	
	Range	0~20000	Unit	Mode dependent	Default	33	
	Byte length	16bit	Attribute	R/W	485 address	0x0125	
	Valid	Immediate					

To eliminate the instability of gain switching. Used in combination with Pr1.17 using the same unit.
If level < hysteresis, drive will set internally hysteresis = level.

Pr1.19	Label	Position control switching time			Valid mode(s)	P	
	Range	0~10000	Unit	0.1ms	Default	33	
	Byte length	16bit	Attribute	R/W	485 address	0x0127	
	Valid	Immediate					

During position control, if 1st and 2nd gain difference is too large, to ease torque changes and vibration due to rapid changes in position loop gain, set suitable Pr1.19 value
For example: 1st (pr1.00) <-> 2nd (Pr1.05)

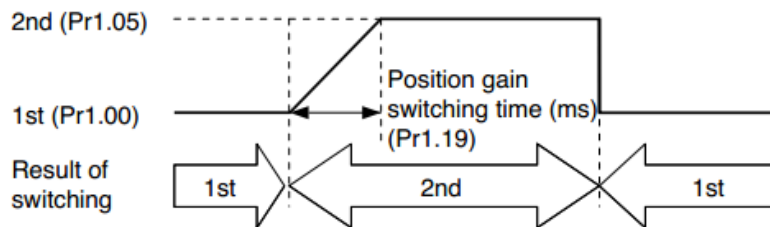

Pr1.35	Label	Position command pulse filter time			Valid mode(s)	P	
	Range	0~200	Unit	0.01us	Default	8	
	Byte length	16bit	Attribute	R/W	485 address	0x0147	
	Valid	After restart					

To filter position setting pulse, getting rid of narrow pulse frequency with interference. Low-speed pulse input unit: 0.05us; High-speed pulse input unit: 0.01us.
If set value is overly large, it will affect the receiving of high frequency command pulse and with high delay time.

Pr1.35 formula:

$$\text{Filter frequency} = \frac{1}{2 \times \text{Pr1.35} \times 0.05\text{us}} \times 1000000\text{Hz}$$

Example: Pr1.35=100, pulse frequency > 100KHz will be filtered;

Pr1.35	Filter frequency	Pr1.35	Filter frequency
0	Null	100	100kHz(500KHz)
8	1.25MHz(6.25MHz)	125	80kHz(400KHz)
10	1MHz (5MHz)	160	62.5kHz(312KHz)
20	500kHz(2.5MHz)	200	50kHz(250KHz)
50	200kHz(1MHz)		
80	125kHz(625KHz)		

3.2.3 [Class 2] Vibration suppression

Pr2.00	Label	Adaptive filtering mode settings			Valid mode(s)	P	S	
	Range	0~4	Unit	—	Default	0		
	Byte length	16bit	Attribute	R/W	485 address	0x0201		
	Valid	Immediate						

Value	Description	
0	Adaptive filter: invalid	Parameters related to 3 rd notch filter remain unchanged
1	Adaptive filter: 1 filter valid for once.	1 adaptive filter becomes valid. 3 rd notch filter related parameters updated accordingly. Pr2.00 switches automatically to 0 once updated.
2	Adaptive filter: 1 filter remains valid	1 adaptive filter becomes valid. 3 rd notch filter related parameters will keep updating accordingly.
3-4	Reserved	-

Pr2.01	Label	1 st notch frequency			Valid mode(s)	P	S	T
	Range	50~4000	Unit	Hz	Default	4000		
	Byte length	16bit	Attribute	R/W	485 address	0x0203		
	Valid	Immediate						

Set center frequency of 1st torque command notch filter.
Set Pr2.01 to 4000 to deactivate notch filter

Pr2.02	Label	1 st notch width			Valid mode(s)	P	S	T
	Range	0~20	Unit	—	Default	4		
	Byte length	16bit	Attribute	R/W	485 address	0x0205		
	Valid	Immediate						

Set notch bandwidth for 1st resonant notch filter.
Under normal circumstances, please use factory default settings. If resonance is under control, in combination with Pr2.01 and Pr2.03, Pr2.02 can be reduced to improve current loop responsiveness which allows higher mechanical stiffness settings

Pr2.03	Label	1 st notch depth			Valid mode(s)	P	S	T
	Range	0~99	Unit	—	Default	0		
	Byte length	16bit	Attribute	R/W	485 address	0x0207		
	Valid	Immediate						

Set notch depth for 1st resonant notch filter.
Under normal circumstances, please use factory default settings. If resonance is under control, in combination with Pr2.01 and Pr2.02, Pr2.03 can be reduced to improve current loop responsiveness which allows higher mechanical stiffness settings

Pr2.04	Label	2 nd notch frequency			Valid mode(s)	P	S	T
	Range	50~4000	Unit	Hz	Default	4000		
	Byte length	16bit	Attribute	R/W	485 address	0x0209		
	Valid	Immediate						
<p>Set center frequency of 2nd torque command notch filter. Set Pr2.04 to 4000 to deactivate notch filter</p>								
Pr2.05	Label	2 nd notch width			Valid mode(s)	P	S	T
	Range	0~20	Unit	—	Default	4		
	Byte length	16bit	Attribute	R/W	485 address	0x020B		
	Valid	Immediate						
<p>Set notch bandwidth for 2nd resonant notch filter. Under normal circumstances, please use factory default settings. If resonance is under control, in combination with Pr2.04 and Pr2.06, Pr2.05 can be reduced to improve current loop responsiveness which allows higher mechanical stiffness settings.</p>								
Pr2.06	Label	2 nd notch depth			Valid mode(s)	P	S	T
	Range	0~99	Unit	—	Default	0		
	Byte length	16bit	Attribute	R/W	485 address	0x020D		
	Valid	Immediate						
<p>Set notch depth for 1st resonant notch filter. When Pr2.06 value is higher, notch depth becomes shallow, phase lag reduces. Under normal circumstances, please use factory default settings. If resonance is under control, in combination with Pr2.04 and Pr2.05, Pr2.06 can be reduced to improve current loop responsiveness which allows higher mechanical stiffness settings.</p>								
Pr2.07	Label	3 rd notch frequency			Valid mode(s)	P	S	T
	Range	50~4000	Unit	Hz	Default	4000		
	Byte length	16bit	Attribute	R/W	485 address	0x020F		
	Valid	Immediate						
<p>Set center frequency of 3rd torque command notch filter. Set Pr2.07 to 4000 to deactivate notch filter</p>								
Pr2.08	Label	3 rd notch width			Valid mode(s)	P	S	T
	Range	0~20	Unit	—	Default	4		
	Byte length	16bit	Attribute	R/W	485 address	0x0211		
	Valid	Immediate						
<p>Set notch depth for 3rd resonant notch filter. When Pr2.06 value is higher, notch depth becomes shallow, phase lag reduces. Under normal circumstances, please use factory default settings. If resonance is under control, in combination with Pr2.04 and Pr2.05, Pr2.06 can be reduced to improve current loop responsiveness which allows higher mechanical stiffness settings.</p>								
Pr2.09	Label	3 rd notch depth			Valid mode(s)	P	S	T
	Range	0~99	Unit	—	Default	0		
	Byte length	16bit	Attribute	R/W	485 address	0x0213		
	Valid	Immediate						
<p>Set notch depth for 3rd resonant notch filter. When Pr2.06 value is higher, notch depth becomes shallow, phase lag reduces. Under normal circumstances, please use factory default settings. If resonance is under control, in combination with Pr2.04 and Pr2.05, Pr2.06 can be reduced to improve current loop responsiveness which allows higher mechanical stiffness settings.</p>								

Pr2.14	Label	1 st damping frequency			Valid mode(s)	P	
	Range	0/10~2000	Unit	0.1Hz	Default	0	
	Byte length	16bit	Attribute	R/W	485 address	0x021D	
	Valid	Immediate					
Set Pr2.14 to 0 to deactivate this parameter. To suppress wobble at load end. Often used when wobble of flexible structure due to high deceleration upon stopping. Especially effective for wobble with frequencies under 100Hz. Set Pr2.15 to wobble frequency (wobble frequency can be determined using tracing function of Motion Studio)							
Pr2.16	Label	2 nd damping frequency			Valid mode(s)	P	
	Range	0/10~2000	Unit	0.1Hz	Default	0	
	Byte length	16bit	Attribute	R/W	485 address	0x0221	
	Valid	Immediate					
Set Pr2.16 to 0 to deactivate this parameter. To suppress wobble at load end. Often used when wobble of flexible structure due to high deceleration upon stopping. Especially effective for wobble with frequencies under 100Hz. Set Pr2.16 to wobble frequency (wobble frequency can be determined using tracing function of Motion Studio)							

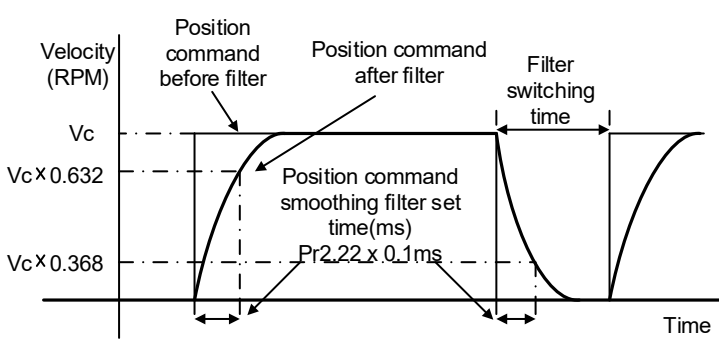
Pr2.22	Label	Position command smoothing filter			Valid mode(s)	P	
	Range	0~32767	Unit	0.1ms	Default	0	
	Byte length	16bit	Attribute	R/W	485 address	0x022D	
	Valid	At stop					
To set time constant of 1 time delay filter of position command. To set time constant of 1 time delay filter, according to target velocity V_c square wave command as show below.							
							
Usually applied when there is rather sharp acceleration which might cause motor overshoot or undershoot. To smoothen command signal, reduces impact to machines and eliminate vibration. If Pr2.22 is set too high, overall time will be lengthened.							

Pr2.23	Label	Position command FIR filter		Valid mode(s)	P	
	Range	0~2500	Unit	0.1ms	Default	0
	Byte length	16bit	Attribute	R/W	485 address	0x022F
	Valid	At stop				

As shown below, when target velocity V_c square wave command reaches V_c , it becomes trapezoidal wave after filtering.

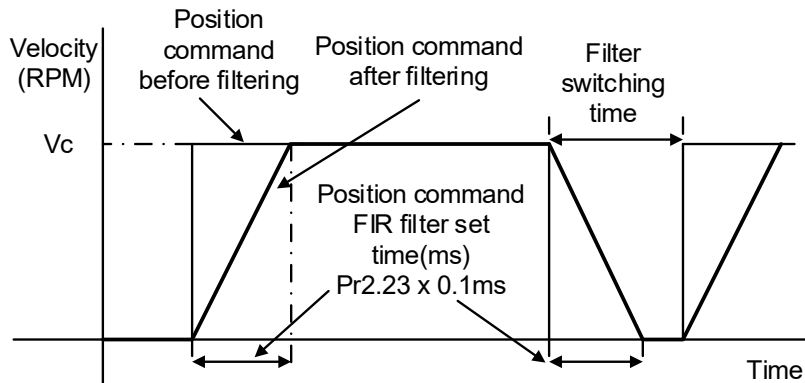

As shown below, when target velocity V_c trapezoidal command reaches V_c , it becomes S wave after filtering.

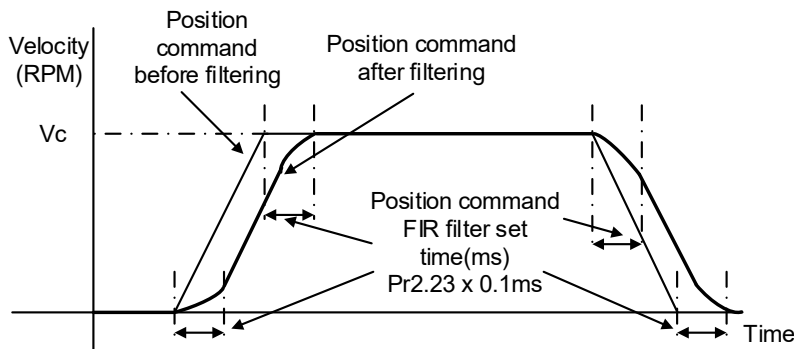

Usually applied when there is rather sharp acceleration which might cause motor overshoot or undershoot. To smoothen command signal, reduces impact to machines and eliminate vibration. If Pr2.23 is set too high, overall time will be lengthened.

Note: Please wait for command to stop and after filter idle time to modify Pr2.23.

$$\text{Filter switching time} = (\text{Pr2.23 set value} \times 0.1\text{ms} + 0.25\text{ms})$$

3.2.4 [Class 3] Velocity/Torque control

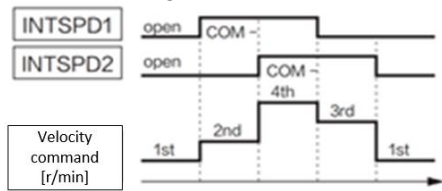
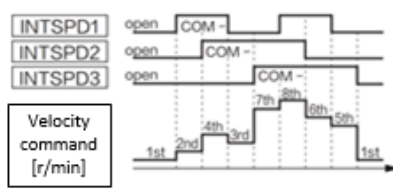
Pr3.00	Label	Velocity internal/external switching		Valid mode(s)	S																																																						
	Range	0~3	Unit	—	Default	1																																																					
	Byte length	16bit	Attribute	R/W	485 address	0x0301																																																					
	Valid	Immediate																																																									
Connect to the right DI to control internal command velocity settings.																																																											
<table border="1"> <thead> <tr> <th>Value</th> <th>Velocity settings</th> </tr> </thead> <tbody> <tr> <td>0</td> <td>Analog - Velocity command (SPR)</td> </tr> <tr> <td>【1】</td> <td>Internal velocity settings 1st – 4th speed (Pr3.04~Pr3.07)</td> </tr> <tr> <td>2</td> <td>Internal velocity settings 1st – 3rd speed (Pr3.04~P3.06) 、 Analog velocity command (SPR)</td> </tr> <tr> <td>3</td> <td>Internal velocity settings 1st – 8th speed (Pr3.00~Pr3.11)</td> </tr> </tbody> </table>						Value	Velocity settings	0	Analog - Velocity command (SPR)	【1】	Internal velocity settings 1 st – 4 th speed (Pr3.04~Pr3.07)	2	Internal velocity settings 1 st – 3 rd speed (Pr3.04~P3.06) 、 Analog velocity command (SPR)	3	Internal velocity settings 1 st – 8 th speed (Pr3.00~Pr3.11)																																												
Value	Velocity settings																																																										
0	Analog - Velocity command (SPR)																																																										
【1】	Internal velocity settings 1 st – 4 th speed (Pr3.04~Pr3.07)																																																										
2	Internal velocity settings 1 st – 3 rd speed (Pr3.04~P3.06) 、 Analog velocity command (SPR)																																																										
3	Internal velocity settings 1 st – 8 th speed (Pr3.00~Pr3.11)																																																										
<table border="1"> <thead> <tr> <th>Value</th> <th>Internal command velocity 1 (INTSPD 1)</th> <th>Internal command velocity 2 (INTSPD2)</th> <th>Internal command velocity 3 (INTSPD3)</th> <th>Velocity command</th> </tr> </thead> <tbody> <tr> <td rowspan="4">1</td> <td>OFF</td> <td>OFF</td> <td rowspan="4">No effect</td> <td>1st speed</td> </tr> <tr> <td>ON</td> <td>OFF</td> <td>2nd speed</td> </tr> <tr> <td>OFF</td> <td>ON</td> <td>3rd speed</td> </tr> <tr> <td>ON</td> <td>ON</td> <td>4th speed</td> </tr> <tr> <td rowspan="4">2</td> <td>OFF</td> <td>OFF</td> <td rowspan="4">No effect</td> <td>1st speed</td> </tr> <tr> <td>ON</td> <td>OFF</td> <td>2nd speed</td> </tr> <tr> <td>OFF</td> <td>ON</td> <td>3rd speed</td> </tr> <tr> <td>ON</td> <td>ON</td> <td>Simulated speed</td> </tr> <tr> <td rowspan="5">3</td> <td colspan="2">Similar to Pr3.00=1</td> <td>OFF</td> <td>1st – 4th speed</td> </tr> <tr> <td>OFF</td> <td>OFF</td> <td>ON</td> <td>5th speed</td> </tr> <tr> <td>ON</td> <td>OFF</td> <td>ON</td> <td>6th speed</td> </tr> <tr> <td>OFF</td> <td>ON</td> <td>ON</td> <td>7th speed</td> </tr> <tr> <td>ON</td> <td>ON</td> <td>ON</td> <td>8th speed</td> </tr> </tbody> </table>						Value	Internal command velocity 1 (INTSPD 1)	Internal command velocity 2 (INTSPD2)	Internal command velocity 3 (INTSPD3)	Velocity command	1	OFF	OFF	No effect	1 st speed	ON	OFF	2 nd speed	OFF	ON	3 rd speed	ON	ON	4 th speed	2	OFF	OFF	No effect	1 st speed	ON	OFF	2 nd speed	OFF	ON	3 rd speed	ON	ON	Simulated speed	3	Similar to Pr3.00=1		OFF	1 st – 4 th speed	OFF	OFF	ON	5 th speed	ON	OFF	ON	6 th speed	OFF	ON	ON	7 th speed	ON	ON	ON	8 th speed
Value	Internal command velocity 1 (INTSPD 1)	Internal command velocity 2 (INTSPD2)	Internal command velocity 3 (INTSPD3)	Velocity command																																																							
1	OFF	OFF	No effect	1 st speed																																																							
	ON	OFF		2 nd speed																																																							
	OFF	ON		3 rd speed																																																							
	ON	ON		4 th speed																																																							
2	OFF	OFF	No effect	1 st speed																																																							
	ON	OFF		2 nd speed																																																							
	OFF	ON		3 rd speed																																																							
	ON	ON		Simulated speed																																																							
3	Similar to Pr3.00=1		OFF	1 st – 4 th speed																																																							
	OFF	OFF	ON	5 th speed																																																							
	ON	OFF	ON	6 th speed																																																							
	OFF	ON	ON	7 th speed																																																							
	ON	ON	ON	8 th speed																																																							
<p>Please change internal command velocity as per diagram below as unexpected axis movement might occurs if 2 command velocities are changed at the same time.</p>																																																											
<div style="display: flex; justify-content: space-around;"> <div style="text-align: center;">  <p>Pr3.00=1 / 2</p> </div> <div style="text-align: center;">  <p>Pr3.00=3</p> </div> </div>																																																											

Pr3.01	Label	Velocity command rotational direction selection			Valid mode(s)	S
	Range	0~1	Unit	—	Default	0
	Byte length	16bit	Attribute	R/W	485 address	0x0303
	Valid	Immediate				

To set positive/negative direction of velocity command

Value	Velocity settings (Analog or internal velocity)	Velocity command sign selection (VC-SIGN)	Velocity command direction
【0】	+	No effect	Positive
	-	No effect	Negative
1	No effect	OFF	Positive
	No effect	ON	Negative

Pr3.02	Label	Velocity command input gain			Valid mode(s)	S
	Range	10~2000	Unit	(r/min)/V	Default	500
	Byte length	16bit	Attribute	R/W	485 address	0x0305
	Valid	Immediate				

To set gain changes from voltage added onto analog velocity command (SPR) to motor command velocity

Pr3.02 sets command input voltage and rotational speed slope.

Factory default:

Pr3.02=500(r/min)/V.

Hence 6V input: 3000 r/min

1. Do not supply more than $\pm 10V$ power for analog velocity command (SPR).
2. If Pr3.02 set value is too large, it might cause vibration.

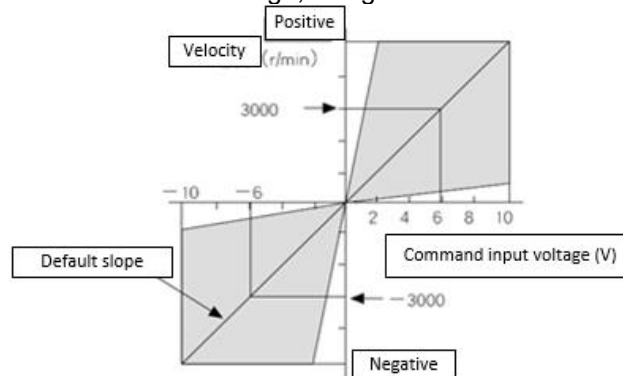

Pr3.03	Label	Velocity command input inversion			Valid mode(s)	S
	Range	0~1	Unit	—	Default	0
	Byte length	16bit	Attribute	R/W	485 address	0x0307
	Valid	Immediate				

To set voltage polarity of analog velocity command.

Only valid when Pr3.01 = 0. When Pr3.01 = 1, rotational direction is only related to VC-SIGN.

Value	Motor rotational direction	
【0】	Not inversed	「 Positive voltage 」 → 「 Positive direction 」 「 Negative voltage 」 → 「 Negative direction 」
1	Inversed	「 Positive voltage 」 → 「 Positive direction 」 「 Negative voltage 」 → 「 Negative direction 」

If there is an external position sensor with different polarity from Pr3.03, motor might undergo abnormal motion.

Pr3.04	Label	1st speed of velocity setting			Valid mode(s)	S
	Range	-10000~10000	Unit	r/min	Default	0
	Byte length	16bit	Attribute	R/W	485 address	0x0309
	Valid	Immediate				
Pr3.05	Label	2nd speed of velocity setting			Valid mode(s)	S
	Range	-10000~10000	Unit	r/min	Default	0
	Byte length	16bit	Attribute	R/W	485 address	0x030B
	Valid	Immediate				
Pr3.06	Label	3rd speed of velocity setting			Valid mode(s)	S
	Range	-10000~10000	Unit	r/min	Default	0
	Byte length	16bit	Attribute	R/W	485 address	0x030D
	Valid	Immediate				
Pr3.07	Label	4th speed of velocity setting			Valid mode(s)	S
	Range	-10000~10000	Unit	r/min	Default	0
	Byte length	16bit	Attribute	R/W	485 address	0x030F
	Valid	Immediate				
Pr3.08	Label	5th speed of velocity setting			Valid mode(s)	S
	Range	-10000~10000	Unit	r/min	Default	0
	Byte length	16bit	Attribute	R/W	485 address	0x0311
	Valid	Immediate				
Pr3.09	Label	6th speed of velocity setting			Valid mode(s)	S
	Range	-10000~10000	Unit	r/min	Default	0
	Byte length	16bit	Attribute	R/W	485 address	0x0313
	Valid	Immediate				
Pr3.10	Label	7th speed of velocity setting			Valid mode(s)	S
	Range	-10000~10000	Unit	r/min	Default	
	Byte length	16bit	Attribute	R/W	485 address	0x0315
	Valid	Immediate				
Pr3.11	Label	8th speed of velocity setting			Valid mode(s)	S
	Range	-10000~10000	Unit	r/min	Default	0
	Byte length	16bit	Attribute	R/W	485 address	0x0317
	Valid	Immediate				

To set internal velocity command 1st -8th speed

Pr3.12	Label	Acceleration time settings			Valid mode(s)	S
	Range	0~10000	Unit	ms/ (1000rpm)	Default	100
	Byte length	16bit	Attribute	R/W	485 address	0x0319
	Valid	Immediate				
Pr3.13	Label	Deceleration time settings			Valid mode(s)	S
	Range	0~10000	Unit	ms/ (1000rpm)	Default	100
	Byte length	16bit	Attribute	R/W	485 address	0x031B
	Valid	Immediate				

Set max acceleration/deceleration for velocity command.

If target velocity = x [rpm], max acceleration = a [unit: rpm/ms], acceleration time = t [ms]

$$\text{Pr3.12} = 1000/a$$

$$\text{Pr3.13} = 1000/a$$

$$a = x/t$$

For example: If motor is to achieve 1500rpm in 30s, $a=1500/30=50\text{rpm/ms}$

Pr3.12 = $1000/a=20$. Hence when Pr3.12 = 20, motor can achieve 1500rpm in 30s.

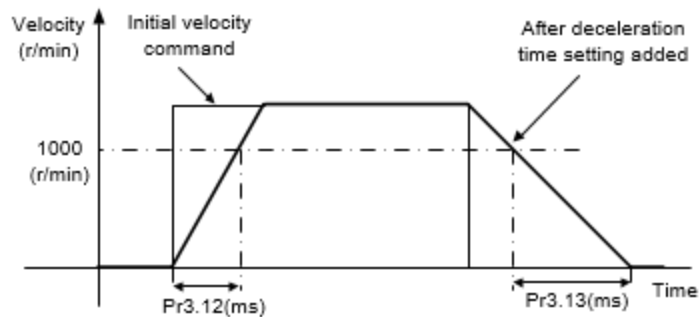

Usually used when there is rapid acceleration or trapezoidal wave velocity command due to many different internal speed segments under velocity control mode which causes instable while motor in motion.

Under velocity control mode, 6083 and 6084 is limited by Pr3.12 and Pr3.13 correspondingly.

Pr3.14	Label	Sigmoid acceleration/deceleration settings			Valid mode(s)	S
	Range	0~1000	Unit	ms	Default	0
	Byte length	16bit	Attribute	R/W	485 address	0x031D
	Valid	After restart				

To set sigmoid acceleration and deceleration turning point in accordance to Pr3.12 and Pr3.13.

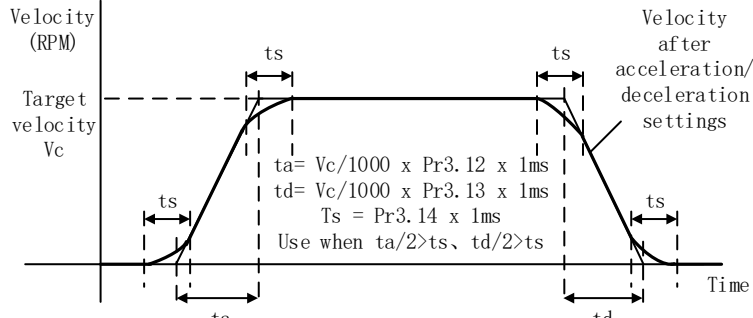

Velocity (RPM)

Target velocity V_c

Velocity after acceleration/deceleration settings

Time

t_a t_s t_s t_d

$t_a = V_c/1000 \times \text{Pr3.12} \times 1\text{ms}$

$t_d = V_c/1000 \times \text{Pr3.13} \times 1\text{ms}$

$T_s = \text{Pr3.14} \times 1\text{ms}$

Use when $t_a/2 > t_s$, $t_d/2 > t_s$

Pr3.15	Label	Zero speed clamp function selection			Valid mode(s)	S
	Range	0~3	Unit	—	Default	0
	Byte length	16bit	Attribute	R/W	485 address	0x031F
	Valid	Immediate				

Value	Zero speed clamp function
0	Invalid: zero speed clamp deactivated
1	Velocity command is forced to 0 when the zero speed clamp (ZEROSPD) input signal is valid.
2	Velocity command is forced to 0 when actual velocity is lower than Pr3.16.
3	Includes conditions from 1 and 2

Pr3.16	Label	Zero speed clamp level			Valid mode(s)	S
	Range	10~2000	Unit	r/min	Default	30
	Byte length	16bit	Attribute	R/W	485 address	0x0321
	Valid	Immediate				

Valid when Pr3.15 = 2/3, velocity command is forced to 0 when actual velocity is lower than Pr3.16 and after static time set in Pr3.23.

Pr3.17	Label	Torque internal/external switching			Valid mode(s)	T
	Range	0~3	Unit		Default	0
	Byte length	16bit	Attribute	R/W	485 address	0x0323
	Valid	Immediate				

Value	Torque command input	Velocity limit input
【0】	Analog input 3(AI 3)	Pr3.21 set value
1	Analog input 3(AI 3)	Analog input 1(AI 1)
2	Pr3.22 set value	Pr3.21 set value

Pr3.18	Label	Torque command direction selection			Valid mode(s)		T
	Range	0~1	Unit	—	Default	0	
	Byte length	16bit	Attribute	R/W	485 address	0x0325	
	Valid	Immediate					
To set torque command positive/negative direction							
		Value	Direction settings				
		【0】	TC-SIGN ON/OFF has no effect on torque direction Torque command input 「 Positive 」 → Positive direction, 「 Negative 」 → Negative direction				
		1	Use TC-SIGN ON/OFF status for torque direction OFF: <i>Positive direction</i> ON: <i>Negative direction</i>				

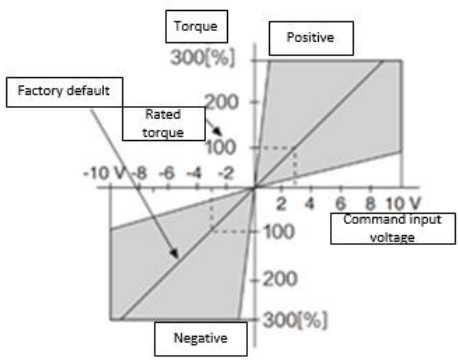
Pr3.19	Label	Torque command input gain			Valid mode(s)		T
	Range	10~100	Unit	0.1V/100%	Default	30	
	Byte length	16bit	Attribute	R/W	485 address	0x0327	
	Valid	Immediate					
To set gain changes from voltage added onto analog torque command (TRQR) to torque command (%)							
<div style="display: flex; justify-content: space-between;"> <div style="width: 45%;"> <ul style="list-style-type: none"> ·Unit: (0.1V/100%)。 ·Set input voltage required for rated output torque. ·Default = 30, which is 3V/100% </div> <div style="width: 50%; text-align: center;">  </div> </div>							

Pr3.20	Label	Torque command input inversion			Valid mode(s)		T
	Range	0~1	Unit	—	Default	0	
	Byte length	16bit	Attribute	R/W	485 address	0x0329	
	Valid	Immediate					
To set voltage polarity of analog torque command. Only valid when Pr3.18 = 0.							
		Value	Motor torque direction				
		【0】	Not inversed	「 Positive voltage 」 → 「 Positive direction 」 「 Negative voltage 」 → 「 Negative direction 」			
		1	Inversed	「 Positive voltage 」 → 「 Positive direction 」 「 Negative voltage 」 → 「 Negative direction 」			

Pr3.21	Label	Velocity limit in torque mode			Valid mode(s)		T	
	Range	0~10000	Unit	r/min	Default	0		
	Byte length	16bit	Attribute	R/W	485 address	0x032B		
	Valid	Immediate						
To set velocity limit in torque control mode. Only valid when Pr3.17 = 0 / 2.								
Pr3.22	Label	Torque command			Valid mode(s)		T	
	Range	0~300	Unit	%	Default	0		
	Byte length	16bit	Attribute	R/W	485 address	0x032D		
	Valid	Immediate						
To set torque limit in torque control mode. Only valid when Pr3.17 = 2. Please refer to Pr3.17.								
Pr3.23	Label	Zero speed delay time in velocity mode			Valid mode(s)		S	
	Range	0~2000	Unit	ms	Default	0		
	Byte length	16bit	Attribute	R/W	485 address	0x032F		
	Valid	Immediate						
To set the time interval between axis reaches zero speed level and the moment it totally stops. Used when axis crawls under velocity mode. Set 0 to deactivate this parameter.								
Pr3.24	Label	Maximum motor rotational speed			Valid mode(s)	P	S	T
	Range	0~10000	Unit	r/min	Default	0		
	Byte length	16bit	Attribute	R/W	485 address	0x0331		
	Valid	Immediate						
To set maximum motor rotational speed but not higher than motor rated speed If Pr3.24 = 0, maximum motor rotational speed = max. speed in motor parameter.								
Pr3.29	Label	Analog 1 clamping voltage			Valid mode(s)			T
	Range	0~20000	Unit	mv	Default	0		
	Byte length	16bit	Attribute	R/W	485 address	0x033B		
	Valid	Immediate						
Only valid when Pr3.17 = 1. When Pr3.17=1, velocity is set to 0 if analog 1 voltage is below Pr3.29 set value.								
Pr3.30	Label	Analog 3 clamping voltage			Valid mode(s)			T
	Range	0~20000	Unit	mv	Default	0		
	Byte length	16bit	Attribute	R/W	485 address	0x033D		
	Valid	Immediate						
Only valid when Pr3.17 = 1 / 0. When Pr3.17=1 / 0, velocity is set to 0 if analog 1 voltage is below Pr3.30 set value.								

3.2.5 [Class 4]I/O Monitoring Settings

Pr4.00	Label	Input selection DI3			Valid mode(s)	P	S	T
	Range	0x00~0xFF	Unit	—	Default	0x2		
	Byte length	16bit	Attribute	R/W	485 address	0x0401		
	Valid	Immediate						

Please refer to the table below to set DI signals and table on the right for corresponding pin and parameters

Signal	Symbol	Value	
		NO	NC
Invalid	—	0	-
Positive limit switch	POT	1	81
Negative limit switch	NOT	2	82
Servo enabled	SRV-ON	3	83
Clear alarm	A-CLR	4	-
Control mode switching	C-MODE	5	85
Gain switching	GAIN	6	86
Clear deviation count	CL	7	-
Command pulse prohibited	INH	8	88
Torque limit switching	TL-SEL	9	89
Command frequency divider/multiplier switching	DIV1	C	8C
Internal command velocity 1	INTSPD1	E	8E
Internal command velocity 2	INTSPD2	F	8F
Internal command velocity 3	INTSPD3	10	90
Zero speed clamp	ZEROSPD	11	91
Velocity command sign	VC-SIGN	12	92
Torque command sign	TC-SIGN	13	93
Forced alarm	E-STOP	14	94

CN1&2 PIN	Input	Parameters
6/20	DI3	Pr4.00
7/21	DI4	Pr4.01
8/22	DI5	Pr4.02
9/23	DI6	Pr4.03

Please don't set anything other than listed in table above.

Normally open (NO) : Valid when input = ON

Normally close (NC): Valid when input = OFF

Er210 might occur if same function is allocated to different channels at the same time

Servo enabled (SRV-ON) has to be allocated to enabled servo drive.

Inputs related to Pr-mode:

Signal	Symbol	Value	
		NO	NC
Trigger command	CTRG	20	A0
Home	HOME	21	A1
Forced stop	STP	22	A2

Signal	Symbol	Value	
		NO	NC
Positive JOG	PJOG	23	A3
Negative JOG	NJOG	24	A4
Positive limit	PL	25	A5

Negative limit	NL	26	A6
Origin	ORG	27	A7
Path address 0	ADD0	28	A8
Path address 1	ADD1	29	A9
Path address 2	ADD2	2A	AA
Path address 3	ADD3	2B	AB

Note: CTRG, HOME are edge triggered, please make sure electronic bits last 1ms or above.

Pr4.01	Label	Input selection DI4			Valid mode(s)	P	S	T
	Range	0x0~0xFF	Unit	—	Default	0x1		
	Byte length	16bit	Attribute	R/W	485 address	0x0403		
	Valid	Immediate						
Pr4.02	Label	Input selection DI5			Valid mode(s)	P	S	T
	Range	0x0~0xFF	Unit	—	Default	0x0		
	Byte length	16bit	Attribute	R/W	485 address	0x0405		
	Valid	Immediate						
Pr4.03	Label	Input selection DI6			Valid mode(s)	P	S	T
	Range	0x0~0xFF	Unit	—	Default	0x6		
	Byte length	16bit	Attribute	R/W	485 address	0x0407		
	Valid	Immediate						
DI4~DI6allocation is the same as DI1. Please refer to Pr4.00.								

Pr4.10	Label	Output selection DO1			Valid mode(s)	P	S	T
	Range	0x0~0xFF	Unit	—	Default	0x3		
	Byte length	16bit	Attribute	R/W	485 address	0x0415		
	Valid	Immediate						

Please allocate DO as per table below. ALARM logic is the opposite of others

Value		Signal	Symbol
NO	NC		
00	80	Invalid	—
01	81	Alarm	ALARM
02	82	Servo-Ready	SRDY
03	83	External brake released	BRK-OFF
04	84	Positioning completed	INP
05	85	At-speed	AT-SPPED
06	86	Torque limit signal	TLC
07	87	Zero speed clamp detection	ZSP
08	88	Velocity coincidence	V-COIN
12	92	Servo Status	SRV-ST
15	95	Positive limit valid	POT-OUT
16	96	Negative limit valid	NOT-OUT
0B	8B	Position command ON/OFF	P-CMD
0F	8F	Velocity command ON/OFF	V-CMD
0D	8D	Velocity limit signal	V-LIMIT
14	94	Position comparison	CMP-OUT

Same signal can be assigned to multiple different outputs.

Normally open(NO): Active low

Normally close(NC): Active high

Err212 might occur if output is allocated to signals other than listed in the table above.

Outputs related to PR-mode

Signal	Symbol	Value	
		NO	NC
Command completed	CMD-OK	20	A0
Path completed	PR-OK	21	A1
Homing done	HOME-OK	22	A2

Note: CMD-OK indicates PR command is sent by axis might not yet be in position. PR-OK indicates axis is in place.

Pr4.11	Label	Output selection DO2			Valid mode(s)	P	S	T
	Range	0x0~0xFF	Unit	—	Default	0x2		
	Byte length	16bit	Attribute	R/W	485 address	0x0417		
	Valid	Immediate						
Pr4.12	Label	Output selection DO3			Valid mode(s)	P	S	T
	Range	0x0~0xFF	Unit	—	Default	0x1		
	Byte length	16bit	Attribute	R/W	485 address	0x0419		
	Valid	Immediate						
DO2/DO3 is allocated by the same method as per DO1. Please refer to Pr4.10.								

Pr4.22	Label	Analog input 1(AI-1) Zero drift settings			Valid mode(s)		S	
	Range	-1860~1860	Unit	5.37mv	Default	0		
	Byte length	16bit	Attribute	R/W	485 address	0x042D		
	Valid	Immediate						
To set zero drift compensation value on analog input 1 voltage for zero drift correction.								
Pr4.23	Label	Analog input 1(AI-1) filter			Valid mode(s)		S	
	Range	0~6400	Unit	0.01ms	Default	0		
	Byte length	16bit	Attribute	R/W	485 address	0x042F		
	Valid	Immediate						
To set a delay filter time coefficient for AI1 input voltage. When filter time takes effect, input voltage will be smoothen.								
Pr4.24	Label	Analog input 1(AI-1) overvoltage settings			Valid mode(s)		S	
	Range	0~100	Unit	0.1V	Default	0		
	Byte length	16bit	Attribute	R/W	485 address	0x0431		
	Valid	Immediate						
Pr4.24 is invalid when set to 0. Er270 might occur when the input voltage of AI1 is higher than the voltage after zero drift correction.								

Pr4.31	Label	Positioning complete range			Valid mode(s)	P	
	Range	0~10000	Unit	Pr5.21 set unit	Default	20	
	Byte length	16bit	Attribute	R/W	485 address	0x043F	
	Valid	Immediate					
<p>To set position deviation range of INP1 positioning completed output signal. INP1 output signal will be valid once position is complete within the range of deviation set. <i>Default unit: 0.00001rev. Can be set on Pr5.21 as command unit (pulse) or encoder unit (pulse)</i></p>							

Pr4.32	Label	Positioning complete output setting			Valid mode(s)	P													
	Range	0~4	Unit	—	Default	1													
	Byte length	16bit	Attribute	R/W	485 address	0x0441													
	Valid	Immediate																	
<p>To set conditions for INP1 output signal to be valid</p> <table border="1" style="width: 100%; border-collapse: collapse;"> <thead> <tr> <th style="width: 10%;">Value</th> <th>Positioning completed signal</th> </tr> </thead> <tbody> <tr> <td>0</td> <td>Signal valid when the position deviation is smaller than Pr4.31</td> </tr> <tr> <td>1</td> <td>Signal valid when there is no position command and position deviation is smaller than Pr4.31</td> </tr> <tr> <td>2</td> <td>Signal valid when there is no position command, zero-speed clamp detection (ZSP) signal is ON and the positional deviation is smaller than Pr4.31</td> </tr> <tr> <td>3</td> <td>Signal valid when there is no position command and position deviation is smaller than Pr4.31. Signal ON when within the time set in Pr4.33 otherwise OFF.</td> </tr> <tr> <td>4</td> <td>When there is no command, position detection starts after the delay time set in Pr4.33. Signal valid when there is no position command and positional deviation is smaller than Pr4.31.</td> </tr> </tbody> </table>								Value	Positioning completed signal	0	Signal valid when the position deviation is smaller than Pr4.31	1	Signal valid when there is no position command and position deviation is smaller than Pr4.31	2	Signal valid when there is no position command, zero-speed clamp detection (ZSP) signal is ON and the positional deviation is smaller than Pr4.31	3	Signal valid when there is no position command and position deviation is smaller than Pr4.31. Signal ON when within the time set in Pr4.33 otherwise OFF.	4	When there is no command, position detection starts after the delay time set in Pr4.33. Signal valid when there is no position command and positional deviation is smaller than Pr4.31.
Value	Positioning completed signal																		
0	Signal valid when the position deviation is smaller than Pr4.31																		
1	Signal valid when there is no position command and position deviation is smaller than Pr4.31																		
2	Signal valid when there is no position command, zero-speed clamp detection (ZSP) signal is ON and the positional deviation is smaller than Pr4.31																		
3	Signal valid when there is no position command and position deviation is smaller than Pr4.31. Signal ON when within the time set in Pr4.33 otherwise OFF.																		
4	When there is no command, position detection starts after the delay time set in Pr4.33. Signal valid when there is no position command and positional deviation is smaller than Pr4.31.																		
Pr4.33	Label	INP positioning delay time			Valid mode(s)	P													
	Range	0~15000	Unit	1ms	Default	0													
	Byte length	16bit	Attribute	R/W	485 address	0x0443													
	Valid	Immediate																	
<p>Valid when Pr4.32 = 3.</p> <table border="1" style="width: 100%; border-collapse: collapse;"> <thead> <tr> <th style="width: 10%;">Set value</th> <th>Positioning completed signal</th> </tr> </thead> <tbody> <tr> <td>0</td> <td>Indefinite delay time, signal ON until next position command</td> </tr> <tr> <td>1-15000</td> <td>OFF within the time set; ON after time set. Switch OFF after receiving next position command.</td> </tr> </tbody> </table>								Set value	Positioning completed signal	0	Indefinite delay time, signal ON until next position command	1-15000	OFF within the time set; ON after time set. Switch OFF after receiving next position command.						
Set value	Positioning completed signal																		
0	Indefinite delay time, signal ON until next position command																		
1-15000	OFF within the time set; ON after time set. Switch OFF after receiving next position command.																		

Pr4.34	Label	Zero speed			Valid mode(s)	P	S	T
	Range	1~2000	Unit	r/min	Default	50		
	Byte length	16bit	Attribute	R/W	485 address	0x0445		
	Valid	Immediate						

To set threshold value for zero speed clamp detection.
 Zero speed clamp detection (ZSP) output signal valid when motor speed goes under the value set in Pr4.34

- Disregard the direction of rotation, valid for both directions.
- Hysteresis of 5RPM. Please refer to diagram on the right side.

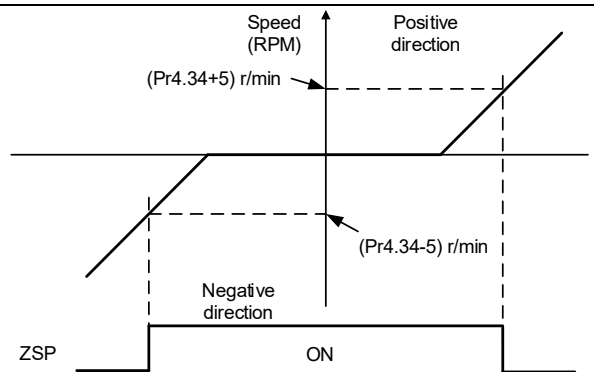

Pr4.35	Label	Velocity coincidence range			Valid mode(s)	S
	Range	10~2000	Unit	r/min	Default	50
	Byte length	16bit	Attribute	R/W	485 address	0x0447
	Valid	Immediate				

If the difference between velocity command and motor actual speed is below Pr4.35, Velocity coincidence (V-COIN) output signal valid.

Due to 10RPM hysteresis:

Velocity coincidence output OFF -> ON timing (Pr4.35 -10) r/min

Velocity coincidence output ON -> OFF timing (Pr4.35 +10) r/min

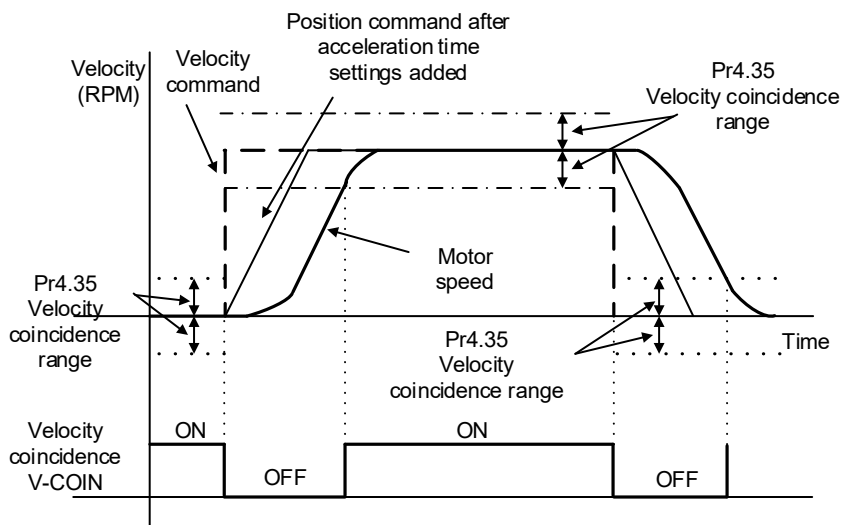

Pr4.36	Label	Reached velocity			Valid mode(s)	S
	Range	10~2000	Unit	r/min	Default	1000
	Byte length	16bit	Attribute	R/W	485 address	0x0449
	Valid	Immediate				

When motor velocity > Pr4.36, AT-speed output signal is valid.
 Detection using 10RPM hysteresis.

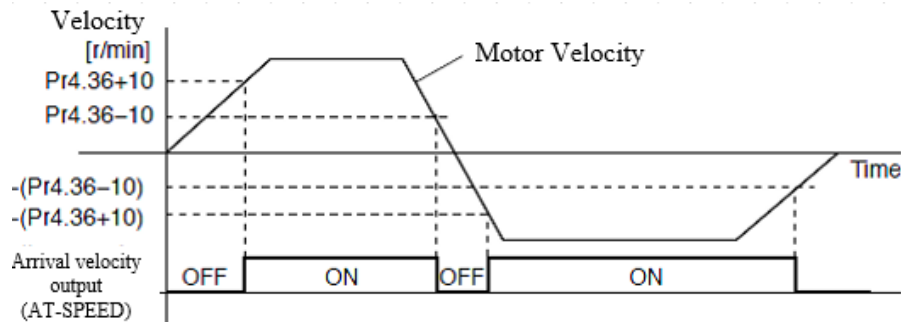

Pr4.37	Label	Holding brake deactivation delay time			Valid mode(s)	P	S	T
	Range	0~3000	Unit	1ms	Default	150		
	Byte length	16bit	Attribute	R/W	485 address	0x044B		
	Valid	Immediate						

To set delay time for holding brake to be activated after motor power off to prevent axis from sliding.

When Pr5.06 = 0, SRV-ON signal is off, holding brake is activated (delay time is determined by Pr4.39 or Pr6.14). Motor powered-off once delay time set in Pr4.37 is due.

Pr4.38	Label	Holding brake activation delay time			Valid mode(s)	P	S	T
	Range	0~3000	Unit	1ms	Default	0		
	Byte length	16bit	Attribute	R/W	485 address	0x044D		
	Valid	Immediate						

To set delay time for holding brake to be released after motor power on. Motor will remain at current position and input command is masked to allow holding brake to be fully released before motor is set in motion.

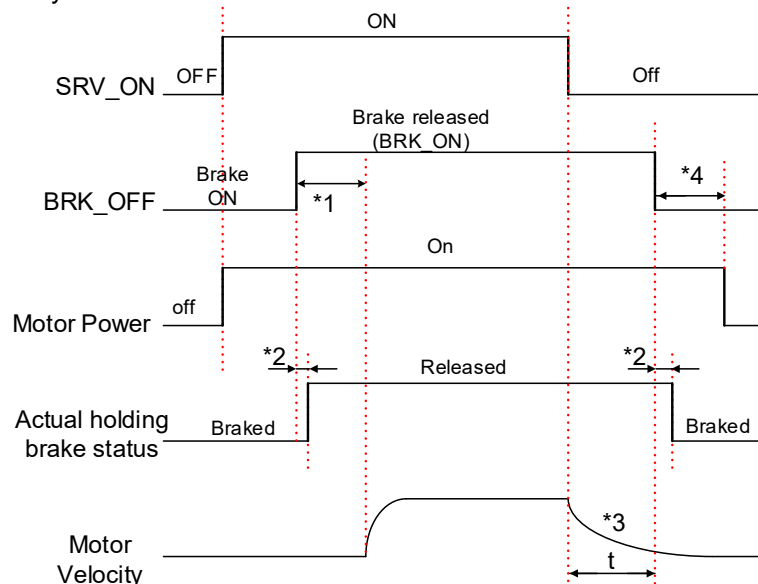

- *1: Delay time set in Pr4.38
- *2: Delay time from the moment BRK_OFF signal is given until actual holding brake is released or BRK_ON signal is given until actual holding brake is activated. It is dependent on the holding brake of the motor.
- *3: Deceleration time is determined by Pr6.14 or if motor speed goes below Pr4.39, whichever comes first. BRK_OFF given after deceleration time.
- *4: Pr4.37 set time value.

Delay time from the moment SRV_ON is given until BRK_OFF switch to BRK_ON, is less than 500ms.

Pr4.43	Label	Emergency stop function			Valid mode(s)	P	S	T
	Range	0~1	Unit	—	Default	0		
	Byte length	16bit	Attribute	R/W	485 address	0x0457		
	Valid	Immediate						
	Value	Description.						
	【0】	Emergency stop is valid, servo driver will be forced to STOP and Err570 occurs.						
	1	Emergency stop is invalid, servo driver will not be forced to STOP. Servo can be enabled once E-STOP signal is cleared.						

3.2.6 [Class 5] Extension Settings

Pr5.00	Label	2 nd pulse count per revolution			Valid mode(s)	P		
	Range	0-67108864	Unit	PULSE	Default	10000		
	Byte length	32bit	Attribute	R/W	485 address	H: 0x0500 L: 0x0501		
	Valid	After restart						
Switch between Pr0.08 and Pr5.00 with DI signal DIV1. When switch to Pr5.00: (1) Pr5.00 valid when ≠ 0: Motor revolution = Input pulse count / [Pr5.00 set value] (2) Pr5.00 invalid when = 0: Actual position pulse count is according to Pr5.01 and Pr5.02. Switching with DIV1 signal only valid when servo drive is re-enabled.								

Pr5.01	Label	2 nd Command frequency divider/multiplier numerator			Valid mode(s)	P		
	Range	1~1073741824	Unit	—	Default	1		
	Byte length	32bit	Attribute	R/W	485 address	H: 0x0502 L: 0x0503		
	Valid	After restart						
To set command pulse input frequency division and multiplication numerator								

Pr5.02	Label	2 nd Command frequency divider/multiplier denominator			Valid mode(s)	P		
	Range	1~1073741824	Unit	—	Default	1		
	Byte length	32bit	Attribute	R/W	485 address	H: 0x0504 L: 0x0505		
	Valid	After restart						
To set command pulse input frequency division and multiplication denominator. Please refer to Pr0.09 and Pr0.10. Switch using DIV1 signal.								

Pr5.04	Label	Driver prohibition input settings			Valid mode(s)	P	S	T
	Range	0/1/2	Unit	—	Default	0		
	Byte length	16bit	Attribute	R/W	485 address	0x0509		
	Valid	Immediate						
To set driver prohibition input (POT/NOT)								
		Value	Description					
		0	POT → Positive direction drive prohibited NOT → Negative direction drive prohibited					
		1	POT and NOT invalid					
		2	Any single sided input from POT or NOT might cause Er260					

Pr5.06	Label	Servo-off mode			Valid mode(s)	P	S	T
	Range	0~1	Unit	—	Default	0		
	Byte length	16bit	Attribute	R/W	485 address	0x050D		
	Valid	Immediate						

To set servo driver disable mode and status.

Set value	Explanation
0	Driver disables after velocity reaching value set in Pr4.39
1	Driver disables immediately, axis in free stopping mode

Pr5.11	Label	Servo braking torque setting			Valid mode(s)	P	S	T
	Range	0~500	Unit	%	Default	0		
	Byte length	16bit	Attribute	R/W	485 address	0x0517		
	Valid	Immediate						

To set torque limit for servo braking mode.

If Pr5.11 = 0, use torque limit as under normal situation.

Please note that if Pr5.11 set value is too low, emergency stop will take longer.

Pr5.12	Label	Overload level setting			Valid mode(s)	P	S	T
	Range	0~115	Unit	%	Default	0		
	Byte length	16bit	Attribute	R/W	485 address	0x0519		
	Valid	Immediate						

- When set to 0, overload level = 100%.

- Set to 0 under regular usage. Lowering overload level will cause motor to overload in shorter time.

- Er100 occurs when driver output current higher than motor rated current (overload)

- Er101 occurs when driver output current lower than motor rated current

Pr5.13	Label	Overspeed level settings			Valid mode(s)	P	S	T
	Range	0~10000	Unit	r/min	Default	0		
	Byte length	16bit	Attribute	R/W	485 address	0x051B		
	Valid	Immediate						

If motor speed exceeds Pr5.13, Er1A0 might occur.

When Pr5.13 = 0, overspeed level = max. motor speed x 1.2

Pr5.15	Label	I/O digital filter			Valid mode(s)	P	S	T
	Range	0~255	Unit	0.1ms	Default	0		
	Byte length	16bit	Attribute	R/W	485 address	0x051F		
	Valid	After restart						

Digital filtering of I/O input. Overly large value set will cause control delay.

Pr5.17	Label	Counter clearing input mode			Valid mode(s)	P		
	Range	0~4	Unit	—	Default	3		
	Byte length	16bit	Attribute	R/W	485 address	0x0523		
	Valid	Immediate						

To set the clearing conditions for deviation counter clearing input signal.

Value	Condition
0/2/4	Invalid
1	Always clear
3	Clear only once (Rising edge trigger)

Pr5.20	Label	Position unit settings			Valid mode(s)	P		
	Range	0~2	Unit	—	Default	1		
	Byte length	16bit	Attribute	R/W	485 address	0x0529		
	Valid	Immediate						
Set unit for position related parameters								
		Value	Unit					
		0	Encoder unit					
		1	Command unit					
		2	0.0001rev					
Command unit: Pulse from host (Affected by electronic gear ratio) Encoder unit: Pulse from encoder (Related to encoder resolution) Pr5.20 can only be modified when axis is disabled as it will clear position data								

Pr5.21	Label	Torque limit selection			Valid mode(s)	P	S	T
	Range	0~6	Unit	—	Default	0		
	Byte length	16bit	Attribute	R/W	485 address	0x052B		
	Valid	Immediate						
		Value	Limit					
		【0】	1 st torque limit Pr0.13					
		1	2 nd torque limit Pr5.22					
		2	TL-SEL OFF		Pr0.13			
			TL-SEL ON		Pr5.22			
		3~4		Reserved				
		5		Pr0.13 → Positive torque limit Pr5.22 → Negative torque limit				

Pr5.22	Label	2 nd torque limit			Valid mode(s)	P	S	T
	Range	0~500	Unit	%	Default	300		
	Byte length	16bit	Attribute	R/W	485 address	0x052D		
	Valid	Immediate						
Pr5.22 is limited by max. torque set in motor parameter.								

Pr5.23	Label	Positive torque warning threshold			Valid mode(s)	P	S	T
	Range	0~300	Unit	%	Default	0		
	Byte length	16bit	Attribute	R/W	485 address	0x052F		
	Valid	Immediate						

Default = 0, which is 95%. Other values only valid when Pr5.21 = 5.
If actual torque higher than threshold, TLC torque limit signal will be valid.

Pr5.24	Label	Negative torque warning threshold			Valid mode(s)	P	S	T
	Range	0~300	Unit	%	Default	0		
	Byte length	16bit	Attribute	R/W	485 address	0x0531		
	Valid	Immediate						

Default = 0, which is 95%. Other values only valid when Pr5.21 = 5.
If actual torque higher than threshold, TLC torque limit signal will be valid.

Pr5.29	Label	RS485 communication mode			Valid mode(s)	P	S	T																												
	Range	0~255	Unit	—	Default	5																														
	Byte length	16bit	Attribute	R/W	485 address	0x053B																														
	Valid	After restart																																		
<table border="1"> <thead> <tr> <th>Value</th> <th>Bit</th> <th>Checksum</th> <th>Stop</th> </tr> </thead> <tbody> <tr> <td>0</td> <td>8</td> <td>Even</td> <td>2</td> </tr> <tr> <td>1</td> <td>8</td> <td>Odd</td> <td>2</td> </tr> <tr> <td>2</td> <td>8</td> <td>Even</td> <td>1</td> </tr> <tr> <td>3</td> <td>8</td> <td>Odd</td> <td>1</td> </tr> <tr> <td>4</td> <td>8</td> <td>Null</td> <td>1</td> </tr> <tr> <td>【5】</td> <td>8</td> <td>Null</td> <td>2</td> </tr> </tbody> </table>									Value	Bit	Checksum	Stop	0	8	Even	2	1	8	Odd	2	2	8	Even	1	3	8	Odd	1	4	8	Null	1	【5】	8	Null	2
Value	Bit	Checksum	Stop																																	
0	8	Even	2																																	
1	8	Odd	2																																	
2	8	Even	1																																	
3	8	Odd	1																																	
4	8	Null	1																																	
【5】	8	Null	2																																	
Pr5.30	Label	RS485 communication Baud rate			Valid mode(s)	P	S	T																												
	Range	0~15	Unit	—	Default	4																														
	Byte length	16bit	Attribute	R/W	485 address	0x053D																														
	Valid	After restart																																		
<table border="1"> <thead> <tr> <th>Value</th> <th>Baud rate</th> <th>Value</th> <th>Baud rate</th> </tr> </thead> <tbody> <tr> <td>0</td> <td>2400bps</td> <td>【4】</td> <td>38400bps</td> </tr> <tr> <td>1</td> <td>4800bps</td> <td>5</td> <td>57600bps</td> </tr> <tr> <td>2</td> <td>9600bps</td> <td>6</td> <td>115200bps</td> </tr> <tr> <td>3</td> <td>19200bps</td> <td></td> <td></td> </tr> </tbody> </table> <p>Baud rate tolerance: 2400~38400bps ± 0.5%, 57600~115200bps ± 2%</p>									Value	Baud rate	Value	Baud rate	0	2400bps	【4】	38400bps	1	4800bps	5	57600bps	2	9600bps	6	115200bps	3	19200bps										
Value	Baud rate	Value	Baud rate																																	
0	2400bps	【4】	38400bps																																	
1	4800bps	5	57600bps																																	
2	9600bps	6	115200bps																																	
3	19200bps																																			
Pr5.31	Label	RS485 axis address			Valid mode(s)	P	S	T																												
	Range	0~127	Unit	—	Default	1																														
	Byte length	16bit	Attribute	R/W	485 address	0x053F																														
	Valid	After restart																																		
<p>When controller is connected to multiple axis and controller needs to identify the axis, Pr5.31 can be used to set the axis ID/address. Please set to a max of 31 if the communication is between RS232 and RS485</p>																																				
Pr5.32	Label	Max. command pulse input frequency			Valid mode(s)	P																														
	Range	0~8000	Unit	kHz	Default	4100																														
	Byte length	16bit	Attribute	R/W	485 address	0x0541																														
	Valid	Immediate																																		
<p>Please set the max. frequency required for command pulse input. Er1B0 will occur, if command pulse input frequency exceeds Pr5.32.</p>																																				

3.2.7 [Class 6] Other settings

Pr6.01	Label	Encoder zero position compensation			Valid mode(s)	P	S	T
	Range	0~360	Unit	Electrical angle	Default	0		
	Byte length	16bit	Attribute	R/W	485 address	0x0603		
	Valid	Power-off						
Zero position compensation for encoder zero drift to avoid abnormality due to zero drift.								

Pr6.03	Label	JOG trial run torque command			Valid mode(s)			T
	Range	0~350	Unit	%	Default	350		
	Byte length	16bit	Attribute	R/W	485 address	0x0607		
	Valid	Immediate						

To set torque for JOG trial run command.

Pr6.04	Label	JOG trial run velocity command			Valid mode(s)	P	S	T
	Range	0~10000	Unit	r/min	Default	30		
	Byte length	16bit	Attribute	R/W	485 address	0x0609		
	Valid	Immediate						

To set velocity for JOG trial run command.

Pr6.05	Label	Position 3 rd gain valid time			Valid mode(s)	P		
	Range	0~10000	Unit	0.1ms	Default	0		
	Byte length	16bit	Attribute	R/W	485 address	0x060B		
	Valid	Immediate						

To set time for 3rd gain to be valid
 Only available in position mode
 When not in use, set Pr6.05=0, Pr6.06=100

Pr6.06	Label	Position 3 rd gain scale factor			Valid mode(s)	P		
	Range	50~1000	Unit	100%	Default	100		
	Byte length	16bit	Attribute	R/W	485 address	0x060D		
	Valid	Immediate						

Set up the 3rd gain by multiplying factor of the 1st gain

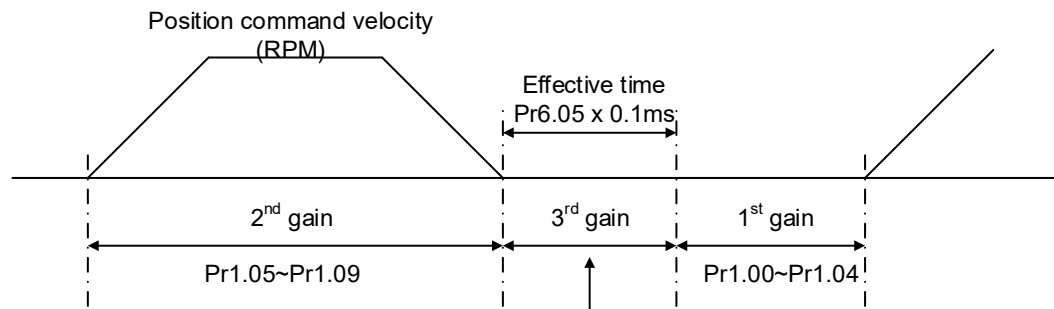

Position loop gain = $Pr1.00 \times Pr6.06/100$
 Velocity loop gain = $Pr1.01 \times Pr6.06/100$
 Velocity loop integral time constant, Velocity detection filter,
 Torque filter time constant still uses 1st gain

Above diagram is illustrated using $Pr1.15 = 7$.

$3^{rd} \text{ gain} = 1^{st} \text{ gain} \times Pr6.06/100$

Only effective under position control mode. 3rd gain valid when $Pr6.05 \neq 0$. Set 3rd gain value in Pr6.06. When 2nd gain switches to 1st gain, it will go through 3rd, switching time is set in Pr1.19.

Pr6.07	Label	Torque command additional value			Valid mode(s)	P	S	T
	Range	-100~100	Unit	%	Default	0		
	Byte length	16bit	Attribute	R/W	485 address	0x060F		
	Valid	Immediate						

To set torque forward feed additional value of vertical axis.

Applicable for loaded vertical axis, compensate constant torque.

Application: When load move along vertical axis, pick any point from the whole motion and stop the load at that particular point with motor enabled but not rotating. Record output torque value from d04, use that value as torque command additional value (compensation value)

Pr6.08	Label	Positive direction torque compensation value			Valid mode(s)	P	S	T
	Range	-100~100	Unit	%	Default	0		
	Byte length	16bit	Attribute	R/W	485 address	0x0611		
	Valid	Immediate						

Pr6.09	Label	Negative direction torque compensation value			Valid mode(s)	P	S	T
	Range	-100~100	Unit	%	Default	0		
	Byte length	16bit	Attribute	R/W	485 address	0x0613		
	Valid	Immediate						

To reduce the effect of mechanical friction in the movement(s) of the axis. Compensation values can be set according to needs for both rotational directions.

Applications:

1. When motor is at constant speed, d04 will deliver torque values.

Torque value in positive direction = T1;

Torque value in negative direction = T2

$$\text{Pr6.08/Pr6.09} = T_f = \frac{|T1 - T2|}{2}$$

Positive/Negative compensation corresponds to actual position feedback.

Positive torque compensation value = $+(Pr6.08=+T_f)$

Negative torque compensation value = $-(Pr6.08=+T_f)$

Pr6.08 = x, Pr6.09 = y; friction compensation value = $|x-y|/2$

Pr6.11	Label	Current response settings			Valid mode(s)	P	S	T
	Range	50~100	Unit	%	Default	100		
	Byte length	16bit	Attribute	R/W	485 address	0x0617		
	Valid	Immediate						
To set driver current loop related effective value ratio.								

Pr6.14	Label	Max. time to stop after disabling			Valid mode(s)	P	S	T
	Range	0~1000	Unit	ms	Default	500		
	Byte length	16bit	Attribute	R/W	485 address	0x061D		
	Valid	Immediate						
<p>To set the max. time allowed for the axis to stop on emergency stop or normal axis disabling. After disabling axis, if motor speed is still higher than Pr4.39 but the time set in Pr6.14 is reached, BRK_ON given and holding brake activated. BRK_ON given time is determined by Pr6.14 or when motor speed goes below Pr4.39, whichever comes first.</p> <p>Applications:</p> <ol style="list-style-type: none"> 1. After disabling axis, if motor speed is still higher than Pr4.39 but the time set in Pr6.14 is reached, BRK_ON given and holding brake activated. 2. After disabling axis, if motor speed is already lower than Pr4.39 but the time set in Pr6.14 is not yet reached, BRK_ON given and holding brake activated. <p>Dynamic brake will be provide the braking function if the function is activated for motors without holding brake.</p>								

Pr6.20	Label	Trial run distance			Valid mode(s)	P		
	Range	0~1200	Unit	0.1rev	Default	10		
	Byte length	16bit	Attribute	R/W	485 address	0x0629		
	Valid	Immediate						
JOG (Position control) : Distance travel of each motion.								
Pr6.21	Label	Trial run waiting time			Valid mode(s)	P		
	Range	0~10000	Unit	ms	Default	300		
	Byte length	16bit	Attribute	R/W	485 address	0x062B		
	Valid	Immediate						
JOG (Position control) : Waiting time interval after each motion cycle								
Pr6.22	Label	No. of trial run cycles			Valid mode(s)	P		
	Range	0~10000	Unit	—	Default	5		
	Byte length	16bit	Attribute	R/W	485 address	0x062D		

	Valid	Immediate				
JOG (Position control) : No. of cycles When Pr6.22, trial run goes into endless cycles.						
Pr6.25	Label	Trial run acceleration			Valid mode(s)	P S
	Range	0~10000	Unit	ms	Default	200
	Byte length	16bit	Attribute	R/W	485 address	0x0633
	Valid	Immediate				
To set the acceleration/deceleration time for JOG command between 0 rpm to 1000 rpm						

Pr6.28	Label	Shaft lock current raising time			Valid mode(s)	P S
	Range	0~32767	Unit	%	Default	0
	Byte length	16bit	Attribute	R/W	485 address	0x0639
	Valid	Immediate				
Pr6.29	Label	Shaft lock duration time			Valid mode(s)	P S
	Range	0~32767	Unit	μs	Default	0
	Byte length	16bit	Attribute	R/W	485 address	0x063B
	Valid	Immediate				

Pr6.56	Label	Blocked rotor alarm torque threshold			Valid mode(s)	P S
	Range	0~300	Unit	%	Default	300
	Byte length	16bit	Attribute	R/W	485 address	0x0671
	Valid	Immediate				
To set the torque threshold of blocked rotor to trigger alarm. (Alarm triggered if torque output% larger than threshold value & under 10rpm) If Pr6.56 = 0, blocked rotor alarm deactivated. If motor speed is 10rpm or above, Err102 won't be triggered.						
Pr6.57	Label	Blocked rotor alarm delay time			Valid mode(s)	P S
	Range	1~10000	Unit	ms	Default	400
	Byte length	16bit	Attribute	R/W	485 address	0x0673
	Valid	Immediate				
To set delay time for blocked rotor alarm. Err102 won't be triggered if time doesn't exceed set time in Pr6.57. Blocked rotor alarm is activated by default, alarm torque threshold = 300%, delay time = 400ms; speed threshold = 10rpm;						

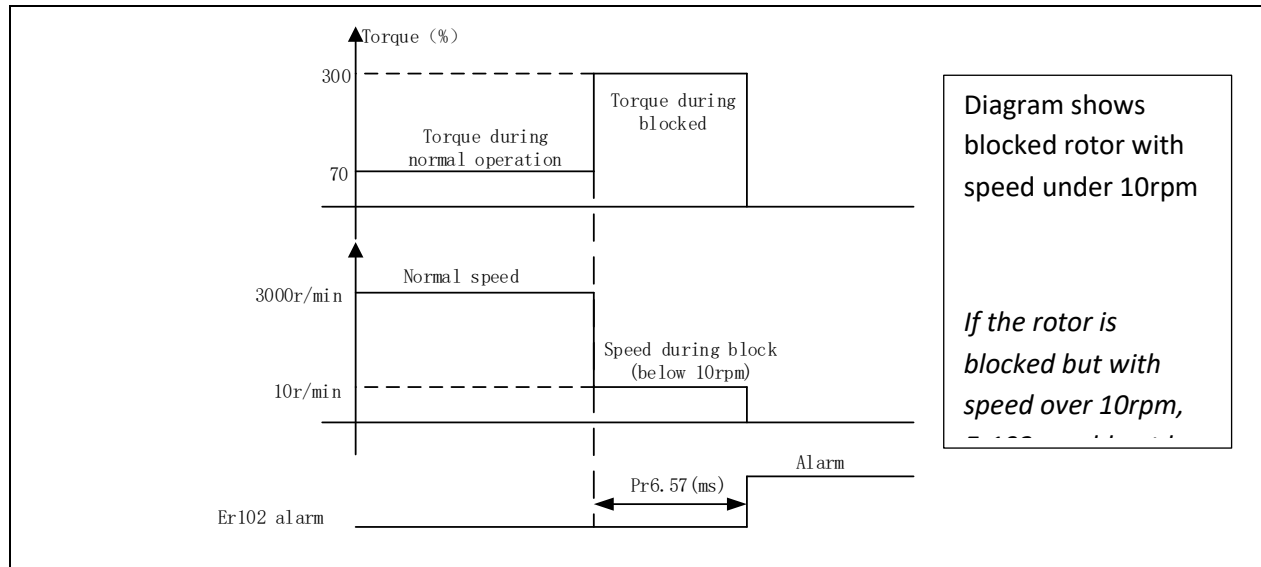

Pr6.63	Label	Absolute multiturn data upper limit			Valid mode(s)	P	S	T
	Range	0~32766	Unit	rev	Default	0		
	Byte length	16bit	Attribute	R/W	485 address	0x067F		
	Valid	After restart						
Use Pr0.15 = 2 in rotational mode, Feedback position cycles between 0 and (Pr6.63+1) x encoder resolution. Absolute multiturn data will be set to 0 if reaches upper limit.								

3.2.8 [Class 7] Factory settings

**Please take precaution when modifying Class 7 parameters. Might cause driver errors*

Pr7.15	Label	Motor model			Valid mode(s)	P	S	T
	Range	0x0~0x7FFF	Unit	—	Default	0x200		
	Byte length	16bit	Attribute	R/W	485 address	0x071F		
	Valid	After restart						
	Value	Description						
	0x100	Read from EEPROM						
	[0x200]	Read from Encoder						
	When Pr7.15 = 0x200(2xx):							
	Parameter	Label						
	Pr7.00	Current loop gain						
	Pr7.01	Current loop integral time						
	Pr7.05	No. of motor pole pairs						
	Pr7.06	Motor phase resistance						
	Pr7.07	Motor D/Q induction						
	Pr7.08	Motor back EMF coefficient						
	Pr7.09	Motor torque coefficient						
	Pr7.10	Motor rated rotational speed						
	Pr7.11	Motor max. rotational speed						
	Pr7.12	Motor rated current						
	Pr7.13	Motor rotor inertia						

	Pr7.14	Driver power rating						
	Pr7.16	Encoder						
	Pr7.17	Motor max. current						
	Pr7.18	Encoder index angle compensation						
Pr7.16	Label	Encoder			Valid mode(s)	P	S	T
	Range	0x0~0x200	Unit	—	Default	Encoder		
	Byte length	16bit	Attribute	R/W	485 address	0x0721		
	Valid	After restart						

3.2.9 [Class 8] PR control parameters

Pr8.00	Label	PR Control			Valid mode(s)	PR
	Range	0 ~ 65535	Unit	/	Default	0
	Byte length	16bit	Attribute	R/W	485 address	0X6000
It is recommended to modify PR control parameters using Motion Studio.						
	Bit	3	2	1	0	
	Description	=1, absolute value memory =0, absolute value with no memory	=1, homing upon power on =0, no homing upon power on	=1, software position limit valid =0, software position limit not valid	=0, CTRG rising edge trigger =1, double edges trigger	
If parameter modifications are done through the front panel or parameters list, please keep in mind that PR control parameters byte are decimal system. For example: If Bit 3, 2, 1, 0 are to be set to 1 (1111). Conversion using decimal system, 1111 = 15, Pr8.00 is to be set to 15.						

Pr8.01	Label	Path count			Valid mode(s)	PR
	Range	16	Unit	/	Default	16
	Byte length	16bit	Attribute	R	485 address	0X6001
16 paths						
Pr8.02	Label	Control Operation			Valid mode(s)	PR
	Range	0x0 ~ 0xFFFF	Unit	/	Default	0x0
	Byte length	16bit	Attribute	R/W	485 address	0X6002

Attributes of Pr8.02 functions are divided into Read/Write. P refers to positioning motion of *N* path. Please refer to the following table.

Attribute	Address	Description
Write	0x01P	<i>N</i> path positioning
Write	0x020	Reset
Write	0x021	Manually set currently position as 0 (Origin)
Write	0x040	Emergency stop
Read	0x000P	Positioning completed. Ready to receive new data
Read	0x01P, 0x020, 0x040	Yet to respond to command
Read	0x10P	Path motion undergoing
Read	0x200	Command completed. Waiting for positioning

Pr8.06	Label	Software positive limit H			Valid mode(s)	PR
	Range	0~ 65535	Unit	Pulse	Default	0
	Byte length	16bit	Attribute	R/W	485 address	0X6006
High bit of software positive limit; (Only valid using 485 communication)						

Pr8.07	Label	Software positive limit (L)			Valid mode(s)	PR
	Range	-2147483648~ 2147483647	Unit	Pulse	Default	0
	Byte length	32bit	Attribute	R/W	485 address	0X6007

To set software positive limit position (32 bit base)
 Using 485 communication, only able to R/W low 16 bit.
 R/W high 16 bit needs to be realized through Pr8.06
 When software positive limit = 994817, 0x000F2E01(Hexadecimal)
 high16bit = 0x000F, hence Pr8.05 reading = 0x000F, controller = 15.
 R/W of high/low bit data is similar when using 485 communication.

Pr8.08	Label	Software negative limit H			Valid mode(s)	PR
	Range	0~ 0x65535	Unit	Pulse	Default	0
	Byte length	16bit	Attribute	R/W	485 address	0X6008

High bit of software negative limit; (Only valid using 485 communication)

Pr8.09	Label	Software negative limit (L)			Valid mode(s)	PR
	Range	-2147483648~ 2147483647	Unit	Pulse	Default	0
	Byte length	32bit	Attribute	R/W	485 address	0X6009

To set software positive limit position.
 Using 485 communication, only able to R/W low 16 bit.
 R/W high 16 bit needs to be realized through Pr8.08.

Pr8.10	Label	Homing mode			Valid mode(s)	PR
	Range	0~ 0xFFFF	Unit	/	Default	0
	Byte length	16bit	Attribute	R/W	485 address	0X600A

To set homing method in PR mode. It is recommended to modify PR control parameters using Motion Studio.

Bit	8 (Z-signal homing)	2-7 (Homing mode)	1 (Specific position after homing)	0 (Homing direction)
Description	=1, homing with Z-signal =0, homing without Z-signal	=0 Limit homing =1 Origin homing =2 Single turn Z homing =3 Torque homing =8 Immediate homing	=1, Yes =0, No	=1, Forward =0, Reverse

Pr8.11	Label	Zero position H			Valid mode(s)	PR
	Range	0 ~ 65535	Unit	/	Default	0
	Byte length	16bit	Attribute	R/W	485 address	0X600B

High bit of zero position; (Only valid using 485 communication)

Pr8.12	Label	Zero position (L)			Valid mode(s)	PR
	Range	-2147483648~ 2147483647	Unit	p	Default	0
	Byte length	32bit	Attribute	R/W	485 address	0X600C

To set zero position.
 Using 485 communication, only able to R/W low 16 bit.
 R/W high 16 bit needs to be realized through Pr8.11.

Pr8.13	Label	Home position offset H			Valid mode(s)	PR
	Range	0 ~ 65535	Unit	/	Default	0
	Byte length	16bit	Attribute	R/W	485 address	0X600D
High bit of home position offset; (Only valid using 485 communication)						
Pr8.14	Label	Home position offset (L)			Valid mode(s)	PR
	Range	-2147483648~ 2147483647	Unit	p	Default	0
	Byte length	32bit	Attribute	R/W	485 address	0X600E
To set home position offset. Using 485 communication, only able to R/W low 16 bit. R/W high 16 bit needs to be realized through Pr8.13.						
Pr8.15	Label	High homing velocity			Valid mode(s)	PR
	Range	1 ~ 6000	Unit	rpm	Default	200
	Byte length	16bit	Attribute	R/W	485 address	0X600F
To set high homing velocity in PR mode.						
Pr8.16	Label	Low homing velocity			Valid mode(s)	PR
	Range	1 ~ 6000	Unit	rpm	Default	50
	Byte length	16bit	Attribute	R/W	485 address	0X6010
To set low homing velocity in PR mode.						
Pr8.17	Label	Homing acceleration			Valid mode(s)	PR
	Range	1 ~ 32767	Unit	ms/Krpm	Default	100
	Byte length	16bit	Attribute	R/W	485 address	0X6011
To set homing acceleration time in PR mode, time needed for 0rpm to accelerate to 1000rpm						
Pr8.18	Label	Homing deceleration			Valid mode(s)	PR
	Range	1 ~ 32767	Unit	ms/Krpm	Default	100
	Byte length	16bit	Attribute	R/W	485 address	0X6012
To set homing deceleration time in PR mode, time needed for 1000rpm to decelerate to 0rpm						
Pr8.19	Label	Homing torque holding time			Valid mode(s)	PR
	Range	0 ~ 65535	Unit	ms	Default	100
	Byte length	16bit	Attribute	R/W	485 address	0X6013
To set homing torque holding time						
Pr8.20	Label	Homing torque			Valid mode(s)	PR
	Range	0 ~ 65535	Unit	%	Default	100
	Byte length	16bit	Attribute	R/W	485 address	0X6014
To set homing torque						
Pr8.21	Label	Homing overtravel alarm range			Valid mode(s)	PR
	Range	0 ~ 65535	Unit	0.1r	Default	0
	Byte length	16bit	Attribute	R/W	485 address	0X6015
To set homing overtravel alarm threshold.						
Pr8.22	Label	Emergency stop at limit deceleration			Valid mode(s)	PR
	Range	1 ~ 32767	Unit	ms/Krpm	Default	10
	Byte length	16bit	Attribute	R/W	485 address	0X6016
To set position limit emergency stop deceleration.						

Pr8.23	Label	STP emergency stop deceleration			Valid mode(s)	PR
	Range	1 ~ 32767	Unit	ms/Krpm	Default	50
	Byte length	16bit	Attribute	R/W	485 address	0X6017
To set STP emergency stop deceleration.						

Pr8.26	Label	I/O combination trigger mode			Valid mode(s)	PR
	Range	0 ~ 65535	Unit	/	Default	0
	Byte length	16bit	Attribute	R/W	485 address	0X601A

Value	Description
【0】	Disable I/O combination trigger mode. Uses I/O CTRG signal edge trigger.
1	Enable I/O combination trigger. Valid when HOME-OK signal is valid.
2	Enable I/O combination trigger. HOME-OK signal not required.

IO combination trigger select path using ADD0~ADD3. Trigger mode is set in Pr8.26.

ADD3	ADD2	ADD1	ADD0	Path selection
OFF	OFF	OFF	OFF	Path 0 (Non-action)
OFF	OFF	OFF	ON	Path1
OFF	OFF	ON	OFF	Path2
OFF	OFF	ON	ON	Path3
OFF	ON	OFF	OFF	Path4
OFF	ON	OFF	ON	Path5
OFF	ON	ON	OFF	Path6
OFF	ON	ON	ON	Path7
ON	OFF	OFF	OFF	Path8
ON	OFF	OFF	ON	Path9
ON	OFF	ON	OFF	Path10
ON	OFF	ON	ON	Path11
ON	ON	OFF	OFF	Path12
ON	ON	OFF	ON	Path13
ON	ON	ON	OFF	Path14
ON	ON	ON	ON	Path15

Pr8.27	Label	I/O combination filter			Valid mode(s)	PR
	Range	0 ~ 65535	Unit	ms	Default	5
	Byte length	16bit	Attribute	R/W	485 address	0X601B

To set I/O combination filter time.

Pr8.28	Label	S-code current output value			Valid mode(s)	PR
	Range	0 ~ 65535	Unit	/	Default	0
	Byte length	16bit	Attribute	R/W	485 address	0X601C

S-code (Status code) is the S-code of currently operating PR positioning data. Every PR path has a S-code setting.

S-code	Sx.H		Sx.L	
Bit	15	8-14	7	0-6
Description	S-code valid when completed. 0: Invalid, retain previous value 1: Valid	S-code upon completion	S-code valid upon activation 0: Invalid 1: Valid	S-code upon activation

Sequence diagram

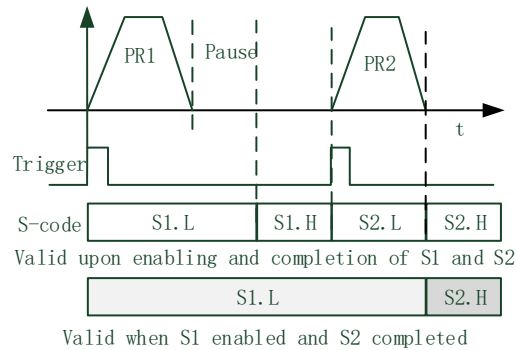

S-code bit	bit0/8	bit1/9	bit2/10	bit3/11	bit4/12	bit5/13	Bit6/14
SDx	SD0	SD1	SD2	SD3	SD4	SD5	SD6

Pr8.29	Label	PR warning			Valid mode(s)	PR
	Range	0x0~0x20F	Unit	/	Default	0
	Byte length	16bit	Attribute	R/W	485 address	0X601D

Address	Warning
0	Reset new command automatically
0x100	Position limit error during homing
0x101	Emergency stop. Homing not completed
0x102	Homing overtravel alarm
0x20x	Position limit error on Path N

Pr8.39	Label	JOG velocity			Valid mode(s)	PR
	Range	0 ~ 65535	Unit	rpm	Default	100
	Byte length	16bit	Attribute	R	485 address	0X6027

Set JOG velocity in PR mode.

Pr8.40	Label	JOG acceleration			Valid mode(s)	PR
	Range	0 ~ 65535	Unit	ms/Krpm	Default	100
	Byte length	16bit	Attribute	R	485 address	0X6028

Set JOG acceleration in PR mode.

Pr8.41	Label	JOG deceleration			Valid mode(s)	PR
	Range	0 ~ 65535	Unit	ms/Krpm	Default	100
	Byte length	16bit	Attribute	R	485 address	0X6029
Set JOG deceleration in PR mode.						

Pr8.42	Label	Command position H			Valid mode(s)	PR
	Range	0 ~ 65535	Unit	/	Default	
	Byte length	16bit	Attribute	R	485 address	0X602A
High bit of command position; (Only valid using 485 communication)						

Pr8.43	Label	Command position (L)			Valid mode(s)	PR
	Range	-2147483648~ 2147483647	Unit	p	Default	
	Byte length	32bit	Attribute	R	485 address	0X602B

To set PR-motion command position.
Using 485 communication, only able to R/W low 16 bit.
R/W high 16 bit needs to be realized through Pr8.42.

Pr8.44	Label	Motor position H			Valid mode(s)	PR
	Range	0~ 0xFFFF	Unit	/	Default	
	Byte length	16bit	Attribute	R	485 address	0X602C
High bit of command position; (Only valid using 485 communication)						

Pr8.45	Label	Motor position (L)			Valid mode(s)	PR
	Range	-2147483648~ 2147483647	Unit	p	Default	
	Byte length	32bit	Attribute	R	485 address	0X602D

Using 485 communication, only able to R/W low 16 bit.
R/W high 16 bit needs to be realized through Pr8.44.

Pr8.46	Label	Input I/O status			Valid mode(s)	PR
	Range	0 ~ 65535	Unit	/	Default	
	Byte length	16bit	Attribute	R	485 address	0X602E

Input I/O status, displays in decimal system. Convert to binary system to determine which bit is valid.

Pr8.47	Label	Output I/O status			Valid mode(s)	PR
	Range	0 ~ 65535	Unit	/	Default	
	Byte length	16bit	Attribute	R	485 address	0X602F

Output I/O status, displays in decimal system. Convert to binary system to determine which bit is valid.

Pr8.48	Label	Path 0 S-code			Valid mode(s)	PR
	Range	0 ~ 65535	Unit	/	Default	0
	Byte length	16bit	Attribute	R	485 address	0X6030

Please refer to Pr8.28 for S-code setting.

Pr8.49	Label	Path 1 S-code			Valid mode(s)	PR
	Range	0 ~ 65535	Unit	/	Default	0
	Byte length	16bit	Attribute	R	485 address	0X6031

Please refer to Pr8.28 for S-code setting.

Pr8.50	Label	Path 2 S-code			Valid mode(s)	PR
	Range	0 ~ 65535	Unit	/	Default	0
	Byte length	16bit	Attribute	R	485 address	0X6032
Please refer to Pr8.28 for S-code setting.						

Pr8.51	Label	Path 3 S-code			Valid mode(s)	PR
	Range	0 ~ 65535	Unit	/	Default	0
	Byte length	16bit	Attribute	R	485 address	0X6033
Please refer to Pr8.28 for S-code setting.						

Pr8.52	Label	Path 4 S-code			Valid mode(s)	PR
	Range	0 ~ 65535	Unit	/	Default	0
	Byte length	16bit	Attribute	R	485 address	0X6034
Please refer to Pr8.28 for S-code setting.						

Pr8.53	Label	Path 5 S-code			Valid mode(s)	PR
	Range	0 ~ 65535	Unit	/	Default	0
	Byte length	16bit	Attribute	R	485 address	0X6035
Please refer to Pr8.28 for S-code setting.						

Pr8.54	Label	Path 6 S-code			Valid mode(s)	PR
	Range	0 ~ 65535	Unit	/	Default	0
	Byte length	16bit	Attribute	R	485 address	0X6036
Please refer to Pr8.28 for S-code setting.						

Pr8.55	Label	Path 7 S-code			Valid mode(s)	PR
	Range	0 ~ 65535	Unit	/	Default	0
	Byte length	16bit	Attribute	R	485 address	0X6037
Please refer to Pr8.28 for S-code setting.						

Pr8.56	Label	Path 8 S-code			Valid mode(s)	PR
	Range	0 ~ 65535	Unit	/	Default	0
	Byte length	16bit	Attribute	R	485 address	0X6038
Please refer to Pr8.28 for S-code setting.						

Pr8.57	Label	Path 9 S-code			Valid mode(s)	PR
	Range	0 ~ 65535	Unit	/	Default	0
	Byte length	16bit	Attribute	R	485 address	0X6039
Please refer to Pr8.28 for S-code setting.						

Pr8.58	Label	Path 10 S-code			Valid mode(s)	PR
	Range	0 ~ 65535	Unit	/	Default	0
	Byte length	16bit	Attribute	R	485 address	0X603A
Please refer to Pr8.28 for S-code setting.						

Pr8.59	Label	Path 11 S-code			Valid mode(s)	PR
	Range	0 ~ 65535	Unit	/	Default	0
	Byte length	16bit	Attribute	R	485 address	0X603B
Please refer to Pr8.28 for S-code setting.						

Pr8.60	Label	Path 12 S-code			Valid mode(s)	PR
	Range	0 ~ 65535	Unit	/	Default	0
	Byte length	16bit	Attribute	R	485 address	0X603C
Please refer to Pr8.28 for S-code setting.						

Pr8.61	Label	Path 13 S-code			Valid mode(s)	PR
	Range	0 ~ 65535	Unit	/	Default	0
	Byte length	16bit	Attribute	R	485 address	0X603D
Please refer to Pr8.28 for S-code setting.						

Pr8.62	Label	Path 14 S-code			Valid mode(s)	PR
	Range	0 ~ 65535	Unit	/	Default	0
	Byte length	16bit	Attribute	R	485 address	0X603E
Please refer to Pr8.28 for S-code setting.						

Pr8.63	Label	Path 15 S-code			Valid mode(s)	PR
	Range	0 ~ 65535	Unit	/	Default	0
	Byte length	16bit	Attribute	R	485 address	0X603F
Please refer to Pr8.28 for S-code setting.						

3.2.10 [Class 9] PR control path parameters

It is more convenient to set Class 9 parameters on Motion Studio

Pr9.00	Label	PR0 mode			Valid mode(s)	PR
	Range	0x0~0xFFFF	Unit	/	Default	0
	Byte length	16bit	Attribute	R/W	485 address	0X6200
Bit	14	8-13	6-7	5	4	0-3
Definition	0: No Jump, indicates with END 1: Jump. Jump to SJ or CJ	0-15: Jump to correspond path	0: absolute 1: correspond command 2: correspond motor	0: No overlap, indicates with SJ 1 Overlap, indicated with CJ	0: Can be Interrupt 1: Can't be Interrupt, indicates using !	0: null 1: Positioning 2: Velocity motion 3: Homing 4: Emergency stop Indicates using P/V/H/S
Pr9.01	Label	PR0 position H			Valid mode(s)	PR
	Range	0~ 0xFFFF	Unit	Pulse	Default	0
	Byte length	16bit	Attribute	R/W	485 address	0X6201
High bit of Path 0 position; (Only valid using 485 communication)						
Pr9.02	Label	PR0 position(L)			Valid mode(s)	PR
	Range	-2147483648~ 2147483647	Unit	Pulse	Default	0
	Byte length	32bit	Attribute	R/W	485 address	0X6202
For Path 0 position, using 485 communication, only able to R/W low 16 bit. R/W high 16 bit needs to be realized through Pr9.02.						
Pr9.03	Label	PR0 velocity			Valid mode(s)	PR
	Range	-10000~10000	Unit	rpm	Default	60
	Byte length	16bit	Attribute	R/W	485 address	0X6203
To set PR path 0 velocity.						
Pr9.04	Label	PR0 acceleration time			Valid mode(s)	PR
	Range	1 ~ 32767	Unit	ms/Krpm	Default	100
	Byte length	16bit	Attribute	R/W	485 address	0X6204
To set PR path 0 acceleration time, time needed for 0rpm to accelerate to 1000rpm						
Pr9.05	Label	PR0 deceleration time			Valid mode(s)	PR
	Range	1 ~32767	Unit	ms/Krpm	Default	100
	Byte length	16bit	Attribute	R/W	485 address	0X6205
To set PR path 0 deceleration time, time needed for 1000rpm to decelerate to 0rpm						
Pr9.06	Label	PR0 pause time			Valid mode(s)	PR
	Range	0 ~ 32767	Unit	ms	Default	0
	Byte length	16bit	Attribute	R/W	485 address	0X6206
To set pause time for PR path 0 from completion to next path						
Pr9.07	Label	PR0 special parameter			Valid mode(s)	PR
	Range	0 ~ 65535	Unit	/	Default	0
	Byte length	16bit	Attribute	R	485 address	0X6207
Reserved						

Pr9.08	Label	PR1 mode			Valid mode(s)	PR														
	Range	0x0~0xFFFF	Unit	/	Default	0														
	Byte length	16bit	Attribute	R/W	485 address	0X6208														
<table border="1"> <thead> <tr> <th>Bit</th> <th>14</th> <th>8-13</th> <th>6-7</th> <th>5</th> <th>4</th> <th>0-3</th> </tr> </thead> <tbody> <tr> <td>Definition</td> <td>0: No Jump, indicates with END 1: Jump. Jump to SJ or CJ</td> <td>0-15: Jump to correspond path</td> <td>0: absolute 1: correspond command 2: correspond motor</td> <td>0: No overlap, indicates with SJ 1 Overlap, indicated with CJ</td> <td>0: Can be Interrupt 1: Can't be Interrupt, indicates using !</td> <td>0: null 1: Positioning 2: Velocity motion 3: Homing 4: Emergency stop Indicates using P/V/H/S</td> </tr> </tbody> </table>							Bit	14	8-13	6-7	5	4	0-3	Definition	0: No Jump, indicates with END 1: Jump. Jump to SJ or CJ	0-15: Jump to correspond path	0: absolute 1: correspond command 2: correspond motor	0: No overlap, indicates with SJ 1 Overlap, indicated with CJ	0: Can be Interrupt 1: Can't be Interrupt, indicates using !	0: null 1: Positioning 2: Velocity motion 3: Homing 4: Emergency stop Indicates using P/V/H/S
Bit	14	8-13	6-7	5	4	0-3														
Definition	0: No Jump, indicates with END 1: Jump. Jump to SJ or CJ	0-15: Jump to correspond path	0: absolute 1: correspond command 2: correspond motor	0: No overlap, indicates with SJ 1 Overlap, indicated with CJ	0: Can be Interrupt 1: Can't be Interrupt, indicates using !	0: null 1: Positioning 2: Velocity motion 3: Homing 4: Emergency stop Indicates using P/V/H/S														
Pr9.09	Label	PR1 position H			Valid mode(s)	PR														
	Range	0~ 0xFFFF	Unit	Pulse	Default	0														
	Byte length	16bit	Attribute	R/W	485 address	0X6209														
High bit of Path 1 position; (Only valid using 485 communication)																				
Pr9.10	Label	PR1 position(L)			Valid mode(s)	PR														
	Range	-2147483648~ 2147483647	Unit	Pulse	Default	0														
	Byte length	32bit	Attribute	R/W	485 address	0X620A														
For Path position, using 485 communication, only able to R/W low 16 bit. R/W high 16 bit needs to be realized through Pr9.09.																				
Pr9.11	Label	PR1 velocity			Valid mode(s)	PR														
	Range	-10000~10000	Unit	rpm	Default	60														
	Byte length	16bit	Attribute	R/W	485 address	0X620B														
To set PR path 1 velocity.																				
Pr9.12	Label	PR1 acceleration time			Valid mode(s)	PR														
	Range	1 ~ 32767	Unit	ms/Krpm	Default	100														
	Byte length	16bit	Attribute	R/W	485 address	0X620C														
To set PR path 1 acceleration time, time needed for 0rpm to accelerate to 1000rpm																				
Pr9.13	Label	PR1 deceleration time			Valid mode(s)	PR														
	Range	1 ~32767	Unit	ms/Krpm	Default	100														
	Byte length	16bit	Attribute	R/W	485 address	0X620D														
To set PR path 1 deceleration time, time needed for 1000rpm to decelerate to 0rpm																				
Pr9.14	Label	PR1 pause time			Valid mode(s)	PR														
	Range	0 ~ 32767	Unit	ms	Default	0														
	Byte length	16bit	Attribute	R/W	485 address	0X620E														
To set pause time for PR path 2 from completion to next path																				
Pr9.15	Label	PR1 special parameter			Valid mode(s)	PR														
	Range	0 ~ 65535	Unit	/	Default	0														
	Byte length	16bit	Attribute	R	485 address	0X620F														
Reserved																				

Pr9.16	Label	PR2 mode			Valid mode(s)	PR														
	Range	0x0~0xFFFF	Unit	/	Default	0														
	Byte length	16bit	Attribute	R/W	485 address	0X6210														
<table border="1"> <thead> <tr> <th>Bit</th> <th>14</th> <th>8-13</th> <th>6-7</th> <th>5</th> <th>4</th> <th>0-3</th> </tr> </thead> <tbody> <tr> <td>Definition</td> <td>0: No Jump, indicates with END 1: Jump. Jump to SJ or CJ</td> <td>0-15: Jump to correspond path</td> <td>0: absolute 1: correspond command 2: correspond motor</td> <td>0: No overlap, indicates with SJ 1 Overlap, indicated with CJ</td> <td>0: Can be Interrupt 1: Can't be Interrupt, indicates using !</td> <td>0: null 1: Positioning 2: Velocity motion 3: Homing 4: Emergency stop Indicates using P/V/H/S</td> </tr> </tbody> </table>							Bit	14	8-13	6-7	5	4	0-3	Definition	0: No Jump, indicates with END 1: Jump. Jump to SJ or CJ	0-15: Jump to correspond path	0: absolute 1: correspond command 2: correspond motor	0: No overlap, indicates with SJ 1 Overlap, indicated with CJ	0: Can be Interrupt 1: Can't be Interrupt, indicates using !	0: null 1: Positioning 2: Velocity motion 3: Homing 4: Emergency stop Indicates using P/V/H/S
Bit	14	8-13	6-7	5	4	0-3														
Definition	0: No Jump, indicates with END 1: Jump. Jump to SJ or CJ	0-15: Jump to correspond path	0: absolute 1: correspond command 2: correspond motor	0: No overlap, indicates with SJ 1 Overlap, indicated with CJ	0: Can be Interrupt 1: Can't be Interrupt, indicates using !	0: null 1: Positioning 2: Velocity motion 3: Homing 4: Emergency stop Indicates using P/V/H/S														
Pr9.17	Label	PR2 position H			Valid mode(s)	PR														
	Range	0~ 0xFFFF	Unit	Pulse	Default	0														
	Byte length	16bit	Attribute	R/W	485 address	0X6211														
High bit of Path 2 position; (Only valid using 485 communication)																				
Pr9.18	Label	PR2 position(L)			Valid mode(s)	PR														
	Range	-2147483648~ 2147483647	Unit	Pulse	Default	0														
	Byte length	32bit	Attribute	R/W	485 address	0X6212														
For Path 2 position, using 485 communication, only able to R/W low 16 bit. R/W high 16 bit needs to be realized through Pr9.17.																				
Pr9.19	Label	PR2 velocity			Valid mode(s)	PR														
	Range	-10000~10000	Unit	rpm	Default	60														
	Byte length	16bit	Attribute	R/W	485 address	0X6213														
To set PR path 2 velocity.																				
Pr9.20	Label	PR2 acceleration time			Valid mode(s)	PR														
	Range	1 ~ 32767	Unit	ms/Krpm	Default	100														
	Byte length	16bit	Attribute	R/W	485 address	0X6214														
To set PR path 2 acceleration time, time needed for 0rpm to accelerate to 1000rpm																				
Pr9.21	Label	PR2 deceleration time			Valid mode(s)	PR														
	Range	1 ~32767	Unit	ms/Krpm	Default	100														
	Byte length	16bit	Attribute	R/W	485 address	0X6215														
To set PR path 2 deceleration time, time needed for 1000rpm to decelerate to 0rpm																				
Pr9.22	Label	PR2 pause time			Valid mode(s)	PR														
	Range	0 ~ 32767	Unit	ms	Default	0														
	Byte length	16bit	Attribute	R/W	485 address	0X6216														
To set pause time for PR path 2 from completion to next path																				
Pr9.23	Label	PR2 special parameter			Valid mode(s)	PR														
	Range	0 ~ 65535	Unit	/	Default	0														
	Byte length	16bit	Attribute	R	485 address	0X6217														
Reserved																				

Pr9.24	Label	PR3 mode			Valid mode(s)	PR
	Range	0x0~0xFFFF	Unit	/	Default	0
	Byte length	16bit	Attribute	R/W	485 address	0X6218
Bit	14	8-13	6-7	5	4	0-3
Definition	0: No Jump, indicates with END 1: Jump. Jump to SJ or CJ	0-15: Jump to correspond path	0: absolute 1: correspond command 2: correspond motor	0: No overlap, indicates with SJ 1 Overlap, indicated with CJ	0: Can be Interrupt 1: Can't be Interrupt, indicates using !	0: null 1: Positioning 2: Velocity motion 3: Homing 4: Emergency stop Indicates using P/V/H/S
Pr9.25	Label	PR3 position H			Valid mode(s)	PR
	Range	0~ 0xFFFF	Unit	Pulse	Default	0
	Byte length	16bit	Attribute	R/W	485 address	0X6219
High bit of Path 3 position; (Only valid using 485 communication)						
Pr9.26	Label	PR3 position(L)			Valid mode(s)	PR
	Range	-2147483648~ 2147483647	Unit	Pulse	Default	0
	Byte length	32bit	Attribute	R/W	485 address	0X621A
For Path 3 position, using 485 communication, only able to R/W low 16 bit. R/W high 16 bit needs to be realized through Pr9.25.						
Pr9.27	Label	PR3 velocity			Valid mode(s)	PR
	Range	-10000~10000	Unit	rpm	Default	60
	Byte length	16bit	Attribute	R/W	485 address	0X621B
To set PR path 3 velocity.						
Pr9.28	Label	PR3 acceleration time			Valid mode(s)	PR
	Range	1 ~ 32767	Unit	ms/Krpm	Default	100
	Byte length	16bit	Attribute	R/W	485 address	0X621C
To set PR path 3 acceleration time, time needed for 0rpm to accelerate to 1000rpm						
Pr9.29	Label	PR3 deceleration time			Valid mode(s)	PR
	Range	1 ~32767	Unit	ms/Krpm	Default	100
	Byte length	16bit	Attribute	R/W	485 address	0X621D
To set PR path 0 deceleration time, time needed for 1000rpm to decelerate to 0rpm						
Pr9.30	Label	PR3 pause time			Valid mode(s)	PR
	Range	0 ~ 32767	Unit	ms	Default	0
	Byte length	16bit	Attribute	R/W	485 address	0X621E
To set pause time for PR path 3 from completion to next path						
Pr9.31	Label	PR3 special parameter			Valid mode(s)	PR
	Range	0 ~ 65535	Unit	/	Default	0
	Byte length	16bit	Attribute	R	485 address	0X621F
Reserved						

Pr9.32	Label	PR4 mode			Valid mode(s)	PR
	Range	0x0~0xFFFF	Unit	/	Default	0
	Byte length	16bit	Attribute	R/W	485 address	0X6220
Bit	14	8-13	6-7	5	4	0-3
Definition	0: No Jump, indicates with END 1: Jump. Jump to SJ or CJ	0-15: Jump to correspond path	0: absolute 1: correspond command 2: correspond motor	0: No overlap, indicates with SJ 1 Overlap, indicated with CJ	0: Can be Interrupt 1: Can't be Interrupt, indicates using !	0: null 1: Positioning 2: Velocity motion 3: Homing 4: Emergency stop Indicates using P/V/H/S
Pr9.33	Label	PR4 position H			Valid mode(s)	PR
	Range	0~ 0xFFFF	Unit	Pulse	Default	0
	Byte length	16bit	Attribute	R/W	485 address	0X6221
High bit of Path 0 position; (Only valid using 485 communication)						
Pr9.34	Label	PR4 position(L)			Valid mode(s)	PR
	Range	-2147483648~ 2147483647	Unit	Pulse	Default	0
	Byte length	32bit	Attribute	R/W	485 address	0X6222
For Path 4 position, using 485 communication, only able to R/W low 16 bit. R/W high 16 bit needs to be realized through Pr9.33.						
Pr9.35	Label	PR4 velocity			Valid mode(s)	PR
	Range	-10000~10000	Unit	rpm	Default	60
	Byte length	16bit	Attribute	R/W	485 address	0X6223
To set PR path 4 velocity.						
Pr9.36	Label	PR0 acceleration time			Valid mode(s)	PR
	Range	1 ~ 32767	Unit	ms/Krpm	Default	100
	Byte length	16bit	Attribute	R/W	485 address	0X6224
To set PR path 4 acceleration time, time needed for 0rpm to accelerate to 1000rpm						
Pr9.37	Label	PR4deceleration time			Valid mode(s)	PR
	Range	1 ~32767	Unit	ms/Krpm	Default	100
	Byte length	16bit	Attribute	R/W	485 address	0X6225
To set PR path 4 deceleration time, time needed for 1000rpm to decelerate to 0rpm						
Pr9.38	Label	PR4 pause time			Valid mode(s)	PR
	Range	0 ~ 32767	Unit	ms	Default	0
	Byte length	16bit	Attribute	R/W	485 address	0X6226
To set pause time for PR path 4 from completion to next path						
Pr9.39	Label	PR4 special parameter			Valid mode(s)	PR
	Range	0 ~ 65535	Unit	/	Default	0
	Byte length	16bit	Attribute	R	485 address	0X6227
Reserved						

Pr9.40	Label	PR5 mode			Valid mode(s)	PR														
	Range	0x0~0xFFFF	Unit	/	Default	0														
	Byte length	16bit	Attribute	R/W	485 address	0X6228														
<table border="1"> <thead> <tr> <th>Bit</th> <th>14</th> <th>8-13</th> <th>6-7</th> <th>5</th> <th>4</th> <th>0-3</th> </tr> </thead> <tbody> <tr> <td>Definition</td> <td>0: No Jump, indicates with END 1: Jump. Jump to SJ or CJ</td> <td>0-15: Jump to correspond path</td> <td>0: absolute 1: correspond command 2: correspond motor</td> <td>0: No overlap, indicates with SJ 1 Overlap, indicated with CJ</td> <td>0: Can be Interrupt 1: Can't be Interrupt, indicates using !</td> <td>0: null 1: Positioning 2: Velocity motion 3: Homing 4: Emergency stop Indicates using P/V/H/S</td> </tr> </tbody> </table>							Bit	14	8-13	6-7	5	4	0-3	Definition	0: No Jump, indicates with END 1: Jump. Jump to SJ or CJ	0-15: Jump to correspond path	0: absolute 1: correspond command 2: correspond motor	0: No overlap, indicates with SJ 1 Overlap, indicated with CJ	0: Can be Interrupt 1: Can't be Interrupt, indicates using !	0: null 1: Positioning 2: Velocity motion 3: Homing 4: Emergency stop Indicates using P/V/H/S
Bit	14	8-13	6-7	5	4	0-3														
Definition	0: No Jump, indicates with END 1: Jump. Jump to SJ or CJ	0-15: Jump to correspond path	0: absolute 1: correspond command 2: correspond motor	0: No overlap, indicates with SJ 1 Overlap, indicated with CJ	0: Can be Interrupt 1: Can't be Interrupt, indicates using !	0: null 1: Positioning 2: Velocity motion 3: Homing 4: Emergency stop Indicates using P/V/H/S														
Pr9.41	Label	PR5 position H			Valid mode(s)	PR														
	Range	0~ 0xFFFF	Unit	Pulse	Default	0														
	Byte length	16bit	Attribute	R/W	485 address	0X6229														
High bit of Path 5 position: (Only valid using 485 communication)																				
Pr9.42	Label	PR5 position(L)			Valid mode(s)	PR														
	Range	-2147483648~ 2147483647	Unit	Pulse	Default	0														
	Byte length	32bit	Attribute	R/W	485 address	0X622A														
For Path 0 position, using 485 communication, only able to R/W low 16 bit. R/W high 16 bit needs to be realized through Pr9.41.																				
Pr9.43	Label	PR5 velocity			Valid mode(s)	PR														
	Range	-10000~10000	Unit	rpm	Default	60														
	Byte length	16bit	Attribute	R/W	485 address	0X622B														
To set PR path 5 velocity.																				
Pr9.44	Label	PR5 acceleration time			Valid mode(s)	PR														
	Range	1 ~ 32767	Unit	ms/Krpm	Default	100														
	Byte length	16bit	Attribute	R/W	485 address	0X622C														
To set PR path 5 acceleration time, time needed for 0rpm to accelerate to 1000rpm																				
Pr9.45	Label	PR5 deceleration time			Valid mode(s)	PR														
	Range	1 ~32767	Unit	ms/Krpm	Default	100														
	Byte length	16bit	Attribute	R/W	485 address	0X622D														
To set PR path 5 deceleration time, time needed for 1000rpm to decelerate to 0rpm																				
Pr9.46	Label	PR5 pause time			Valid mode(s)	PR														
	Range	0 ~ 32767	Unit	ms	Default	0														
	Byte length	16bit	Attribute	R/W	485 address	0X622E														
To set pause time for PR path 5 from completion to next path																				
Pr9.47	Label	PR5 special parameter			Valid mode(s)	PR														
	Range	0 ~ 65535	Unit	/	Default	0														
	Byte length	16bit	Attribute	R	485 address	0X622F														
Reserved																				

Pr9.48	Label	PR6 mode			Valid mode(s)	PR
	Range	0x0~0xFFFF	Unit	/	Default	0
	Byte length	16bit	Attribute	R/W	485 address	0X6230
Bit	14	8-13	6-7	5	4	0-3
Definition	0: No Jump, indicates with END 1: Jump. Jump to SJ or CJ	0-15: Jump to correspond path	0: absolute 1: correspond command 2: correspond motor	0: No overlap, indicates with SJ 1 Overlap, indicated with CJ	0: Can be Interrupt 1: Can't be Interrupt, indicates using !	0: null 1: Positioning 2: Velocity motion 3: Homing 4: Emergency stop Indicates using P/V/H/S
Pr9.49	Label	PR6 position H			Valid mode(s)	PR
	Range	0~ 0xFFFF	Unit	Pulse	Default	0
	Byte length	16bit	Attribute	R/W	485 address	0X6231
High bit of Path 6 position; (Only valid using 485 communication)						
Pr9.50	Label	PR6 position(L)			Valid mode(s)	PR
	Range	-2147483648~ 2147483647	Unit	Pulse	Default	0
	Byte length	32bit	Attribute	R/W	485 address	0X6232
For Path 6 position, using 485 communication, only able to R/W low 16 bit. R/W high 16 bit needs to be realized through Pr9.49.						
Pr9.51	Label	PR6 velocity			Valid mode(s)	PR
	Range	-10000~10000	Unit	rpm	Default	60
	Byte length	16bit	Attribute	R/W	485 address	0X6233
To set PR path 6 velocity.						
Pr9.52	Label	PR6 acceleration time			Valid mode(s)	PR
	Range	1 ~ 32767	Unit	ms/Krpm	Default	100
	Byte length	16bit	Attribute	R/W	485 address	0X6234
To set PR path 6 acceleration time, time needed for 0rpm to accelerate to 1000rpm						
Pr9.53	Label	PR6 deceleration time			Valid mode(s)	PR
	Range	1 ~32767	Unit	ms/Krpm	Default	100
	Byte length	16bit	Attribute	R/W	485 address	0X6235
To set PR path 6 deceleration time, time needed for 1000rpm to decelerate to 0rpm						
Pr9.54	Label	PR6 pause time			Valid mode(s)	PR
	Range	0 ~ 32767	Unit	ms	Default	0
	Byte length	16bit	Attribute	R/W	485 address	0X6236
To set pause time for PR path 6 from completion to next path						
Pr9.55	Label	PR6 special parameter			Valid mode(s)	PR
	Range	0 ~ 65535	Unit	/	Default	0
	Byte length	16bit	Attribute	R	485 address	0X6237
Reserved						

Pr9.56	Label	PR7 mode			Valid mode(s)	PR
	Range	0x0~0xFFFF	Unit	/	Default	0
	Byte length	16bit	Attribute	R/W	485 address	0X6238
Bit	14	8-13	6-7	5	4	0-3
Definition	0: No Jump, indicates with END 1: Jump. Jump to SJ or CJ	0-15: Jump to correspond path	0: absolute 1: correspond command 2: correspond motor	0: No overlap, indicates with SJ 1 Overlap, indicated with CJ	0: Can be Interrupt 1: Can't be Interrupt, indicates using !	0: null 1: Positioning 2: Velocity motion 3: Homing 4: Emergency stop Indicates using P/V/H/S
Pr9.57	Label	PR7 position H			Valid mode(s)	PR
	Range	0~ 0xFFFF	Unit	Pulse	Default	0
	Byte length	16bit	Attribute	R/W	485 address	0X6239
High bit of Path 7 position; (Only valid using 485 communication)						
Pr9.58	Label	PR7 position(L)			Valid mode(s)	PR
	Range	-2147483648~ 2147483647	Unit	Pulse	Default	0
	Byte length	32bit	Attribute	R/W	485 address	0X623A
For Path 7 position, using 485 communication, only able to R/W low 16 bit. R/W high 16 bit needs to be realized through Pr9.57.						
Pr9.59	Label	PR7 velocity			Valid mode(s)	PR
	Range	-10000~10000	Unit	rpm	Default	60
	Byte length	16bit	Attribute	R/W	485 address	0X623B
To set PR path 7 velocity.						
Pr9.60	Label	PR7 acceleration time			Valid mode(s)	PR
	Range	1 ~ 32767	Unit	ms/Krpm	Default	100
	Byte length	16bit	Attribute	R/W	485 address	0X623C
To set PR path 7 acceleration time, time needed for 0rpm to accelerate to 1000rpm						
Pr9.61	Label	PR0 deceleration time			Valid mode(s)	PR
	Range	1 ~32767	Unit	ms/Krpm	Default	100
	Byte length	16bit	Attribute	R/W	485 address	0X623D
To set PR path 0 deceleration time, time needed for 1000rpm to decelerate to 0rpm						
Pr9.62	Label	PR7 pause time			Valid mode(s)	PR
	Range	0 ~ 32767	Unit	ms	Default	0
	Byte length	16bit	Attribute	R/W	485 address	0X623E
To set pause time for PR path 7 from completion to next path						
Pr9.63	Label	PR7 special parameter			Valid mode(s)	PR
	Range	0 ~ 65535	Unit	/	Default	0
	Byte length	16bit	Attribute	R	485 address	0X623F
Reserved						

Pr9.64	Label	PR8 mode			Valid mode(s)	PR
	Range	0x0~0xFFFF	Unit	/	Default	0
	Byte length	16bit	Attribute	R/W	485 address	0X6240
Bit	14	8-13	6-7	5	4	0-3
Definition	0: No Jump, indicates with END 1: Jump. Jump to SJ or CJ	0-15: Jump to correspond path	0: absolute 1: correspond command 2: correspond motor	0: No overlap, indicates with SJ 1 Overlap, indicated with CJ	0: Can be Interrupt 1: Can't be Interrupt, indicates using !	0: null 1: Positioning 2: Velocity motion 3: Homing 4: Emergency stop Indicates using P/V/H/S
Pr9.65	Label	PR8 position H			Valid mode(s)	PR
	Range	0~ 0xFFFF	Unit	Pulse	Default	0
	Byte length	16bit	Attribute	R/W	485 address	0X6241
High bit of Path 0 position; (Only valid using 485 communication)						
Pr9.66	Label	PR8 position(L)			Valid mode(s)	PR
	Range	-2147483648~ 2147483647	Unit	Pulse	Default	0
	Byte length	32bit	Attribute	R/W	485 address	0X6242
For Path 8 position, using 485 communication, only able to R/W low 16 bit. R/W high 16 bit needs to be realized through Pr9.65.						
Pr9.67	Label	PR8 velocity			Valid mode(s)	PR
	Range	-10000~10000	Unit	rpm	Default	60
	Byte length	16bit	Attribute	R/W	485 address	0X6243
To set PR path 8 velocity.						
Pr9.68	Label	PR8 acceleration time			Valid mode(s)	PR
	Range	1 ~ 32767	Unit	ms/Krpm	Default	100
	Byte length	16bit	Attribute	R/W	485 address	0X6244
To set PR path 8 acceleration time, time needed for 0rpm to accelerate to 1000rpm						
Pr9.69	Label	PR8 deceleration time			Valid mode(s)	PR
	Range	1 ~32767	Unit	ms/Krpm	Default	100
	Byte length	16bit	Attribute	R/W	485 address	0X6245
To set PR path 8 deceleration time, time needed for 1000rpm to decelerate to 0rpm						
Pr9.70	Label	PR8 pause time			Valid mode(s)	PR
	Range	0 ~ 32767	Unit	ms	Default	0
	Byte length	16bit	Attribute	R/W	485 address	0X6246
To set pause time for PR path 8 from completion to next path						
Pr9.71	Label	PR8 special parameter			Valid mode(s)	PR
	Range	0 ~ 65535	Unit	/	Default	0
	Byte length	16bit	Attribute	R	485 address	0X6247
Reserved						

Pr9.72	Label	PR9 mode			Valid mode(s)	PR
	Range	0x0~0xFFFF	Unit	/	Default	0
	Byte length	16bit	Attribute	R/W	485 address	0X6248
Bit	14	8-13	6-7	5	4	0-3
Definition	0: No Jump, indicates with END 1: Jump. Jump to SJ or CJ	0-15: Jump to correspond path	0: absolute 1: correspond command 2: correspond motor	0: No overlap, indicates with SJ 1 Overlap, indicated with CJ	0: Can be Interrupt 1: Can't be Interrupt, indicates using !	0: null 1: Positioning 2: Velocity motion 3: Homing 4: Emergency stop Indicates using P/V/H/S
Pr9.73	Label	PR9 position H			Valid mode(s)	PR
	Range	0~ 0xFFFF	Unit	Pulse	Default	0
	Byte length	16bit	Attribute	R/W	485 address	0X6249
High bit of Path 9 position; (Only valid using 485 communication)						
Pr9.74	Label	PR9 position(L)			Valid mode(s)	PR
	Range	-2147483648~ 2147483647	Unit	Pulse	Default	0
	Byte length	32bit	Attribute	R/W	485 address	0X624A
For Path 9 position, using 485 communication, only able to R/W low 16 bit. R/W high 16 bit needs to be realized through Pr9.73.						
Pr9.75	Label	PR0 velocity			Valid mode(s)	PR
	Range	-10000~10000	Unit	rpm	Default	60
	Byte length	16bit	Attribute	R/W	485 address	0X624B
To set PR path 0 velocity.						
Pr9.76	Label	PR9 acceleration time			Valid mode(s)	PR
	Range	1 ~ 32767	Unit	ms/Krpm	Default	100
	Byte length	16bit	Attribute	R/W	485 address	0X624C
To set PR path 9 acceleration time, time needed for 0rpm to accelerate to 1000rpm						
Pr9.77	Label	PR9 deceleration time			Valid mode(s)	PR
	Range	1 ~32767	Unit	ms/Krpm	Default	100
	Byte length	16bit	Attribute	R/W	485 address	0X624D
To set PR path 9 deceleration time, time needed for 1000rpm to decelerate to 0rpm						
Pr9.78	Label	PR9 pause time			Valid mode(s)	PR
	Range	0 ~ 32767	Unit	ms	Default	0
	Byte length	16bit	Attribute	R/W	485 address	0X624E
To set pause time for PR path 9 from completion to next path						
Pr9.79	Label	PR9 special parameter			Valid mode(s)	PR
	Range	0 ~ 65535	Unit	/	Default	0
	Byte length	16bit	Attribute	R	485 address	0X624F
Reserved						

Pr9.80	Label	PR10 mode			Valid mode(s)	PR
	Range	0x0~0xFFFF	Unit	/	Default	0
	Byte length	16bit	Attribute	R/W	485 address	0X6250
Bit	14	8-13	6-7	5	4	0-3
Definition	0: No Jump, indicates with END 1: Jump. Jump to SJ or CJ	0-15: Jump to correspond path	0: absolute 1: correspond command 2: correspond motor	0: No overlap, indicates with SJ 1 Overlap, indicated with CJ	0: Can be Interrupt 1: Can't be Interrupt, indicates using !	0: null 1: Positioning 2: Velocity motion 3: Homing 4: Emergency stop Indicates using P/V/H/S
Pr9.81	Label	PR10 position H			Valid mode(s)	PR
	Range	0~ 0xFFFF	Unit	Pulse	Default	0
	Byte length	16bit	Attribute	R/W	485 address	0X6251
High bit of Path10 position: (Only valid using 485 communication)						
Pr9.82	Label	PR10 position(L)			Valid mode(s)	PR
	Range	-2147483648~ 2147483647	Unit	Pulse	Default	0
	Byte length	32bit	Attribute	R/W	485 address	0X6252
For Path 10 position, using 485 communication, only able to R/W low 16 bit. R/W high 16 bit needs to be realized through Pr9.81.						
Pr9.83	Label	PR10 velocity			Valid mode(s)	PR
	Range	-10000~10000	Unit	rpm	Default	60
	Byte length	16bit	Attribute	R/W	485 address	0X6253
To set PR path 10 velocity.						
Pr9.84	Label	PR10 acceleration time			Valid mode(s)	PR
	Range	1 ~ 32767	Unit	ms/Krpm	Default	100
	Byte length	16bit	Attribute	R/W	485 address	0X6254
To set PR path 10 acceleration time, time needed for 0rpm to accelerate to 1000rpm						
Pr9.85	Label	PR10 deceleration time			Valid mode(s)	PR
	Range	1 ~32767	Unit	ms/Krpm	Default	100
	Byte length	16bit	Attribute	R/W	485 address	0X6255
To set PR path 10 deceleration time, time needed for 1000rpm to decelerate to 0rpm						
Pr9.86	Label	PR10 pause time			Valid mode(s)	PR
	Range	0 ~ 32767	Unit	ms	Default	0
	Byte length	16bit	Attribute	R/W	485 address	0X6256
To set pause time for PR path 10 from completion to next path						
Pr9.87	Label	PR10 special parameter			Valid mode(s)	PR
	Range	0 ~ 65535	Unit	/	Default	0
	Byte length	16bit	Attribute	R	485 address	0X6257
Reserved						

Pr9.88	Label	PR11 mode			Valid mode(s)	PR
	Range	0x0~0xFFFF	Unit	/	Default	0
	Byte length	16bit	Attribute	R/W	485 address	0X6258
Bit	14	8-13	6-7	5	4	0-3
Definition	0: No Jump, indicates with END 1: Jump. Jump to SJ or CJ	0-15: Jump to correspond path	0: absolute 1: correspond command 2: correspond motor	0: No overlap, indicates with SJ 1 Overlap, indicated with CJ	0: Can be Interrupt 1: Can't be Interrupt, indicates using !	0: null 1: Positioning 2: Velocity motion 3: Homing 4: Emergency stop Indicates using P/V/H/S
Pr9.89	Label	PR11 position H			Valid mode(s)	PR
	Range	0~ 0xFFFF	Unit	Pulse	Default	0
	Byte length	16bit	Attribute	R/W	485 address	0X6259
High bit of Path 11 position; (Only valid using 485 communication)						
Pr9.90	Label	PR11 position(L)			Valid mode(s)	PR
	Range	-2147483648~ 2147483647	Unit	Pulse	Default	0
	Byte length	32bit	Attribute	R/W	485 address	0X625A
For Path 11 position, using 485 communication, only able to R/W low 16 bit. R/W high 16 bit needs to be realized through Pr9.89.						
Pr9.91	Label	PR11 velocity			Valid mode(s)	PR
	Range	-10000~10000	Unit	rpm	Default	60
	Byte length	16bit	Attribute	R/W	485 address	0X625B
To set PR path 11 velocity.						
Pr9.92	Label	PR11 acceleration time			Valid mode(s)	PR
	Range	1 ~ 32767	Unit	ms/Krpm	Default	100
	Byte length	16bit	Attribute	R/W	485 address	0X625C
To set PR path 11 acceleration time, time needed for 0rpm to accelerate to 1000rpm						
Pr9.93	Label	PR11 deceleration time			Valid mode(s)	PR
	Range	1 ~32767	Unit	ms/Krpm	Default	100
	Byte length	16bit	Attribute	R/W	485 address	0X625D
To set PR path 11 deceleration time, time needed for 1000rpm to decelerate to 0rpm						
Pr9.94	Label	PR11 pause time			Valid mode(s)	PR
	Range	0 ~ 32767	Unit	ms	Default	0
	Byte length	16bit	Attribute	R/W	485 address	0X625E
To set pause time for PR path 11 from completion to next path						
Pr9.95	Label	PR11 special parameter			Valid mode(s)	PR
	Range	0 ~ 65535	Unit	/	Default	0
	Byte length	16bit	Attribute	R	485 address	0X625F
Reserved						

Pr9.96	Label	PR12 mode			Valid mode(s)	PR
	Range	0x0~0xFFFF	Unit	/	Default	0
	Byte length	16bit	Attribute	R/W	485 address	0X6260
Bit	14	8-13	6-7	5	4	0-3
Definition	0: No Jump, indicates with END 1: Jump. Jump to SJ or CJ	0-15: Jump to correspond path	0: absolute 1: correspond command 2: correspond motor	0: No overlap, indicates with SJ 1 Overlap, indicated with CJ	0: Can be Interrupt 1: Can't be Interrupt, indicates using !	0: null 1: Positioning 2: Velocity motion 3: Homing 4: Emergency stop Indicates using P/V/H/S
Pr9.97	Label	PR12 position H			Valid mode(s)	PR
	Range	0~ 0xFFFF	Unit	Pulse	Default	0
	Byte length	16bit	Attribute	R/W	485 address	0X6261
High bit of Path 12 position; (Only valid using 485 communication)						
Pr9.98	Label	PR12 position(L)			Valid mode(s)	PR
	Range	-2147483648~ 2147483647	Unit	Pulse	Default	0
	Byte length	32bit	Attribute	R/W	485 address	0X6262
For Path 12 position, using 485 communication, only able to R/W low 16 bit. R/W high 16 bit needs to be realized through Pr9.97.						
Pr9.99	Label	PR12 velocity			Valid mode(s)	PR
	Range	-10000~10000	Unit	rpm	Default	60
	Byte length	16bit	Attribute	R/W	485 address	0X6263
To set PR path 12 velocity.						
Pr9.100	Label	PR12 acceleration time			Valid mode(s)	PR
	Range	1 ~ 32767	Unit	ms/Krpm	Default	100
	Byte length	16bit	Attribute	R/W	485 address	0X6264
To set PR path 12 acceleration time, time needed for 0rpm to accelerate to 1000rpm						
Pr9.101	Label	PR12 deceleration time			Valid mode(s)	PR
	Range	1 ~32767	Unit	ms/Krpm	Default	100
	Byte length	16bit	Attribute	R/W	485 address	0X6265
To set PR path 12 deceleration time, time needed for 1000rpm to decelerate to 0rpm						
Pr9.102	Label	PR12 pause time			Valid mode(s)	PR
	Range	0 ~ 32767	Unit	ms	Default	0
	Byte length	16bit	Attribute	R/W	485 address	0X6266
To set pause time for PR path 12 from completion to next path						
Pr9.103	Label	PR12 special parameter			Valid mode(s)	PR
	Range	0 ~ 65535	Unit	/	Default	0
	Byte length	16bit	Attribute	R	485 address	0X6267
Reserved						

Pr9.104	Label	PR13 mode			Valid mode(s)	PR
	Range	0x0~0xFFFF	Unit	/	Default	0
	Byte length	16bit	Attribute	R/W	485 address	0X6268
Bit	14	8-13	6-7	5	4	0-3
Definition	0: No Jump, indicates with END 1: Jump. Jump to SJ or CJ	0-15: Jump to correspond path	0: absolute 1: correspond command 2: correspond motor	0: No overlap, indicates with SJ 1 Overlap, indicated with CJ	0: Can be Interrupt 1: Can't be Interrupt, indicates using !	0: null 1: Positioning 2: Velocity motion 3: Homing 4: Emergency stop Indicates using P/V/H/S
Pr9.105	Label	PR13 position H			Valid mode(s)	PR
	Range	0~ 0xFFFF	Unit	Pulse	Default	0
	Byte length	16bit	Attribute	R/W	485 address	0X6269
High bit of Path 13 position; (Only valid using 485 communication)						
Pr9.106	Label	PR13 position(L)			Valid mode(s)	PR
	Range	-2147483648~ 2147483647	Unit	Pulse	Default	0
	Byte length	32bit	Attribute	R/W	485 address	0X626A
For Path 13 position, using 485 communication, only able to R/W low 16 bit. R/W high 16 bit needs to be realized through Pr9.105.						
Pr9.107	Label	PR13 velocity			Valid mode(s)	PR
	Range	-10000~10000	Unit	rpm	Default	60
	Byte length	16bit	Attribute	R/W	485 address	0X626B
To set PR path 13 velocity.						
Pr9.108	Label	PR13 acceleration time			Valid mode(s)	PR
	Range	1 ~ 32767	Unit	ms/Krpm	Default	100
	Byte length	16bit	Attribute	R/W	485 address	0X626C
To set PR path 13 acceleration time, time needed for 0rpm to accelerate to 1000rpm						
Pr9.109	Label	PR13 deceleration time			Valid mode(s)	PR
	Range	1 ~32767	Unit	ms/Krpm	Default	100
	Byte length	16bit	Attribute	R/W	485 address	0X626D
To set PR path 13 deceleration time, time needed for 1000rpm to decelerate to 0rpm						
Pr9.110	Label	PR13 pause time			Valid mode(s)	PR
	Range	0 ~ 32767	Unit	ms	Default	0
	Byte length	16bit	Attribute	R/W	485 address	0X626E
To set pause time for PR path 13 from completion to next path						
Pr9.111	Label	PR13 special parameter			Valid mode(s)	PR
	Range	0 ~ 65535	Unit	/	Default	0
	Byte length	16bit	Attribute	R	485 address	0X626F
Reserved						

Pr9.112	Label	PR14 mode			Valid mode(s)	PR
	Range	0x0~0xFFFF	Unit	/	Default	0
	Byte length	16bit	Attribute	R/W	485 address	0X6270
Bit	14	8-13	6-7	5	4	0-3
Definition	0: No Jump, indicates with END 1: Jump. Jump to SJ or CJ	0-15: Jump to correspond path	0: absolute 1: correspond command 2: correspond motor	0: No overlap, indicates with SJ 1 Overlap, indicated with CJ	0: Can be Interrupt 1: Can't be Interrupt, indicates using !	0: null 1: Positioning 2: Velocity motion 3: Homing 4: Emergency stop Indicates using P/V/H/S
Pr9.113	Label	PR14 position H			Valid mode(s)	PR
	Range	0~ 0xFFFF	Unit	Pulse	Default	0
	Byte length	16bit	Attribute	R/W	485 address	0X6271
High bit of Path 14 position; (Only valid using 485 communication)						
Pr9.114	Label	PR14 position(L)			Valid mode(s)	PR
	Range	-2147483648~ 2147483647	Unit	Pulse	Default	0
	Byte length	32bit	Attribute	R/W	485 address	0X6272
For Path 14 position, using 485 communication, only able to R/W low 16 bit. R/W high 16 bit needs to be realized through Pr9.113.						
Pr9.115	Label	PR14 velocity			Valid mode(s)	PR
	Range	-10000~10000	Unit	rpm	Default	60
	Byte length	16bit	Attribute	R/W	485 address	0X6273
To set PR path 14 velocity.						
Pr9.116	Label	PR14 acceleration time			Valid mode(s)	PR
	Range	1 ~ 32767	Unit	ms/Krpm	Default	100
	Byte length	16bit	Attribute	R/W	485 address	0X6274
To set PR path 14 acceleration time, time needed for 0rpm to accelerate to 1000rpm						
Pr9.117	Label	PR14 deceleration time			Valid mode(s)	PR
	Range	1 ~32767	Unit	ms/Krpm	Default	100
	Byte length	16bit	Attribute	R/W	485 address	0X6275
To set PR path 14 deceleration time, time needed for 1000rpm to decelerate to 0rpm						
Pr9.118	Label	PR14 pause time			Valid mode(s)	PR
	Range	0 ~ 32767	Unit	ms	Default	0
	Byte length	16bit	Attribute	R/W	485 address	0X6276
To set pause time for PR path 14 from completion to next path						
Pr9.119	Label	PR14 special parameter			Valid mode(s)	PR
	Range	0 ~ 65535	Unit	/	Default	0
	Byte length	16bit	Attribute	R	485 address	0X6277
Reserved						

Pr9.120	Label	PR15 mode			Valid mode(s)	PR
	Range	0x0~0xFFFF	Unit	/	Default	0
	Byte length	16bit	Attribute	R/W	485 address	0X6278
Bit	14	8-13	6-7	5	4	0-3
Definition	0: No Jump, indicates with END 1: Jump. Jump to SJ or CJ	0-15: Jump to correspond path	0: absolute 1: correspond command 2: correspond motor	0: No overlap, indicates with SJ 1 Overlap, indicated with CJ	0: Can be Interrupt 1: Can't be Interrupt, indicates using !	0: null 1: Positioning 2: Velocity motion 3: Homing 4: Emergency stop Indicates using P/V/H/S
Pr9.121	Label	PR15 position H			Valid mode(s)	PR
	Range	0~ 0xFFFF	Unit	Pulse	Default	0
	Byte length	16bit	Attribute	R/W	485 address	0X6279
High bit of Path 15 position; (Only valid using 485 communication)						
Pr9.122	Label	PR15 position(L)			Valid mode(s)	PR
	Range	-2147483648~ 2147483647	Unit	Pulse	Default	0
	Byte length	32bit	Attribute	R/W	485 address	0X627A
For Path 15 position, using 485 communication, only able to R/W low 16 bit. R/W high 16 bit needs to be realized through Pr9.121.						
Pr9.123	Label	PR15 velocity			Valid mode(s)	PR
	Range	-10000~10000	Unit	rpm	Default	60
	Byte length	16bit	Attribute	R/W	485 address	0X627B
To set PR path 15 velocity.						
Pr9.124	Label	PR15 acceleration time			Valid mode(s)	PR
	Range	1 ~ 32767	Unit	ms/Krpm	Default	100
	Byte length	16bit	Attribute	R/W	485 address	0X627C
To set PR path 15 acceleration time, time needed for 0rpm to accelerate to 1000rpm						
Pr9.125	Label	PR15 deceleration time			Valid mode(s)	PR
	Range	1 ~32767	Unit	ms/Krpm	Default	100
	Byte length	16bit	Attribute	R/W	485 address	0X627D
To set PR path 15 deceleration time, time needed for 1000rpm to decelerate to 0rpm						
Pr9.126	Label	PR15 pause time			Valid mode(s)	PR
	Range	0 ~ 32767	Unit	ms	Default	0
	Byte length	16bit	Attribute	R/W	485 address	0X627E
To set pause time for PR path 15 from completion to next path						
Pr9.127	Label	PR15 special parameter			Valid mode(s)	PR
	Range	0 ~ 65535	Unit	/	Default	0
	Byte length	16bit	Attribute	R	485 address	0X627F
Reserved						

3.2.11 [Class B] Status Parameters

PrB.00	Label	Software version 1 (DSP)			Valid mode(s)	P	S	T
	Range	/	Unit	/	Default	/		
	Byte length	16bit	Attribute	R	485 address	0x0B00		
Show DSP software version info.								
PrB.01	Label	Software version 2 (CPLD)			Valid mode(s)	P	S	T
	Range	/	Unit	/	Default	/		
	Byte length	16bit	Attribute	R	485 address	0x0B01		
Show software version info.								
PrB.02	Label	Software version 3 (Others)			Valid mode(s)	P	S	T
	Range	/	Unit	/	Default	/		
	Byte length	16bit	Attribute	R	485 address	0x0B02		
Show software version info.								
PrB.03	Label	Current alarm			Valid mode(s)	P	S	T
	Range	/	Unit	/	Default	/		
	Byte length	16bit	Attribute	R	485 address	0x0B03		
Show current alarm								
PrB.04	Label	Motor not rotating cause			Valid mode(s)	P	S	T
	Range	/	Unit	/	Default	/		
	Byte length	16bit	Attribute	R	485 address	0x0B04		
Show cause of motor not rotating								
PrB.05	Label	Driver operation status			Valid mode(s)	P	S	T
	Range	/	Unit	/	Default	/		
	Byte length	16bit	Attribute	R	485 address	0x0B05		
	Bit	Status	Description					
	0	RDY	Servo is ready					
	1	RUN	Servo is running					
	2	ERR	Driver error					
	3	HOME_OK	Homing completed					
	4	INP	In position					
	5	AT-SPEED	Velocity reached					
	6~15		Reserved					
PrB.06	Label	Motor speed (Before filter)			Valid mode(s)	P	S	T
	Range	/	Unit	rpm	Default	/		
	Byte length	16bit	Attribute	R	485 address	0x0B06		
Motor actual speed								
PrB.07	Label	Motor torque			Valid mode(s)	P	S	T
	Range	/	Unit	%	Default	/		
	Byte length	16bit	Attribute	R	485 address	0x0B07		
The percentage of motor actual torque and rated torque								
PrB.08	Label	Motor current			Valid mode(s)	P	S	T
	Range	/	Unit	0.01A	Default	/		
	Byte length	16bit	Attribute	R	485 address	0x0B08		
Motor actual current								

PrB.09	Label	Motor speed (After filter)			Valid mode(s)	P	S	T
	Range	/	Unit	rpm	Default	/		
	Byte length	16bit	Attribute	R	485 address	0x0B09		
Motor speed after motor actual speed filtering								

PrB.10	Label	DC bus voltage			Valid mode(s)	P	S	T
	Range	/	Unit	V	Default	/		
	Byte length	16bit	Attribute	R	485 address	0x0B0A		
Driver DC bus actual voltage								

PrB.11	Label	Driver temperature			Valid mode(s)	P	S	T
	Range	/	Unit	°C	Default	/		
	Byte length	16bit	Attribute	R	485 address	0x0B0B		
Actual driver temperature								

PrB.12	Label	External analog 1			Valid mode(s)	P	S	T
	Range	/	Unit	0.01V	Default	/		
	Byte length	16bit	Attribute	R	485 address	0x0B0C		
Driver analog input 1								

PrB.13	Label	External analog 2			Valid mode(s)	P	S	T
	Range	/	Unit	0.01V	Default	/		
	Byte length	16bit	Attribute	R	485 address	0x0B0D		
Driver analog input 2								

PrB.14	Label	External analog 3			Valid mode(s)	P	S	T
	Range	/	Unit	0.01V	Default	/		
	Byte length	16bit	Attribute	R	485 address	0x0B0E		
Driver analog input 3								

PrB.15	Label	Motor overload rate			Valid mode(s)	P	S	T
	Range	/	Unit	%	Default	/		
	Byte length	16bit	Attribute	R	485 address	0x0B0F		
Motor overload rate								

PrB.16	Label	Vent overload rate			Valid mode(s)	P	S	T
	Range	/	Unit	%	Default	/		
	Byte length	16bit	Attribute	R	485 address	0x0B10		
Vent overload rate								

PrB.17	Label	Physical I/O input status			Valid mode(s)	P	S	T
	Range	/	Unit	/	Default	/		
	Byte length	16bit	Attribute	R	485 address	0x0B04		
Driver physical I/O input bit0 corresponds to DI1, bit1 to DI2 and so on; Bitn=1, DI _{n+1} high level signal input; Bitn=0, DI _{n+1} low level signal input								

PrB.18	Label	Cause of motor not rotating			Valid mode(s)	P	S	T
	Range	/	Unit	/	Default	/		
	Byte length	16bit	Attribute	R	485 address	0x0B04		
Driver physical I/O output bit0 corresponds to DO1, bit1 to DO2 and so on; Bitn=1, DO _{n+1} high level signal output; Bitn=0 indicates DO _{n+1} low level signal output								

PrB.20	Label	Command position (Command unit)			Valid mode(s)	P		
	Range	/	Unit	P	Default	/		
	Byte length	32bit	Attribute	R	485 address	H: 0x0B14 L: 0x0B15		
Driver receives command pulse count. Driver command unit: 10000 pulses/rev, Encoder unit: 8388608 pulses/rev. If driver receives 8388608 pulses, 10000P will be shown.								

PrB.21	Label	Motor position (Command unit)			Valid mode(s)	P		
	Range	/	Unit	P	Default	/		
	Byte length	32bit	Attribute	R	485 address	H: 0x0B16 L: 0x0B17		
Motor position feedback. Driver command unit: 10000 pulses/rev, Encoder unit: 8388608 pulses/rev. If driver receives 8388608 pulses, 10000P will be shown.								

PrB.22	Label	Position deviation (Command unit)			Valid mode(s)	P		
	Range	/	Unit	P	Default	/		
	Byte length	32bit	Attribute	R	485 address	H: 0x0B18 L: 0x0B19		
Shows position deviation. Please refer to PrB.20.								

PrB.23	Label	Command position (Encoder unit)			Valid mode(s)	P		
	Range	/	Unit	P	Default	/		
	Byte length	32bit	Attribute	R	485 address	H: 0x0B1A L: 0x0B1B		
Driver receives command pulse count. Driver command unit: 10000 pulses/rev, Encoder unit: 8388608 pulses/rev. If driver receives 10000 pulses, 8388608 pulses will be shown.								

PrB.24	Label	Motor position (Encoder unit)			Valid mode(s)	P		
	Range	/	Unit	P	Default	/		
	Byte length	32bit	Attribute	R	485 address	H: 0x0B1C L: 0x0B1D		
Driver receives motor encoder feedback pulses								

PrB.25	Label	Position deviation (Encoder unit)			Valid mode(s)	P		
	Range	/	Unit	P	Default	/		
	Byte length	32bit	Attribute	R	485 address	H: 0x0B1E L: 0x0B1F		
Shows position deviation. Please refer to PrB.23.								

PrB.26	Label	Rotational encoder position feedback (Command unit)			Valid mode(s)	P		
	Range	/	Unit	P	Default	/		
	Byte length	32bit	Attribute	R	485 address	H: 0x0B20 L: 0x0B21		
Motor position under rotary mode. Please refer to PrB.21								

Chapter 4 Control Mode

Control modes for ELD2-RS series DC servo drives can be divided into 3 categories: Position control mode, Velocity control mode and Torque control mode. RS models also come with a hybrid control mode which is a combination of any 2 modes which are above.

- Position control mode determines position through pulse count. External input pulse frequency determines rotational speed, mainly through motion controller, control card (5V pulse), PLC (24V pulse). Due to the ability of position control mode to control velocity and position tightly, it is usually use in positioning devices. It is the most widely used control mode for servo drives.
- Velocity control mode controls rotational speed through digital I/O or communication command settings. Mainly use in application where speed stability is required.
- Torque control mode is used in applications where forced applied on production material is restricted, mainly winding or scrolling devices. For example, coil winding machines or optical fiber cable production. Torque settings change according to the coil winding diameter as to maintain stable force output throughout the process.

To set control mode

Pr0.01 *	Label	Control Mode Settings			Valid mode(s)	P	S	T
	Range	0~10	Unit	—	Default	0		
	Byte length	16bit	Attribute	R/W	485 address	0x0003		
	Valid	After restart						

Value	Description	
	1 st mode	2 nd mode
【0】	Position	—
1	Velocity	—
2	Torque	—
3	Position	Velocity
4	Position	Torque
5	Velocity	Torque
6	PR internal command control	Position Pr0.22=1
		Velocity Pr0.22=1
		Torque Pr0.22=2
7~10	Reserved	

◆When 3, 4, 5, 6 combination hybrid mode, 1st and 2nd mode can be chosen accordingly with control mode switching input (C-MODE).
 C-MODE: Invalid, select 1st mode.
 C-MODE: Valid, select 2st mode.
 Please allow some time in between mode switching commands.
 ◆Please set Pr0.01 = 6 to switch to other modes from PR mod, then set 2nd mode using Pr0.22.
C-MODE is defaulted to Normally Open

4.1 Position control

Position control determines rotational speed by frequency of external input pulse and angle of rotation through pulse count using 5V pulse from motion controller, control card or 24V pulse (Please add 2k Ω resistor) for PLC. Applies where precise positioning is required.

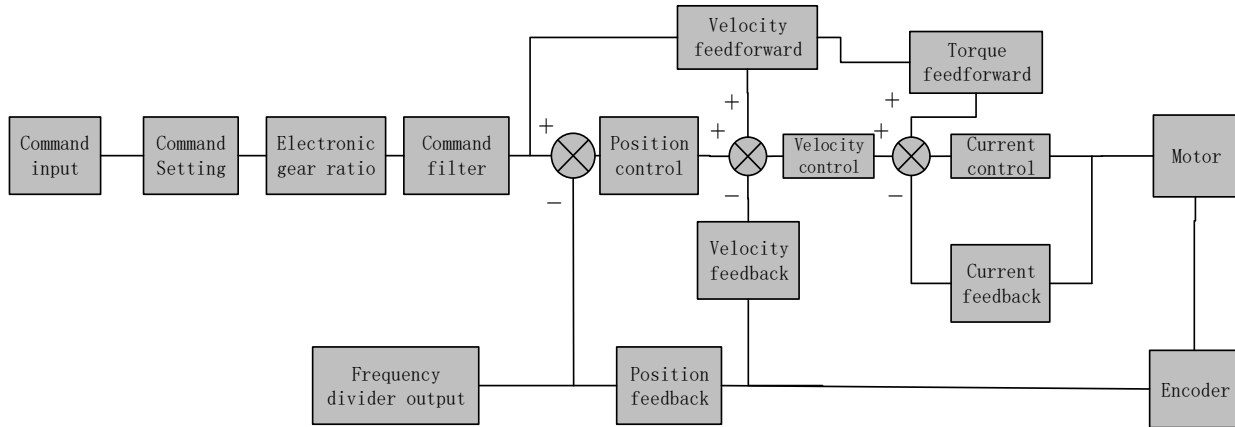

Set Pr0.01 = 0 to activate position control mode.

Please set related servo parameters according with the following diagram.

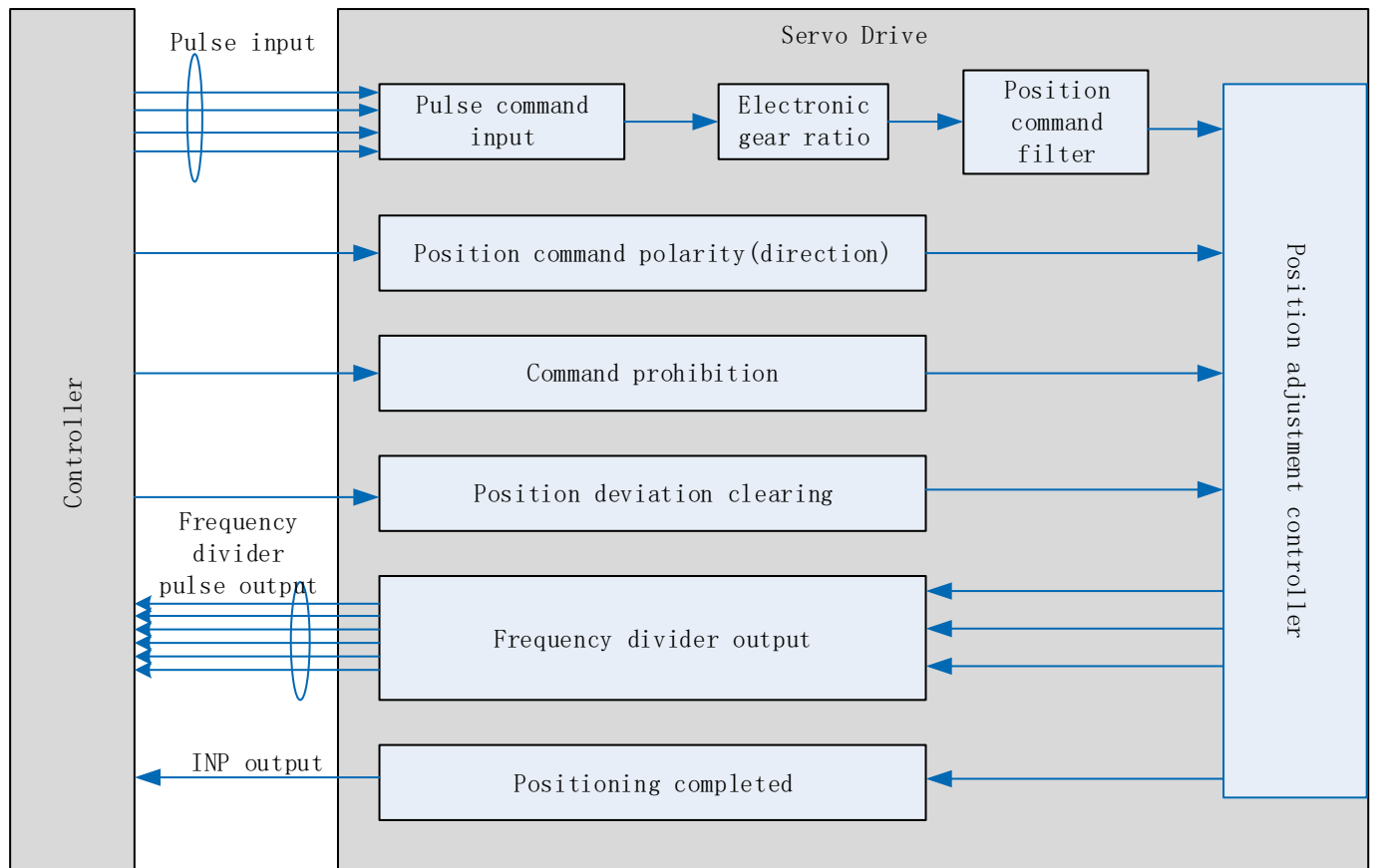

4.1.1 Pulse input and direction settings

Position command (pulse) input method:

1. A and B phase pulse
2. Positive/Negative direction pulse
3. Pulse count + symbol

Set pulse mode, rotational direction and max. pulse input frequency according to actual need

CN1 Pin	Label	Definition	Description
1/15	DI1+	Pulse command input	Low speed pulse direction command input: PUL+ / PUL-: 5V differential input (500KHz) DIR+ / DIR-: 5V differential input (500KHz)
2/16	DI1-		
3/17	DI2+	Direction command input	
4/18	DI2-		

Pr0.06	Label	Command pulse polarity inversion			Valid mode(s)	P		
	Range	0~1	Unit	—	Default	0		
	Byte length	16bit	Attribute	R/W	485 address	0x000D		
	Valid	After restart						
Pr0.06 and Pr0.07 set command pulse input inversion and mode correspondingly.								

Pr0.07	Label	Command pulse input mode			Valid mode(s)	P		
	Range	0~3	Unit	—	Default	3		
	Byte length	16bit	Attribute	R/W	485 address	0x000F		
	Valid	After restart						

Command pulse input

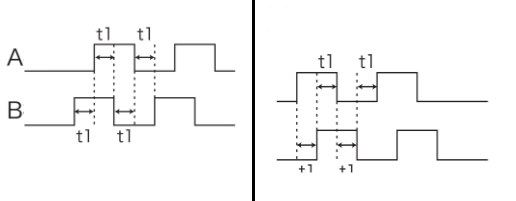
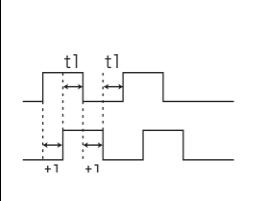
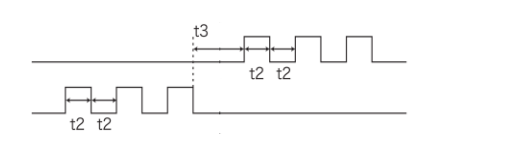
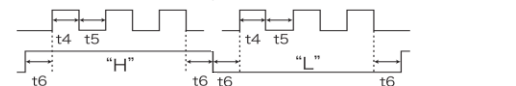
Command Polarity inversion (Pr0.06)	Command pulse input mode settings (Pr0.07)	Command Pulse Mode	Positive signal	Negative signal
【0】	0 or 2	90° phase difference 2 phase pulse (Phase A+ Phase B)		
	1	CW pulse sequence + CCW pulse sequence		
	【3】	Pulse sequence + Directional symbol		

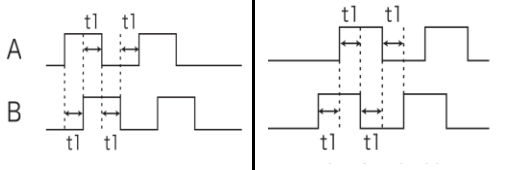
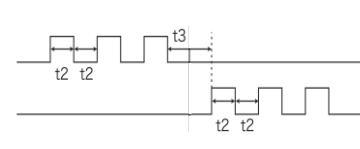
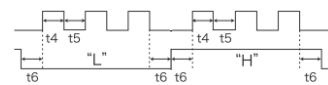
1	0 or 2	90° phase difference 2 phase pulse (Phase A + Phase B)	
	1	CW pulse sequence + CCW pulse sequence	
	3	Pulse sequence + Directional symbol	

4.1.2 Electronic Gear Ratio

To realize correspondent motor rotational angle to arbitrarily set input command input by multiplying pulse command input from controller and coefficient of frequency divider/multiplier. Motor might not reach target velocity due to insufficient pulse output from controller. This function can be used to solve this issue by increasing pulse command frequency.

1. When Pr0.08 = 0, Pr0.09 and Pr0.10 will be valid. Other than that, Pr0.08 set value will be valid.
2. ELD2-RS series supports 2 independent sets of electronic gear ratio. The 2 sets can be switch by delivering a command frequency divider/multiplier input DIV1. Both sets of electronic gear ratio is set up using Pr0.08, Pr0.09 and Pr0.10; Pr5.00, Pr5.01 and Pr5.02.

Pr0.08	Label	1st command pulse count per revolution			Valid mode(s)	P	S	T
	Range	0-67100864	Unit	PULSE	Default	10000		
	Byte length	32bit	Attribute	R/W	485 address	H: 0x0010 L: 0x0011		
	Valid	After restart						
Control will affected if value set is too low. Err1b1 might occur if value < 500. (1) Pr0.08 valid when ≠ 0: Motor revolution = input pulse count / [Pr0.08 value] (2) Pr0.08 invalid when = 0: Pr0.09 and Pr0.10 valid.								
Pr0.09	Label	1st command frequency divider/multiplier numerator			Valid mode(s)	P		
	Range	1~2147483647	Unit	—	Default	1		
	Byte length	32bit	Attribute	R/W	485 address	H: 0x0012 L: 0x0013		
	Valid	After restart						
Valid when Pr0.08 = 0, please refer to description in Pr0.10.								
Pr0.10	Label	1st command frequency divider/multiplier denominator			Valid mode(s)	P		
	Range	1~2147483647	Unit	—	Default	1		
	Byte length	32bit	Attribute	R/W	485 address	H: 0x0014 L: 0x0015		
	Valid	After restart						

1. Settings:
 (1) Driver command pulse input count : X
 (2) Encoder pulse count after frequency divider/multiplier: Y
 (3) Encoder pulse count per revolution: Z
 (4) Motor revolution: W

2. Calculation:
 (1) X, Y
 $Y = X * Pr0.09 / Pr0.10$
 Please keep the value of Pr0.09 and Pr0.10 to be smaller than 2^{24} (16777216).
 (2) Z
 Motor with 17-bit motor: $Z = 2^{17} = 131072$
 (3) Y, Z, W
 $W = Y / Z$
Performance cannot be guaranteed if frequency divider/multiplier ratio is set to extreme values. Err1b1 might occur if $W < 500$.

4.1.3 Position command filter

Position command filter is to filter position command after electronic gear ratio frequency dividing/multiplying. Including position command smoothing filter and position command FIR filter.

Position command filter should be added for the following cases:

1. Position command pulse from controller has not yet to undergo acceleration/deceleration (with steep acceleration/deceleration).
2. Low command pulse frequency
3. Electronic gear ratio = 10 times or above

Position command filter can smoothen position command and motor rotation will be more stable

Pr2.22	Label	Position command smoothing filter			Valid mode(s)	P	
	Range	0~32767	Unit	0.1ms	Default	0	
	Byte length	16bit	Attribute	R/W	485 address	0x022D	
	Valid	At stop					

To set time constant of 1 time delay filter of position command.

To set time constant of 1 time delay filter, according to target velocity V_c square wave command as show below.

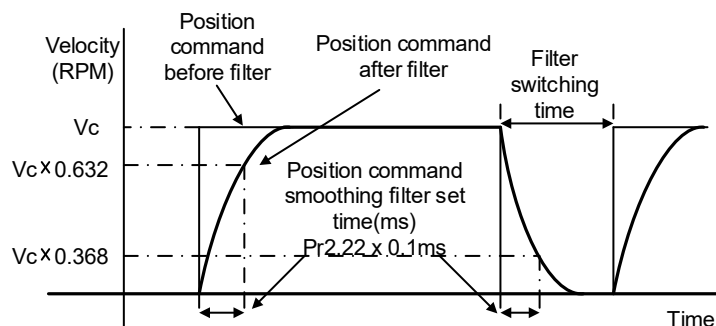

Usually applied when there is rather sharp acceleration which might cause motor overshoot or undershoot. To smoothen command signal, reduces impact to machines and eliminate vibration. If Pr2.22 is set too high, overall time will be lengthened.

Pr2.23	Label	Position command FIR filter		Valid mode(s)	P	
	Range	0~2500	Unit	0.1ms	Default	0
	Byte length	16bit	Attribute	R/W	485 address	0x022F
	Valid	At stop				

As shown below, when target velocity V_c square wave command reaches V_c , it becomes trapezoidal wave after filtering.

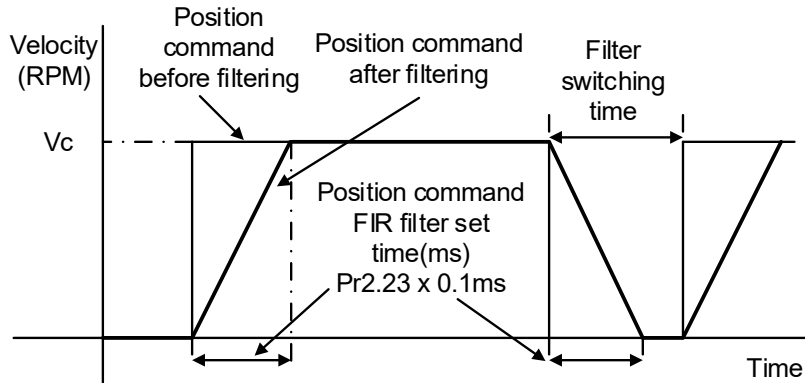

As shown below, when target velocity V_c trapezoidal command reaches V_c , it becomes S wave after filtering.

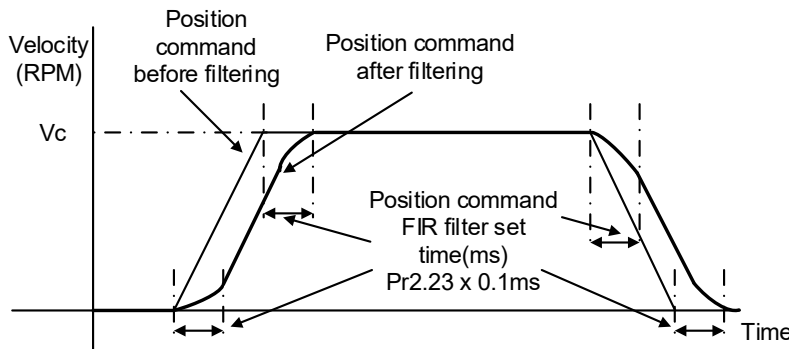









Usually applied when there is rather sharp acceleration which might cause motor overshoot or undershoot. To smoothen command signal, reduces impact to machines and eliminate vibration. If Pr2.23 is set too high, overall time will be lengthened.

Note: Please wait for command to stop and after filter idle time to modify Pr2.23.

$$\text{Filter switching time} = (\text{Pr2.23 set value} \times 0.1\text{ms} + 0.25\text{ms})$$

4.1.4 Encoder feedback output

Motor position feedback of A, B phase to master device (controller) in pulse

Pr0.11	Label	Encoder output pulse count per revolution			Valid mode(s)	P	S	T
	Range	1~32767	Unit	P/r	Default	2500		
	Byte length	16bit	Attribute	R/W	485 address	0x0017		
	Valid	After restart						
If Pr0.11 = 1000, encoder differential output signal per revolution = 4000 pulses								
Pr0.12	Label	Pulse output logic inversion			Valid mode(s)	P	S	T
	Range	0~1	Unit	—	Default	0		
	Byte length	16bit	Attribute	R/W	485 address	0x0019		
	Valid	After restart						
To set phase B logic and output source from encoder pulse output. To inverse B-Phase pulse logic and change the relation between Phase A and Phase B Pulse output logic inversion								
	Pr0.12	Phase B logic	CCW direction		CW direction			
	[0]	Not inverted	A-phase  B-phase 		A-phase  B-phase 			
	[1]	Inverted	A-phase  B-phase 		A-phase  B-phase 			

4.1.5 Positioning completed INP signal output

INP signal output will be valid when position deviation is within the range when positioning is completed. Set unit in Pr5.20.

Pr4.31	Label	Positioning complete range			Valid mode(s)	P	
	Range	0~10000	Unit	Pr5.21 set unit	Default	20	
	Byte length	16bit	Attribute	R/W	485 address	0x043F	
	Valid	Immediate					
To set position deviation range of INP1 positioning completed output signal. INP1 output signal will be valid once position is complete within the range of deviation set. <i>Default unit: 0.00001rev. Can be set on Pr5.21 as command unit (pulse) or encoder unit (pulse)</i>							
Pr4.32	Label	Positioning complete output setting			Valid mode(s)	P	
	Range	0~4	Unit	—	Default	1	
	Byte length	16bit	Attribute	R/W	485 address	0x0441	
	Valid	Immediate					
To set conditions for INP1 output signal to be valid							
		Value	Positioning completed signal				
		0	Signal valid when the position deviation is smaller than Pr4.31				
		1	Signal valid when there is no position command and position deviation is smaller than Pr4.31				
		2	Signal valid when there is no position command, zero-speed clamp detection (ZSP) signal is ON and the positional deviation is smaller than Pr4.31				
		3	Signal valid when there is no position command and position deviation is smaller than Pr4.31. Signal ON when within the time set in Pr4.33 otherwise OFF.				
		4	When there is no command, position detection starts after the delay time set in Pr4.33. Signal valid when there is no position command and positional deviation is smaller than Pr4.31.				
Pr4.33	Label	INP positioning delay time			Valid mode(s)	P	
	Range	0~15000	Unit	1ms	Default	0	
	Byte length	16bit	Attribute	R/W	485 address	0x0443	
	Valid	Immediate					
Valid when Pr4.32 = 3.							
		Set value	Positioning completed signal				
		0	Indefinite delay time, signal ON until next position command				
		1-15000	OFF within the time set; ON after time set. Switch OFF after receiving next position command.				

4.2 Velocity control mode

Velocity mode precisely controls motor rotational speed/direction using analog velocity command or internal related parameters. There are 4 types of velocity control modes for ELD2-RS series DC Servo Drives: Analog control, internal velocity 4 speeds, internal velocity 8 speeds and analog + internal velocity control. Set Pr0.01 = 1 to activate velocity control mode.

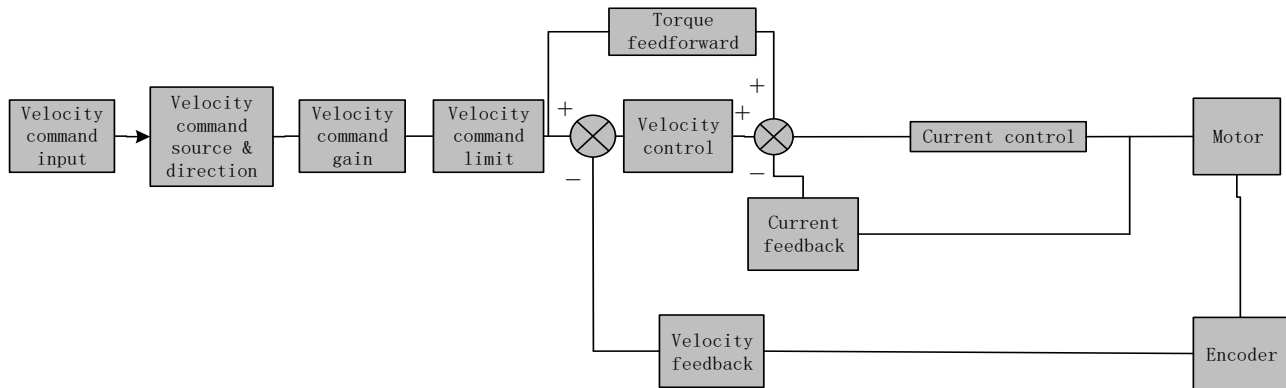

Please set related servo parameters according with the following diagram.

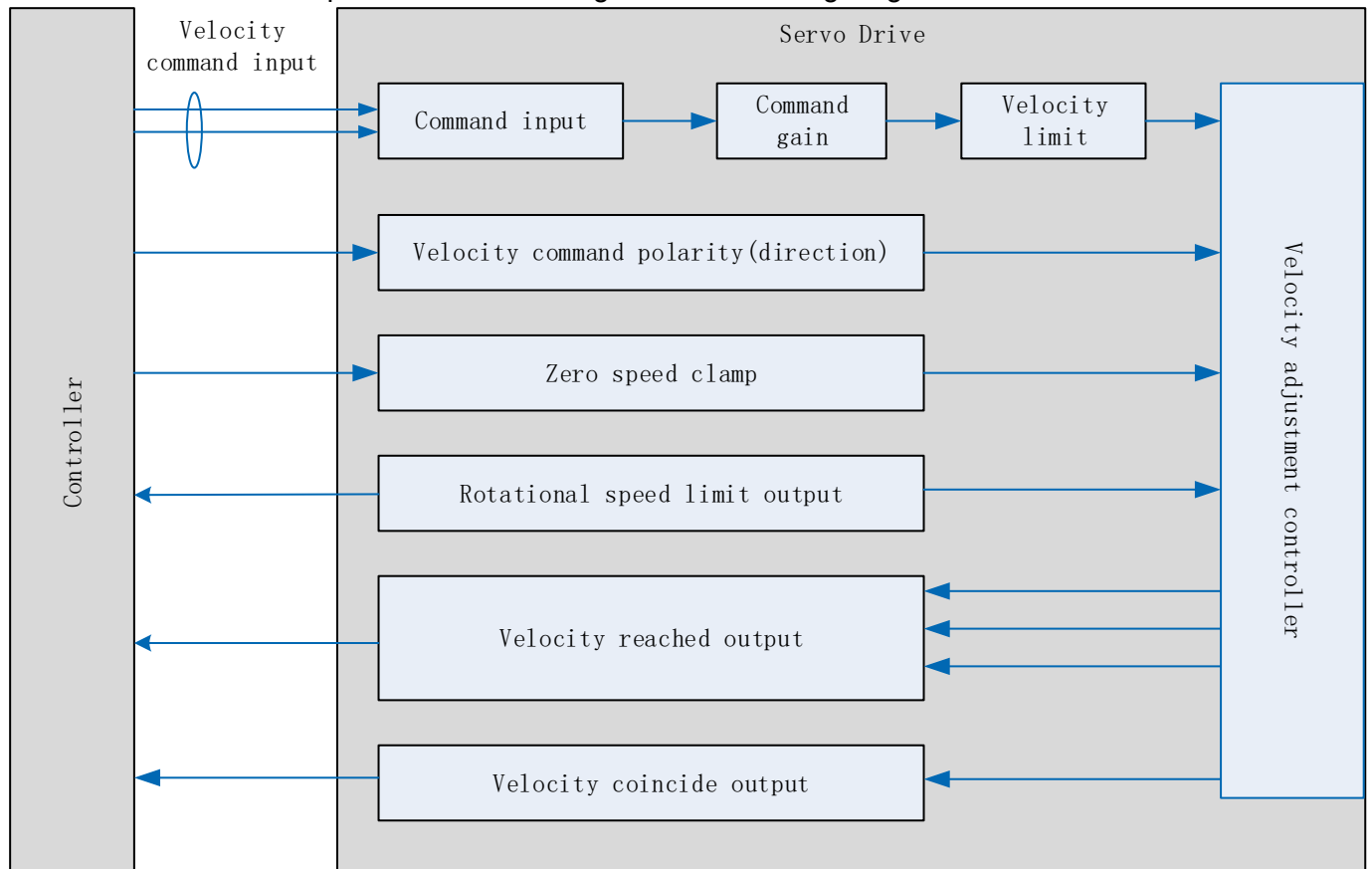

4.2.1 Velocity command input control

Set velocity control mode in Pr3.00

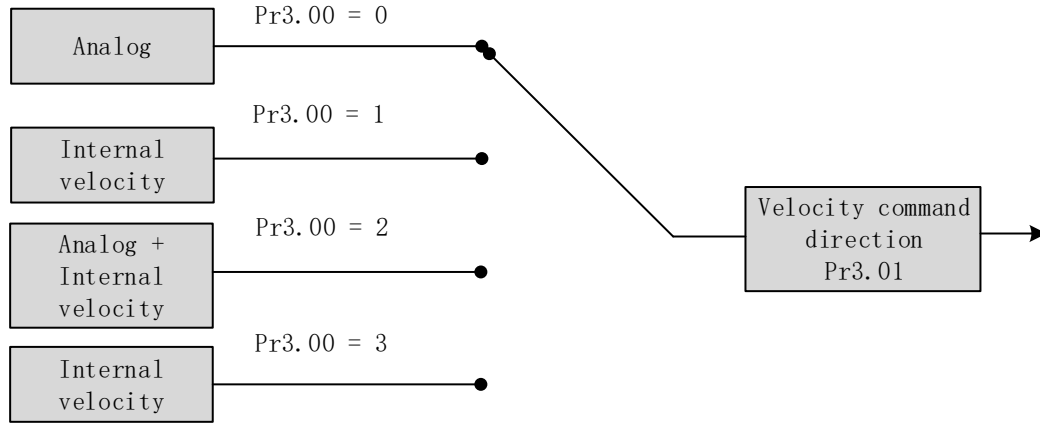

Pr3.00	Label	Velocity internal/external switching		Valid mode(s)	S
	Range	0~3	Unit	—	Default
	Byte length	16bit	Attribute	R/W	485 address
	Valid	Immediate			
	Connect to the right DI to control internal command velocity settings.				
	Value	Velocity settings			
	0	Analog - Velocity command (SPR)			
	【1】	Internal velocity settings 1 st – 4 th speed (Pr3.04~Pr3.07)			
	2	Internal velocity settings 1 st – 3 rd speed (Pr3.04~P3.06) 、 Analog velocity command (SPR)			
	3	Internal velocity settings 1 st – 8 th speed (Pr3.00~Pr3.11)			

Velocity command direction settings

Switch velocity command direction using I/O. Assign VC-SIGN to corresponding DI terminal, velocity command direction will be in accordance to DI signal.

Pr3.01	Label	Velocity command rotational direction selection		Valid mode(s)	S
	Range	0~1	Unit	—	Default
	Byte length	16bit	Attribute	R/W	485 address
	Valid	Immediate			
	To set positive/negative direction of velocity command				
	Value	Velocity settings (Analog or internal velocity)	Velocity command sign selection (VC-SIGN)	Velocity command direction	
	【0】	+	No effect	Positive	
		–	No effect	Negative	
	1	No effect	OFF	Positive	
		No effect	ON	Negative	

Velocity command input inversion

Set Analog-Velocity command (SPR) voltage polarity

Pr3.03	Label	Velocity command input inversion			Valid mode(s)	S
	Range	0~1	Unit	—	Default	0
	Byte length	16bit	Attribute	R/W	485 address	0x0307
	Valid	Immediate				

To set voltage polarity of analog velocity command.

Only valid when Pr3.01 = 0. When Pr3.01 = 1, rotational direction is only related to VC-SIGN.

Value	Motor rotational direction	
【0】	Not inversed	「 Positive voltage 」 → 「 Positive direction 」 「 Negative voltage 」 → 「 Negative direction 」
1	Inversed	「 Positive voltage 」 → 「 Positive direction 」 「 Negative voltage 」 → 「 Negative direction 」

If there is an external position sensor with different polarity from Pr3.03, motor might undergo abnormal motion.

Velocity command input gain

Set Analog-Velocity command (SPR) voltage to motor velocity command switching gain

Pr3.02	Label	Velocity command input gain			Valid mode(s)	S
	Range	10~2000	Unit	(r/min)/V	Default	500
	Byte length	16bit	Attribute	R/W	485 address	0x0305
	Valid	Immediate				

To set gain changes from voltage added onto analog velocity command (SPR) to motor command velocity

Pr3.02 sets command input voltage and rotational speed slope.

Factory default:

Pr3.02=500(r/min)/V.

Hence 6V input: 3000 r/min

1. Do not supply more than $\pm 10V$ power for analog velocity command (SPR).
2. If Pr3.02 set value is too large, it might cause vibration.

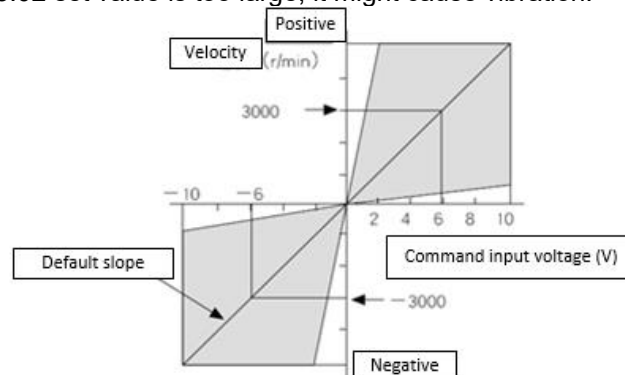

4.2.2 Velocity command acceleration/deceleration

Acceleration/Deceleration is added onto velocity command input to control velocity. This function is valid when entering step-like velocity command or internal velocity settings is used to realize motor soft start. Use Sigmoid acceleration/deceleration to reduce vibration and impact due to changes in velocity.

Pr3.12	Label	Acceleration time settings			Valid mode(s)	S
	Range	0~10000	Unit	ms/ (1000rpm)	Default	100
	Byte length	16bit	Attribute	R/W	485 address	0x0319
	Valid	Immediate				
Pr3.13	Label	Deceleration time settings			Valid mode(s)	S
	Range	0~10000	Unit	ms/ (1000rpm)	Default	100
	Byte length	16bit	Attribute	R/W	485 address	0x031B
	Valid	Immediate				

Set max acceleration/deceleration for velocity command.

If target velocity = x [rpm], max acceleration = a [unit: rpm/ms], acceleration time = t [ms]

$$\text{Pr3.12} = 1000/a$$

$$\text{Pr3.13} = 1000/a$$

$$a = x/t$$

For example: If motor is to achieve 1500rpm in 30ms at 1500/30=50rpm/ms
Pr3.12 = 1000/a = 20. Hence when Pr3.12 = 20, motor can achieve 1500rpm in 30s.

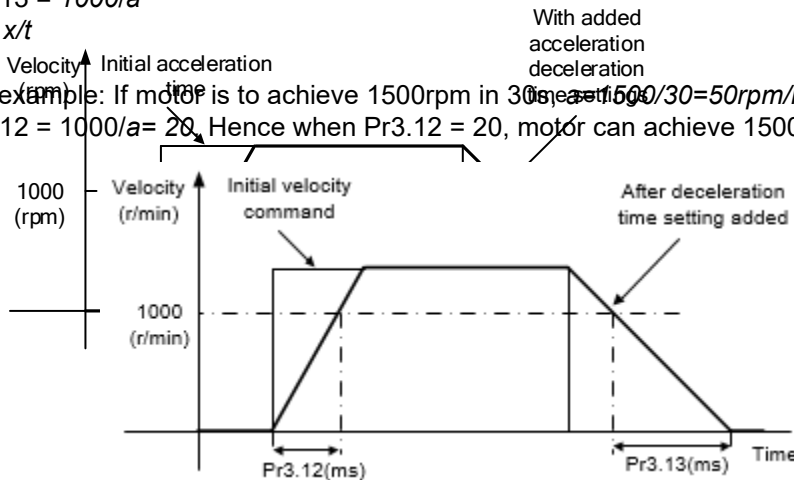

Usually used when there is rapid acceleration or trapezoidal wave velocity command due to many different internal speed segments under velocity control mode which causes instable while motor in motion.

Under velocity control mode, 6083 and 6084 is limited by Pr3.12 and Pr3.13 correspondingly.

Pr3.14	Label	Sigmoid acceleration/deceleration settings			Valid mode(s)	S
	Range	0~1000	Unit	ms	Default	0
	Byte length	16bit	Attribute	R/W	485 address	0x031D
	Valid	After restart				

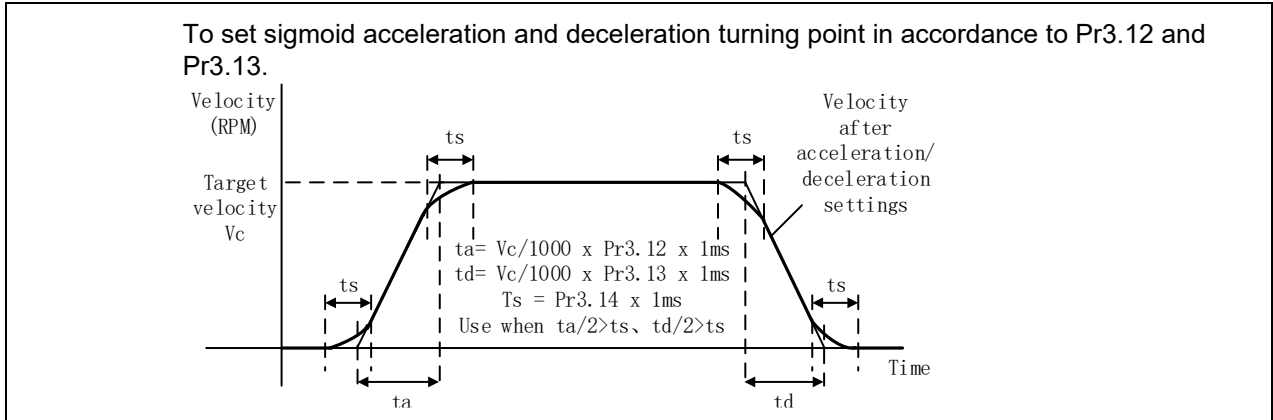

4.2.3 Velocity reached signal AT-SPEED output

Velocity reached signal AT-SPEED output will be valid when motor velocity reached set speed in Pr4.36. This output function can be assigned through I/O configurations, please refer to Pr4.10. When velocity matches set conditions, assigned I/O terminal will be ON, signal will be valid.

Pr4.36	Label	Arrival velocity			Valid mode(s)	S
	Range	10~2000	Unit	r/min	Default	1000
	Byte length	16bit	Attribute	R/W	485 address	0x0449
	Valid	Immediate				

When motor velocity > Pr4.36, AT-speed output signal is valid.
 Detection using 10RPM hysteresis.

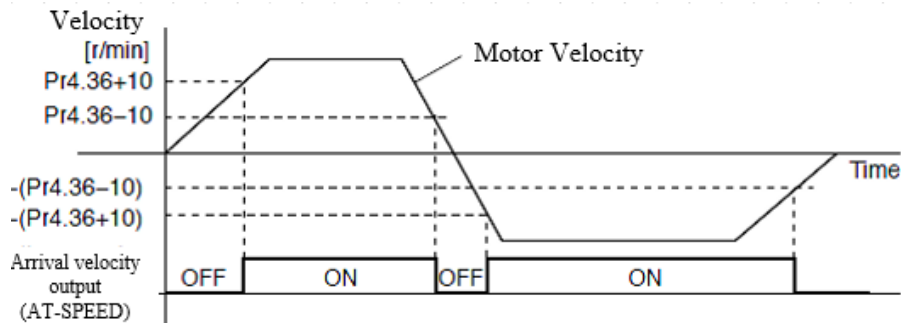

4.2.4 Velocity coincidence V-COIN signal output

V-COIN signal output will be valid when velocity command (before acceleration/deceleration) coincides with motor velocity. Velocity is considered to be coincided if the difference between velocity command before acceleration/deceleration from servo drive and motor velocity is within the value set in Pr4.35. This output function can be assigned through I/O configurations, please refer to Pr4.10. When velocity matches set conditions, assigned I/O terminal will be ON, signal will be valid. In Position signal in PV mode is in synchronization with V-COIN signal.

Pr4.35	Label	Velocity coincidence range			Valid mode(s)	S
	Range	10~2000	Unit	r/min	Default	50
	Byte length	16bit	Attribute	R/W	485 address	0x0447
	Valid	Immediate				

If the difference between velocity command and motor actual speed is below Pr4.35, Velocity coincidence (V-COIN) output signal valid.

Due to 10RPM hysteresis:
 Velocity coincidence output OFF -> ON timing (Pr4.35 -10) r/min
 Velocity coincidence output ON -> OFF timing (Pr4.35 +10) r/min

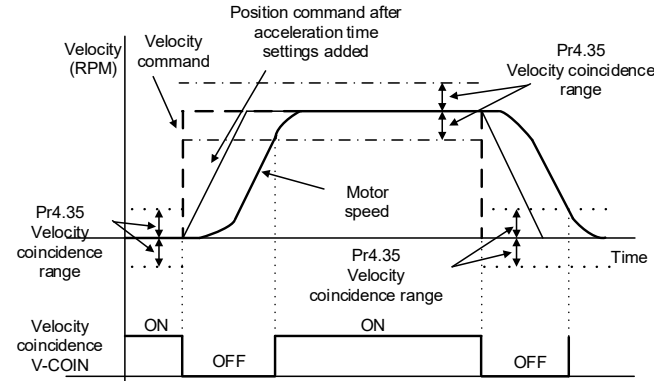

4.2.5 Zero Speed Clamp

Forced set velocity command to 0 using zero speed clamp to avoid servo axis from crawling at low velocity.

This input function can be assigned through I/O configurations, please refer to Pr4.00.

Pr3.15	Label	Zero speed clamp function selection			Valid mode(s)	S
	Range	0~3	Unit	—	Default	0
	Byte length	16bit	Attribute	R/W	485 address	0x031F
	Valid	Immediate				

Value	Zero speed clamp function
0	Invalid: zero speed clamp deactivated
1	Velocity command is forced to 0 when the zero speed clamp (ZEROSPD) input signal is valid.
2	Velocity command is forced to 0 when actual velocity is lower than Pr3.16.
3	Includes conditions from 1 and 2

Pr3.16	Label	Zero speed clamp level			Valid mode(s)	S
	Range	10~2000	Unit	r/min	Default	30

Byte length	16bit	Attribute	R/W	485 address	0x0321
	Valid		Immediate		
Valid when Pr3.15 = 2/3, velocity command is forced to 0 when actual velocity is lower than Pr3.16 and after static time set in Pr3.23.					

4.3 Torque control

Torque control mode is to the size of motor asserted torque through external analogue input or directly from set value internally. This control mode is applicable where torque is the main control and limiting factor.

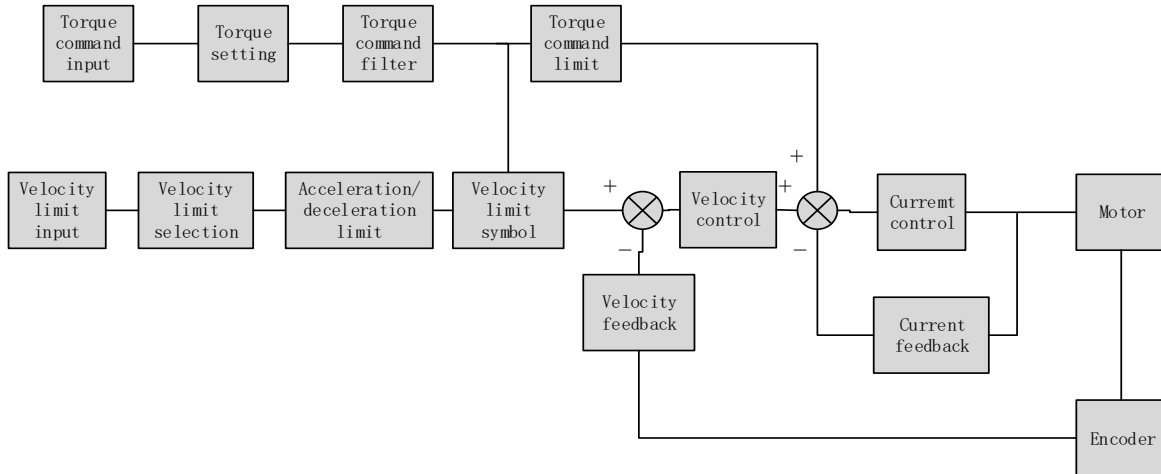

Using Motion Studio, set Pr0.01 = 2 to activate torque control mode. Please set related servo parameters according with the following diagram.

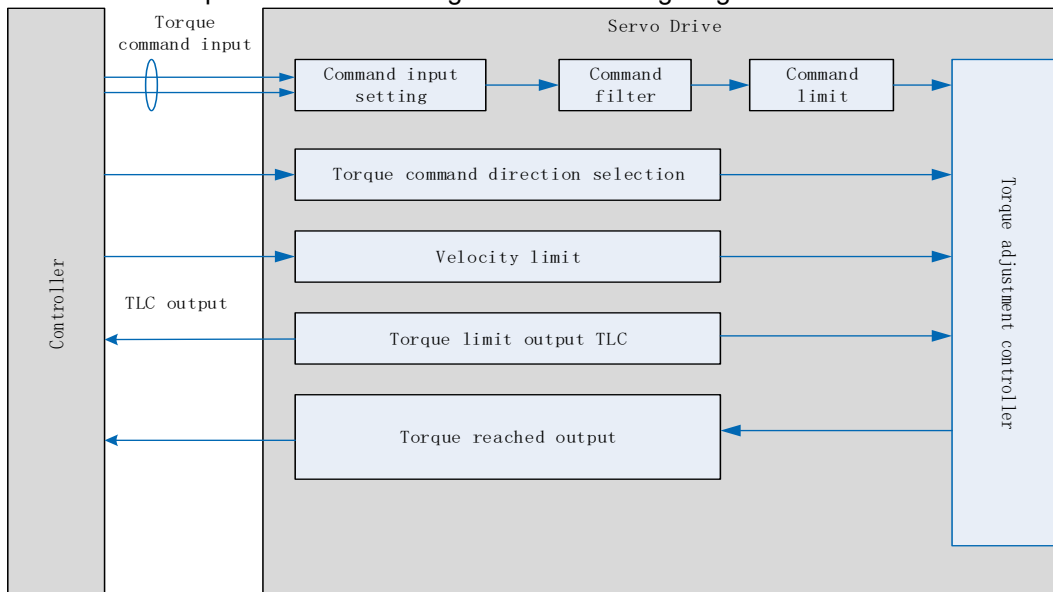

4.3.1 Torque command input control

Torque control mode settings

Torque control mode includes 3 control modes as shown below. Set torque control mode in Pr3.17.

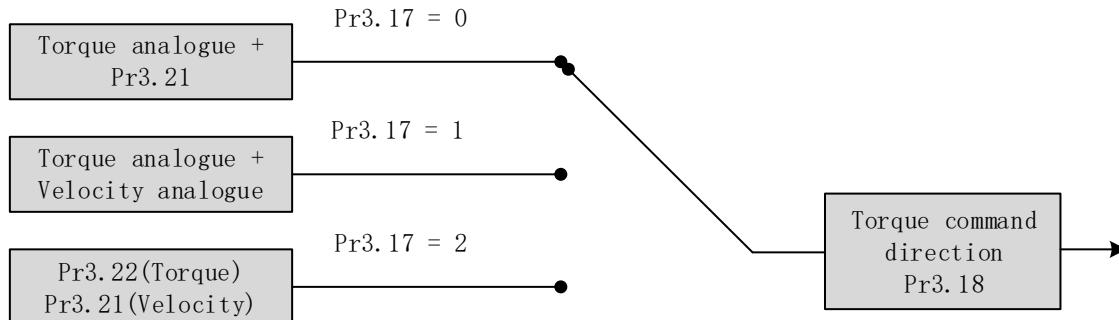

Pr3.17	Label	Torque internal/external switching			Valid mode(s)		T
	Range	0~2	Unit		Default	0	
	Byte length	16bit	Attribute	R/W	485 address	0x0323	
	Valid	Immediate					
	Value	Torque command input		Velocity limit input			
	【0】	Analog input 3(AI 3)		Pr3.21 set value			
	1	Analog input 3(AI 3)		Analog input 1(AI 1)			
	2	Pr3.22 set value		Pr3.21 set value			

Torque command direction settings

To switch velocity command direction through DI. Assign TC-SIGN signal to corresponding DI terminal and determine velocity command direction through digital input signal.

Pr3.18	Label	Torque command direction selection			Valid mode(s)		T
	Range	0~1	Unit	—	Default	0	
	Byte length	16bit	Attribute	R/W	485 address	0x0325	
	Valid	Immediate					

To set torque command positive/negative direction

Value	Direction settings
【0】	TC-SIGN ON/OFF has no effect on torque direction Torque command input 「 Positive 」 → Positive direction, 「 Negative 」 → Negative direction
1	Use TC-SIGN ON/OFF status for torque direction OFF: <i>Positive direction</i> ON: <i>Negative direction</i>

Torque command input inversion

To set the voltage polarity added onto analogue torque command (TRQR)

Pr3.20	Label	Torque command input inversion			Valid mode(s)		T
	Range	0~1	Unit	—	Default	0	
	Byte length	16bit	Attribute	R/W	485 address	0x0329	
	Valid	Immediate					

To set voltage polarity of analog torque command.
Only valid when Pr3.18 = 0.

Value	Motor torque direction	
【0】	Not inversed	「 Positive voltage 」 → 「 Positive direction 」 「 Negative voltage 」 → 「 Negative direction 」
1	Inversed	「 Positive voltage 」 → 「 Positive direction 」 「 Negative voltage 」 → 「 Negative direction 」

Torque command input gain

To set voltage added on to switching gain of motor torque command from analog torque command (TRQR)

Pr3.19	Label	Torque command input gain			Valid mode(s)		T
	Range	10~100	Unit	0.1V/100%	Default	30	
	Byte length	16bit	Attribute	R/W	485 address	0x0327	
	Valid	Immediate					

To set gain changes from voltage added onto analog torque command (TRQR) to torque command (%)

- Unit: (0.1V/100%)。
- Set input voltage required for rated output torque.
- Default = 30, which is 3V/100%

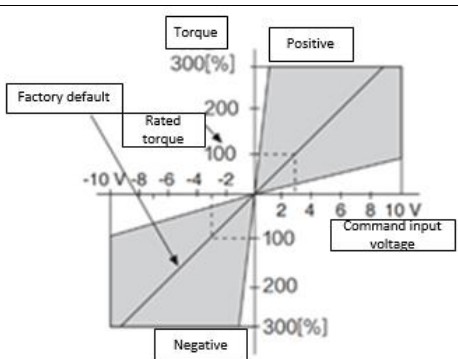

4.3.2 Torque velocity limit

To set velocity limit in torque mode for safety reasons.

Pr3.21	Label	Velocity limit in torque mode			Valid mode(s)		T
	Range	0~10000	Unit	r/min	Default	0	
	Byte length	16bit	Attribute	R/W	485 address	0x032B	
	Valid	Immediate					
To set velocity limit in torque control mode. Only valid when Pr3.17 = 0 / 2.							
Pr3.22	Label	Torque command			Valid mode(s)		T
	Range	0~300	Unit	%	Default	0	
	Byte length	16bit	Attribute	R/W	485 address	0x032D	
	Valid	Immediate					
To set torque limit in torque control mode. Only valid when Pr3.17 = 2. Please refer to Pr3.17.							

4.3.3 Torque limit (TL-SEL)

This input function can be assigned through I/O configurations, please refer to Pr4.00.

To set torque limiting method.

Pr5.21	Label	Torque limit selection			Valid mode(s)	P	S	T																						
	Range	0~6	Unit	—	Default	0																								
	Byte length	16bit	Attribute	R/W	485 address	0x052B																								
	Valid	Immediate																												
<table border="1" style="width: 100%; border-collapse: collapse;"> <thead> <tr> <th style="width: 20%;">Value</th> <th style="width: 20%;"></th> <th style="width: 60%;">Limit</th> </tr> </thead> <tbody> <tr> <td>【0】</td> <td></td> <td>1st torque limit Pr0.13</td> </tr> <tr> <td>1</td> <td></td> <td>2nd torque limit Pr5.22</td> </tr> <tr> <td rowspan="2">2</td> <td>TL-SEL OFF</td> <td>Pr0.13</td> </tr> <tr> <td>TL-SEL ON</td> <td>Pr5.22</td> </tr> <tr> <td>3~4</td> <td></td> <td>Reserved</td> </tr> <tr> <td rowspan="2">5</td> <td></td> <td>Pr0.13 → Positive torque limit</td> </tr> <tr> <td></td> <td>Pr5.22 → Negative torque limit</td> </tr> </tbody> </table>									Value		Limit	【0】		1 st torque limit Pr0.13	1		2 nd torque limit Pr5.22	2	TL-SEL OFF	Pr0.13	TL-SEL ON	Pr5.22	3~4		Reserved	5		Pr0.13 → Positive torque limit		Pr5.22 → Negative torque limit
Value		Limit																												
【0】		1 st torque limit Pr0.13																												
1		2 nd torque limit Pr5.22																												
2	TL-SEL OFF	Pr0.13																												
	TL-SEL ON	Pr5.22																												
3~4		Reserved																												
5		Pr0.13 → Positive torque limit																												
		Pr5.22 → Negative torque limit																												
Pr5.22	Label	2 nd torque limit			Valid mode(s)	P	S	T																						
	Range	0~500	Unit	%	Default	300																								
	Byte length	16bit	Attribute	R/W	485 address	0x052D																								
	Valid	Immediate																												
Pr5.22 is limited by max. torque set in motor parameter.																														

Pr0.13	Label	1 st torque limit			Valid mode(s)	P	S	T
	Range	0~500	Unit	%	Default	350		
	Byte length	16bit	Attribute	R/W	485 address	0x001B		
	Valid	Immediate						
1 st torque limit is set according to ratio percentage of motor rated current. Do not exceed max driver output current. Please refer to Pr5.21 on how to set torque limit.								

4.4 Hybrid Control Mode

Hybrid control mode is for servo drive to be able to switch between different modes during operation. Hybrid control mode consists of the 3 listed below:

- Position-velocity mode
- Position-torque mode
- Velocity-torque mode

Set Pr0.01 to select the hybrid control mode needed through Motion Studio or servo drive front panel.

Pr0.01	Label	Control Mode Settings			Valid mode(s)	P	S	T
	Range	0~10	Unit	—	Default	0		
	Byte length	16bit	Attribute	R/W	485 address	0x0003		
	Valid	After restart						

Value	Description	
	1 st mode	2 nd mode
【0】	Position	—
1	Velocity	—
2	Torque	—
3	Position	Velocity
4	Position	Torque
5	Velocity	Torque
6	PR internal command control	Position Pr0.22=1
		Velocity Pr0.22=1
		Torque Pr0.22=2
7~10	Reserved	

◆When 3, 4, 5, 6 combination hybrid mode, 1st and 2nd mode can be chosen accordingly with control mode switching input (C-MODE).
 C-MODE: Invalid, select 1st mode.
 C-MODE: Valid, select 2st mode.
 Please allow some time in between mode switching commands.
 ◆Please set Pr0.01 = 6 to switch to other modes from PR mod, then set 2nd mode using Pr0.22.
C-MODE is defaulted to Normally Open

When Pr0.01 = 3/4/5, please set assign C-MODE mode switching signal to one of the DI terminal and make sure the logic is valid.

Signal	Set value	Label	Description		
			Pr0.01	C-MODE	Control mode
C-MODE	0x5	Control mode switching	3	Invalid	Position mode
				Valid	Velocity mode
			4	Invalid	Position mode
				Valid	Torque mode
			5	Invalid	Velocity mode
				Valid	Torque mode

Chapter 5 Application Case

5.1 Gain Adjustment

In order for servo driver to execute commands from master device without delay and to optimize machine performance, gain adjustment has to be done yet.

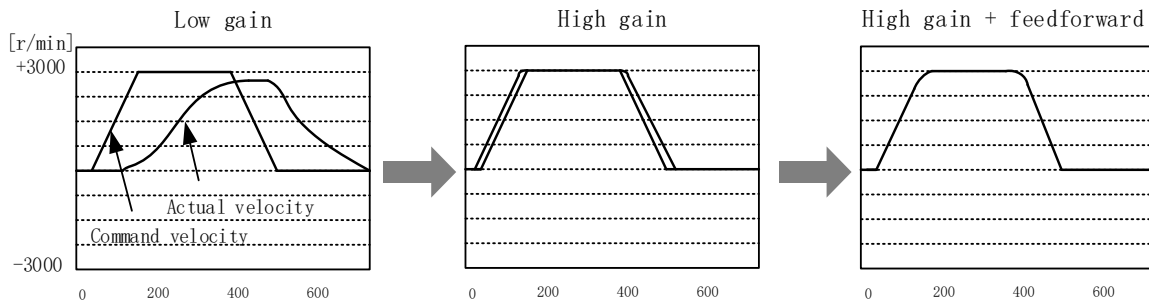

Position loop gain: 320 (0.1/s)
Velocity loop gain: 180 (0.1Hz)
Velocity loop integral time constant: 31ms

Position loop gain: 900 (0.1/s)
Velocity loop gain: 500 (0.1Hz)
Velocity loop integral time constant: 31ms

Position loop gain: 900 (0.1/s)
Velocity loop gain: 500 (0.1Hz)
Velocity loop integral time constant: 31ms

Servo driver gain adjustment is done in combination with a few other parameters (Inertia ratio, Position loop gain, Velocity loop gain and Filters settings). These parameters will have an effect on each other so it always advisable to tune each parameter according in order to achieve optimal machine performance. Please refer to the steps below

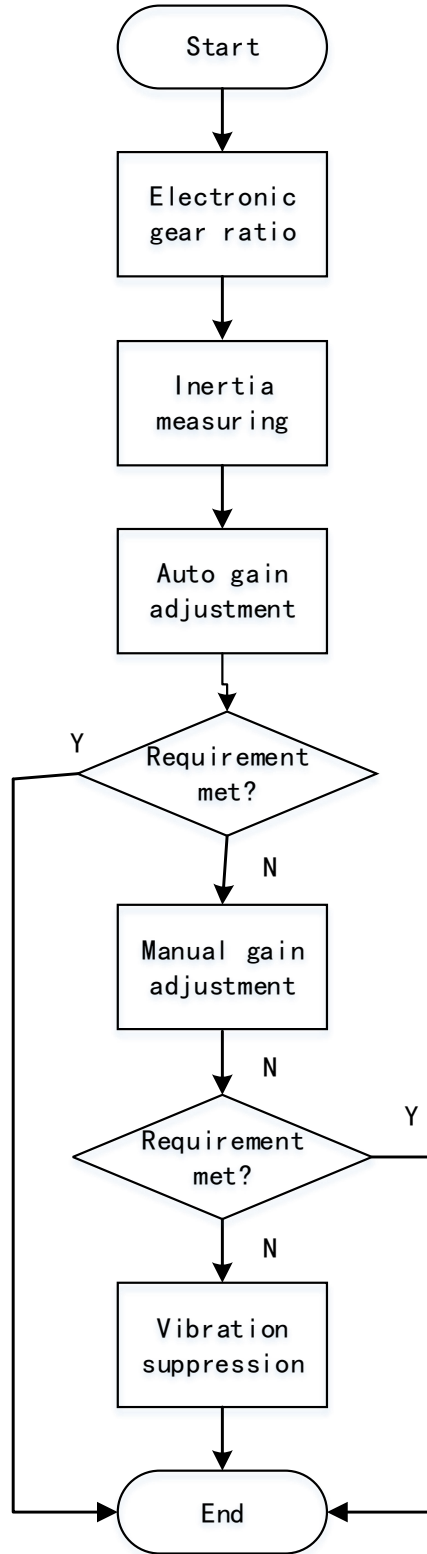

Gain Adjustment Flow Chart

Steps	Functions	Explanation
Inertia ratio identification	Online	Motor moves with command from controller, servo driver will automatically calculate load-inertia ratio
Auto gain adjustment	Auto gain adjustment	Real time determining of mechanical load, gain value is set accordingly. <ol style="list-style-type: none"> One-click tuning (Can be realized using Motion Studio. Auto tuning of gain and inertia according to actual data) Real time auto adjustment (Set by selecting mechanical stiffness level, related gain parameters will be automatically adjusted accordingly)
Manual gain adjustment	Basic gain	On top of auto gain adjustment, manually adjust related parameters so that machine can have better responsiveness and following
	Basic steps	<ol style="list-style-type: none"> Gain related parameters tuning under position mode Gain related parameters tuning under velocity mode Gain related parameters tuning under torque mode
	Gain switching	Gain switching through internal data or external signal. Lower vibration at stop, shorten tuning time, improve command following.
	Model following control	Improve responsiveness, shorten positioning time (Only available in position mode)
	Command pulse filter	Set filter for position, velocity and torque command pulse.
	Gain feedforward	Enable feedforward function to improve following behavior
	Friction compensation	Reduce the effect of mechanical friction
	3 rd gain switching	Base on usual gain switching function. Can be set to switch gain at stopping and reduce positioning time.
Vibration suppression	Mechanical resonance	Using notch filtering function to suppress mechanical resonance.
	End vibration suppression	To suppress low frequency vibration of mechanical end

5.2 Inertia ratio identification function

Inertia ratio = Total mechanical load rotational inertia / Motor rotational inertia

Inertia ratio is an important parameter. Setting a suitable value can help with the precise tuning of the servo system. Inertia ratio can be set manually and also be determined automatically through servo driver

To make sure accurate inertia ratio identification:

- Max rotational velocity at 400rpm
- Acceleration/deceleration time above 100ms
- Stable load torque without large variation.

Online inertia determination

Enable motor using controller. Let motor run at above 400rpm, make sure there are acceleration, constant velocity and deceleration phase during the whole run. Cycle through 2-3 times to calculate load-inertia ratio. Result can be found on the front panel d16 or through Motion Studio system monitoring page. Enter the calculated value into Pr0.04 and save.

Inertia measuring using Motion Studio

1. Start Motion Studio and maneuver to inertia ratio identification page under performance tuning. Set trial run velocity Pr6.04 and acc-/deceleration time Pr6.25, click on 'Upload' to upload parameters to servo driver.
2. Tick "Prohibit external enabling" and click on "servo on".
3. Click and hold "CCW" to start the motor. Current position will show motor cycles of revolution. Click on POS 1 to save current position as starting point. Click and hold "CW" to start the motor again. Click on POS 2 to save current position as ending point.
4. Set the waiting time between each cycle in Pr6.21 and no. of cycles in Pr6.22. Click on 'Run' and motor will run according to the parameters set.

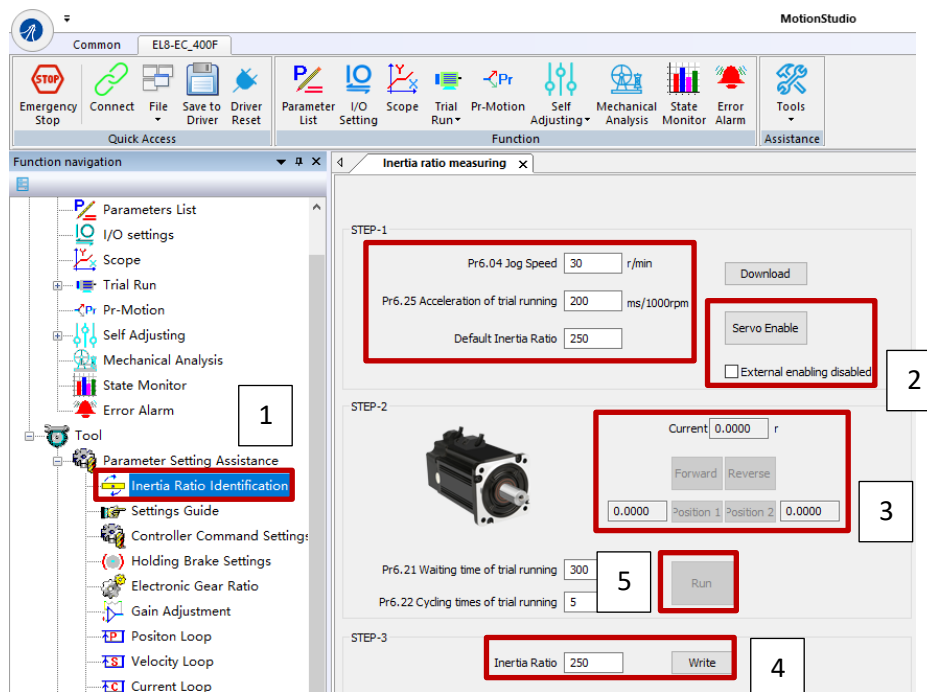

5. After the calculation is done, inertia ratio will be calculated automatically and click on 'write' to enter the calculated value into Pr0.04.

6. Click on “Parameter List” to enter parameters management to check or modify Pr0.04. Then, click on “Save” to save parameters to driver.

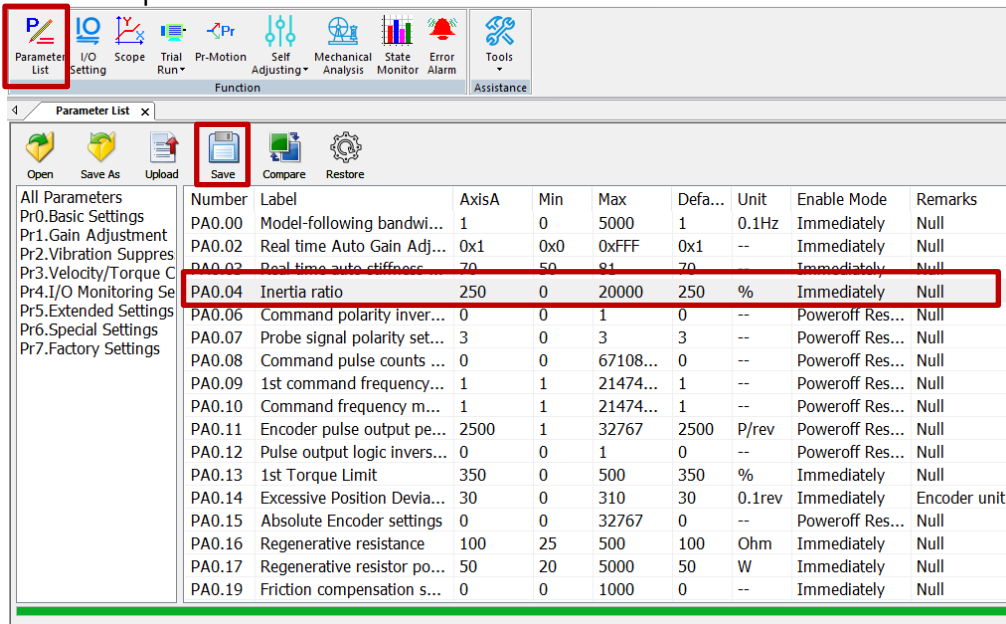

Please take note:

1. Trial run velocity and distance should be optimal to prevent any axis from bumping into objects.
2. It is recommended to move only in 1 direction for vertically mounted axis. Take precaution before moving the axis.
3. For applications with higher frictional drag, please set a minimal travel distance.

Pr0.04	Label	Inertia ratio			Valid mode(s)	P	S	T
	Range	0~20000	Unit	%	Default	250		
	Byte length	16bit	Attribute	R/W	485 address	0x0009		
	Valid	Immediate						
Pr0.04=(load inertia/motor rotational inertia)*100%								
Set inertia ratio according to actual load inertia. When both are uniform, actual motor velocity loop responsiveness and gain settings will be consistent. If inertia ratio is greater than actual value, velocity loop gain settings will be higher and vice versa. For motor with high inertia, Pr0.04 can be left unfilled but optimal setting of Pr0.04 could improve system performance								

Common issues

Error	Cause	Solution
Inertia measuring failure	Loose load connection	Check for mechanical failure
	Measuring distance is too short	Increase measuring distance
	Belt load	Please pre-set an inertia ratio when using a belt to prevent jolt due to low inertia.

5.3 Auto gain adjustment

This function will measure real time mechanical properties and set gain values in accordance to mechanical stiffness. Can be used in any control mode

Conditions to implement	
Control mode	Please refer to Pr0.02 for detailed explanations. Auto gain adjustment is different for each control mode.
Other	<ul style="list-style-type: none"> • Servo driver needs to be enabled • Set up input signals such as deviation counter clearing and command input; Torque limit and other motion control parameters to enable motor to move normally without obstacles.

- Under certain conditions, external factors might affect automatic gain adjustment functions. If the conditions as listed exist or unfavorable, please disable the automatic gain adjustment function.

Affecting conditions	
Load inertia	<ul style="list-style-type: none"> • If inertia is less than 3 times or over 20 times of rotor inertia. • Changes in load inertia
Load	<ul style="list-style-type: none"> • Very low mechanical stiffness • If gear backlash is a non-linear property
Motion	<ul style="list-style-type: none"> • Velocity less than 100r/min or continuously in low velocity mode • Acc-/deceleration to 2000r/min within 1s. ◦ • Acc-/deceleration torque lower than eccentric load, frictional torque. • Velocity < 100r/min, acc-/deceleration to 2000r/min within 1s but not longer than 50ms

To enable automatic gain adjustment:

1. Disable the servo driver.
2. Set Pr0.02 = 0x01/0x11 or 0x02/0x12. Then, set Pr0.03
3. Servo enabled. Run motion as normal to start measuring load properties. Related parameters will be automatically set.
4. Increase motor responsiveness by increasing Pr0.03. Please check if there is any vibration before setting Pr0.03 to max. value.
5. Save the parameters.

Please take note:

- Please stop the motor before modifying any parameter. Pr0.02 only takes effect after saving modified parameter values into EEPROM and restarting the driver.

- After enabling the servo driver for the first time or when increasing Pr0.03, mechanical noise or vibration might occur for the first run, it is normal. If it persists, please set Pr0.03 to lower value.

Parameters that change in accordance to real time gain adjustment

There are 2 types of auto gain adjustment methods:

- **Standard mode** (Pr0.02 = 0x__1): Basic mode, prioritizing on stability, gain switching is disabled. Actual gain auto adjustment as accordance to Pr0.03.
Gain related parameters that change as shown below.

Parameter	Label	Remarks
Pr1.00	1 st position loop gain	When stiffness setting is valid, parameters will be updated to match stiffness value
Pr1.01	1 st velocity loop gain	
Pr1.02	1 st velocity integral time constant	
Pr1.03	1 st velocity detection filter	
Pr1.04	1 st torque filter	

Gain related that doesn't change

Parameter	Label	Reference value	Remarks
Pr1.10	Velocity feedforward gain constant	300 (0.1%)	Doesn't change according to changes in stiffness

- **Positioning mode** (Pr0.02=0x2): Prioritizing positioning. Usually applies on horizontal axis without variable load, ball screws with lower friction, gain switching enabled. Stiffness level of 2nd position loop gain is 1 level higher than 1st position.

No.	Parameters	Label	Remarks
1	Pr1.00	1 st position loop gain	When stiffness setting is valid, parameters will be updated to match stiffness value
2	Pr1.01	1 st velocity loop gain	
3	Pr1.02	1 st velocity integral time constant	
4	Pr1.03	1 st velocity detection filter	
5	Pr1.04	1 st torque filter	
6	Pr1.05	2 nd position loop gain	
7	Pr1.06	2 nd velocity loop gain	
8	Pr1.07	2 nd velocity integral time constant	
9	Pr1.08	2 nd velocity detection filter	
10	Pr1.09	2 nd torque filter	

If auto gain adjustment is valid, the parameters listed above can't be manually modified. Only when Pr0.02 = 0x00 or 0x10, can the gain related parameters be modified manually.

Gain related parameters that don't change with the real time gain adjustment

Parameter	Label	Reference value
Pr1.10	Velocity feedforward gain constant	1000ms
Pr1.11	Velocity feedforward filter time constant	30%
Pr1.12	Torque feedforward gain	0.50ms
Pr1.13	Torque feedforward filter time constant	0
Pr1.15	Position control gain switching mode	0
Pr1.17	Position control switching level	10
Pr1.18	Position control switching hysteresis	50
Pr1.19	Position gain switching time	33

Types of mechanical load

Please select mechanical load according to load-inertia ratio and mechanical structures:

Load types	Description
0x00_ : Rigid structure	When load is rigid with relatively low inertia . Gain adjustments prioritize system responsiveness . Structures including high precision reducer, lead screws, mechanical gears, etc.
0x01_ : High inertia	High load inertia (10 times or above). Gain adjustments prioritize operation stability and responsiveness . Recommended mechanical stiffness level not more than 15 .
0x02_ : Flexible structure	When load is flexible with relatively high inertia . Gain adjustments prioritize operation stability . Structures including long transportation belt or chain.

Structures with high inertia can have better performance if inertia ratio is set accurately.

Pr0.02	Label	Real time Auto Gain Adjusting			Valid mode(s)	P	S	T
	Range	0x0~0xFF	Unit	—	Default	0x1		
	Byte length	16bit	Attribute	R/W	485 address	0x0005		
	Valid	Immediate						
Data bits	Category	Settings	Application					
0x00_	Motion setting mode	Used to set motion setting mode, which can be selected according to the motion characteristics or setting requirements. Generally, it is recommended to select mode 1 with good generality when there is no special requirement, mode 2 when rapid positioning is needed. If mode 1 and mode 2 cannot meet the requirements, please choose mode 0.						
		0:Manual	Pr0.03 invalid. Gain value must be adjusted manually and accordingly.					
		1:Standard	Pr0.03 valid. Quick gain adjusting can be achieved by changing Pr0.03 stiffness value. Gain switching is not used in this mode, suitable for applications with requirements for stability.					
		2:Positioning	Pr0.03 valid. Quick gain adjusting can be achieved by changing Pr0.03 stiffness value. This mode is suitable for applications requiring quick positioning. Not recommended for load mounted vertical to ground, or please compensate for the load using Pr6.07					

0x0_0	Load type setting	Used to select the load type, choose according to load-inertia ratio and mechanical structure.	
		0: Rigid structure	This mode prioritizes system responsiveness. Use this mode when there is a relatively rigid structure with low load inertia. Typical application including directly connected high-precision gearbox, lead screw, gears, etc.
		1: High inertia	For applications with higher load inertia (10 times or above), gain settings take into account both machine stability and responsiveness. Not recommended to set stiffness above 15 for high load inertia.
		2: Flexible structure	This mode prioritizes system stability. Use this mode when there is low rigidity structure with high load inertia. Typical applications included belts and chains.
0x_00	reserved		

The setting type combination is a hexadecimal standard, as follows:

Setting type combination	Application type
0X000	Rigid structure + Manual
0X001	Rigid structure + Standard
0X002	Rigid structure + Positioning
0X010	High inertia + Manual
0X011	High inertia + Standard
0X012	High inertia + Positioning
0X020	Flexible structure + Manual
0X021	Flexible structure + Standard
0X022	Flexible structure + Positioning

Pr0.03	Label	Real time auto stiffness adjusting			Valid mode(s)	P	S	T
	Range	0 ~ 31	Unit	—	Default	11		
	Byte length	16bit	Attribute	R/W	485 address	0x0007		
	Valid	Immediate						
<div style="text-align: center;"> <p>Low → Mechanical stiffness → High</p> <p>Low → Servo gain → High</p> <div style="border: 1px solid black; padding: 5px; display: inline-block; margin: 10px 0;"> 81.80.....70.69.68.....51.50 </div> <p>Low → Responsiveness → High</p> </div> <p>Lower values ensure better system responsiveness and mechanical stiffness but machine vibration might occur, please set accordingly. Recommend to set to around 15 with motor with high inertia.</p>								

Gain parameters settings table

Stiffness	1 st gain				2 nd gain			
	Pr1.00	Pr1.01	Pr1.02	Pr1.04	Pr1.05	Pr1.06	Pr1.07	Pr1.09
	Position loop gain (0.1/s)	Velocity loop gain (Hz)	Velocity loop integral time constant (0.1ms)	Torque filter (0.01ms)	Position loop gain (0.1/s)	Velocity loop gain (Hz)	Velocity loop integral time constant (0.1ms)	Torque filter (0.01ms)
81	20	15	3700	1500	25	15	10000	1500
80	25	20	2800	1100	30	20	10000	1100
79	30	25	2200	900	40	25	10000	900
78	40	30	1900	800	45	30	10000	800
77	45	35	1600	600	55	35	10000	600
76	55	45	1200	500	70	45	10000	500
75	75	60	900	400	95	60	10000	400
74	95	75	700	300	120	75	10000	300
73	115	90	600	300	140	90	10000	300
72	140	110	500	200	175	110	10000	200
71	175	140	400	200	220	140	10000	200
70	320	180	310	126	380	180	10000	126
69	390	220	250	103	460	220	10000	103
68	480	270	210	84	570	270	10000	84
67	630	350	160	65	730	350	10000	65
66	720	400	140	57	840	400	10000	57
65	900	500	120	45	1050	500	10000	45
64	1080	600	110	38	1260	600	10000	38
63	1350	750	90	30	1570	750	10000	30
62	1620	900	80	25	1880	900	10000	25
61	2060	1150	70	20	2410	1150	10000	20
60	2510	1400	60	16	2930	1400	10000	16
59	3050	1700	50	13	3560	1700	10000	13
58	3770	2100	40	11	4400	2100	10000	11
57	4490	2500	40	9	5240	2500	10000	9
56	5000	2800	35	8	5900	2800	10000	8
55	5600	3100	30	7	6500	3100	10000	7
54	6100	3400	30	7	7100	3400	10000	7
53	6600	3700	25	6	7700	3700	10000	6
52	7200	4000	25	6	8400	4000	10000	6
51	8100	4500	20	5	9400	4500	10000	5
50	9000	5000	20	5	10500	5000	10000	5

5.4 Manual gain adjustment

Due to limitation of load conditions, automatic gain adjustment might not achieve expected performance. Control can be improved through manual gain adjustment

The servo system is made up of 3 control loops. From outer to inner: position loop, velocity loop, current loop as shown in the diagram below.

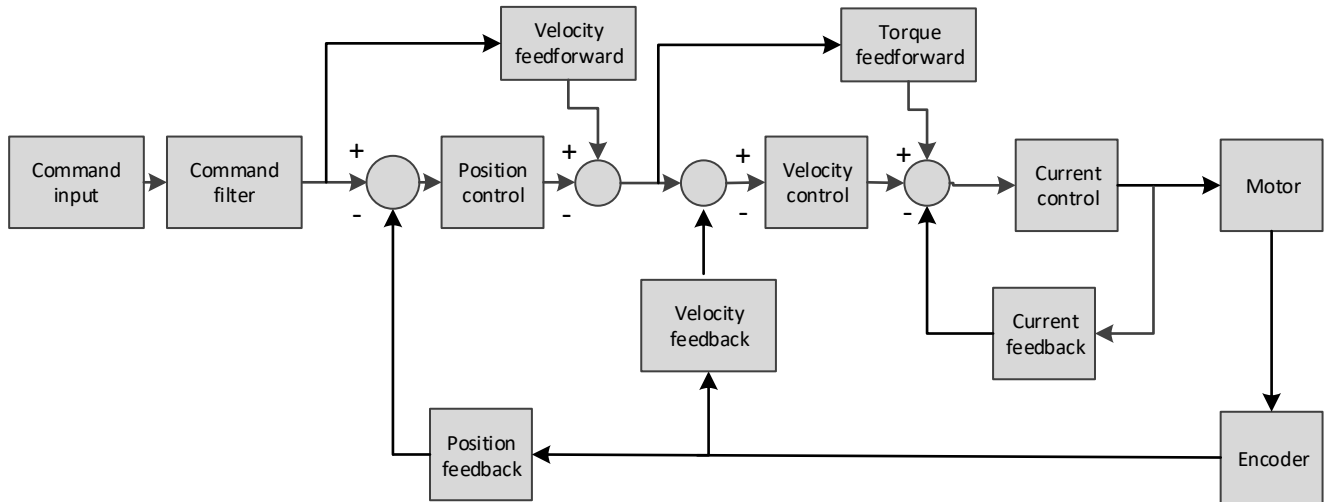

Inner control loop demands higher responsiveness. In order to avoid system instability, please tune in accordance to this principle. Current loop gain usually satisfies the responsiveness demand without tuning. When gain adjustment is done under position control mode, in order to keep the system stable, position and velocity loop gain have to be increased at the same time to make sure the responsiveness of the position loop is lower than velocity loop.

Steps to tuning (Position and velocity control)

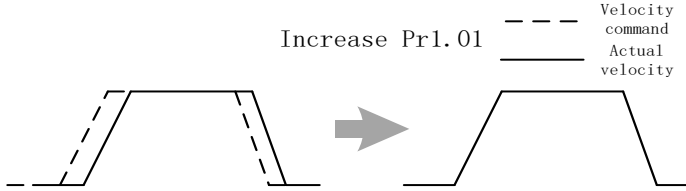
Step	Parameter	Label	Tuning method
1	Pr1.01	Velocity loop gain	<p>Determine if velocity loop is able to follow the changes in velocity command at highest frequency. If Pr0.04 is set correctly, velocity loop highest following frequency = Pr1.01</p> <p>Increase Pr1.01</p>  <p> Velocity command Actual velocity </p> <p>Increase Pr1.01 provided there is no noise or vibration to reduce positioning time, better velocity stability and following. Reduce Pr1.01 if there is mechanical noise. Set up vibration suppression if there is mechanical vibration.</p>

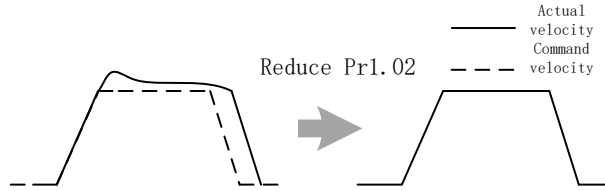
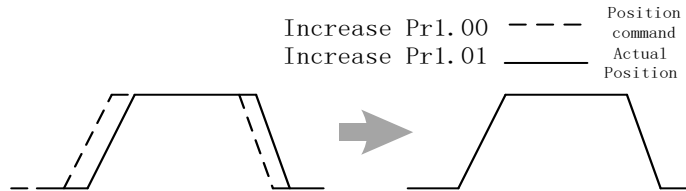
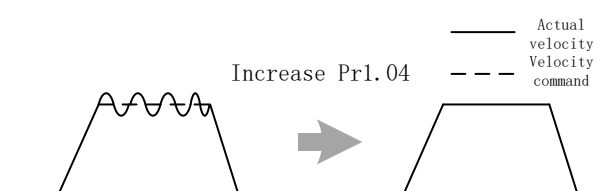
Step	Parameter	Label	Tuning method
2	Pr1.02	Velocity loop integral time constant	<p>To eliminate velocity loop deviation</p>  <p>Reduce Pr1.02</p> <p>Velocity loop integral time constant (ms) = $4000 / (2 * \pi * \text{Velocity loop gain(Hz)})$</p> <p>Reduce Pr1.02 to reduce positioning time. Mechanical vibration might occur if set value is too low; Velocity loop deviation can't be zeroed if set value is too high. Reduce Pr1.02 to increase systemic stiffness, reduce deviation, provided that there is no resonance or noise in the system. If load-inertia ratio is high or resonance exists in mechanical system, increase Pr1.02.</p>
3	Pr1.00	Position loop gain	<p>Determine if position loop is able to follow the changes in position command at highest frequency. Position loop highest following frequency = Pr1.00</p>  <p>Increase Pr1.00 Increase Pr1.01</p> <p>Increase Pr1.00 to reduce position following deviation, reduce positioning time provided that there is no resonance or noise in the system. If Pr1.00 is set too high, it might cause trembling in the mechanical system or positioning overshoot</p>
4	Pr1.04	1 st torque filter time constant	<p>Eliminate high frequency noise, suppress mechanical resonance.</p>  <p>Increase Pr1.04</p> <p>System response improves with lower set value but there is mechanical limitations; High frequency resonance suppression improves with higher set value but it might cause reduction in response bandwidth and phase margin, resulting in system turbulence. Torque filtering frequency is 4 times higher than velocity loop max following frequency: $1000000 / (2\pi * \text{Pr1.04}) \geq \text{Pr1.01} * 4$ For example, when Pr1.01=180 (0.1 Hz) , Pr1.04 should satisfy: $\text{Pr1.04} \leq 221$ (0.01ms)</p>

1. If vibration occurs with increasing Pr1.01, please modify Pr1.04 to suppress vibration.
2. If the parameters are set too high, it might cause current loop response to reduce.
3. To suppress vibration at stop, increase Pr1.01 and decrease Pr1.04.
4. Decrease Pr1.04 if motor vibrates too much at rest.
5. Pr1.04 cannot be set to overly high value as it might cause control system instability because the torque loop response is much higher than velocity loop.

For servo gain, if any one of the parameters is changed, please modify other gain related parameters accordingly. Make sure to the change at around 5% and follow the rules as below.

- 1) Increase responsiveness
 - a) Reduce torque command filter time
 - b) Increase velocity loop gain
 - c) Decrease velocity loop integral time
 - d) Increase position loop gain
- 2) Decrease responsiveness, prevent vibration and over shoot
 - a) Reduce position loop gain
 - b) Increase velocity loop integral time
 - c) Reduce velocity loop gain
 - d) Increase torque filter time

5.4.1 Parameters adjustment under different control modes

Under different control mode, parameters adjustment has to be adjusted in this order:
 “Inertia measuring” -> “Auto gain adjustment”->” Manual gain adjustments”

Position control mode

Set load-inertia ratio Pr0.04 after inertia determination.

No.	Parameter	Label
1	Pr1.00	1 st position loop gain
2	Pr1.01	1 st velocity loop gain
3	Pr1.02	1 st velocity integral time constant
4	Pr1.03	1 st velocity detection filter
5	Pr1.04	1 st torque filter time constant
6	Pr1.05	2 nd position loop gain
7	Pr1.06	2 nd velocity loop gain
8	Pr1.07	2 nd velocity integral time constant
9	Pr1.08	2 nd velocity detection filter
10	Pr1.09	2 nd torque filter time constant
11	Pr1.10	Velocity feedforward gain constant
12	Pr1.11	Velocity feedforward filter time constant
13	Pr1.12	Torque feedforward gain
14	Pr1.13	Torque feedforward filter time constant
15	Pr1.15	Position control gain switching mode
16	Pr1.17	Position control switching level
17	Pr1.18	Position control switching hysteresis
18	Pr1.19	Position gain switching time

1st and 2nd gain initial values are obtained by automatic gain adjustment

No.	Parameter	Label
1	Pr1.00	1 st position loop gain
2	Pr1.01	1 st velocity loop gain
3	Pr1.02	1 st velocity integral time constant
4	Pr1.03	1 st velocity detection filter
5	Pr1.04	1 st torque filter time constant
6	Pr1.05	2 nd position loop gain
7	Pr1.06	2 nd velocity loop gain
8	Pr1.07	2 nd velocity integral time constant
9	Pr1.08	2 nd velocity detection filter
10	Pr1.09	2 nd torque filter time constant

Manually adjusted gain parameters

No.	Parameter	Label
1	Pr1.00	1 st position loop gain
2	Pr1.01	1 st velocity loop gain
3	Pr1.02	1 st velocity integral time constant
4	Pr1.04	1 st torque filter time constant
5	Pr1.10	Velocity feedforward gain constant
6	Pr1.11	Velocity feedforward filter time constant

Velocity control mode

Velocity control mode parameters adjustment is pretty similar to position control mode. Except for position loop gain Pr1.00 and Pr1.05, velocity feedforward gain (Pr1.10)

Torque control mode

Parameters adjustment for torque control mode has to be differentiate into 2 conditions:

1. When actual velocity reaches velocity limit, adjustment will be as per velocity control mode. Motor will switch from torque control to velocity limit as velocity control.
2. When actual velocity doesn't reach velocity limit yet, Except for position loop gain, velocity loop gain and feedforward gain, parameter adjustments as per velocity control mode.

If there is no velocity limit and control is through torque command, please deactivate torque and notch filter, set velocity limit to max. value and increase velocity loop gain to as high as possible.

5.4.2 Gain switching

Gain switching function can be triggered internally in servo driver. Only valid under position or velocity control mode. Following effects can be realized by gain switching:

1. Switch to lower gain when motor stops to suppress vibration
2. Switch to higher gain when motor is moving at a low velocity to shorten positioning time
3. Switch to higher gain when motor is moving at a high velocity to improve command following behavior.

Diagram below shows gain switching when motor stops.

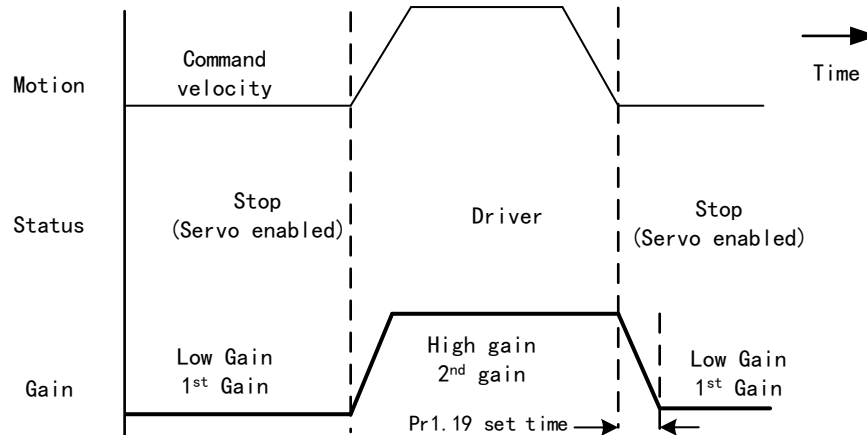

1st gain (Pr1.00-Pr1.04) and 2nd gain (Pr1.05-Pr1.09) switching can be realized through manual and positioning mode. Switching condition is set through Pr1.15. Gain switching is invalid under standard mode.

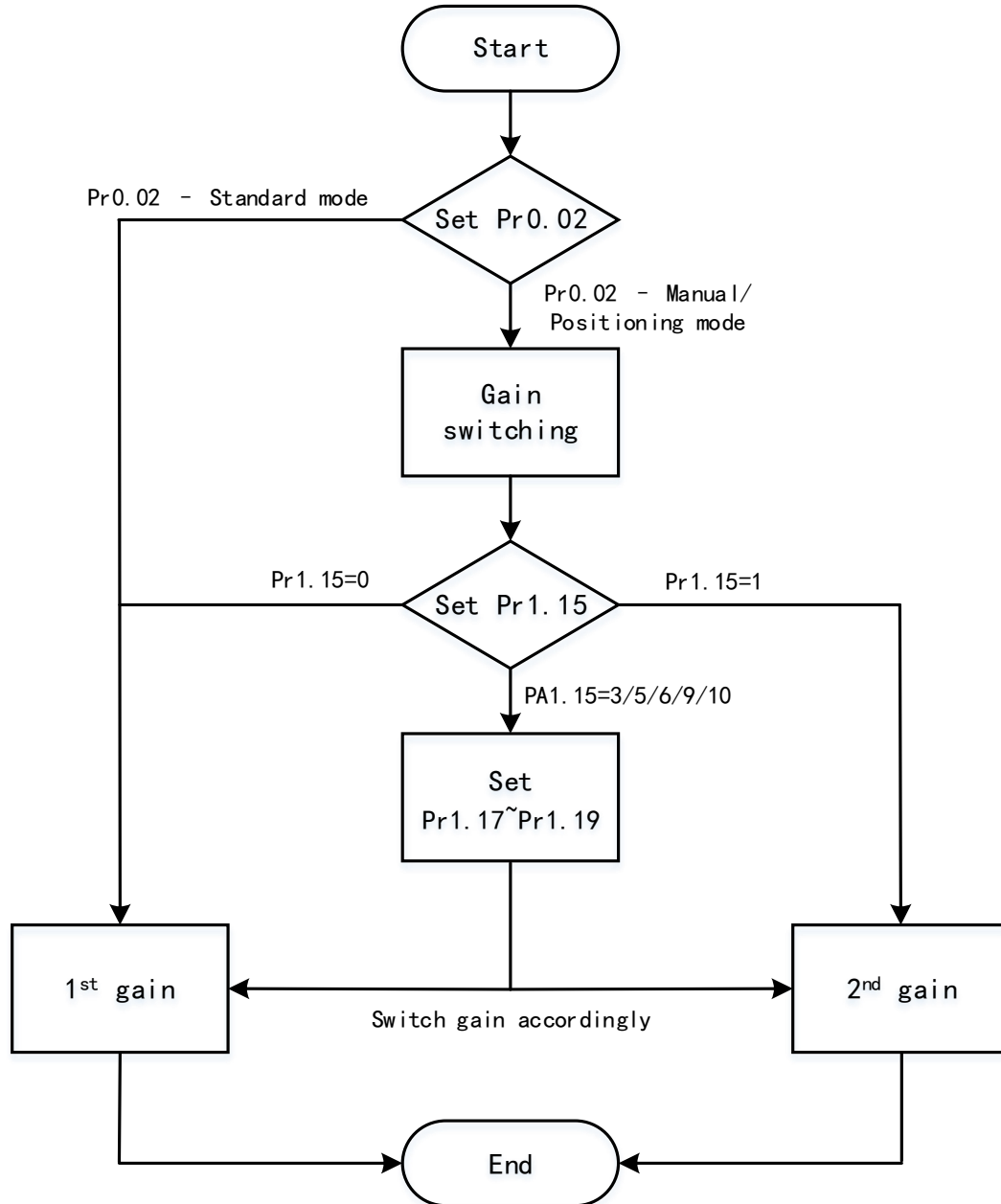
Related parameters on gain switching

No.	Parameter	Label	Remarks
1	Pr1.15	Position control gain switching mode	In position control, set Pr1.15=3、5、6、9、10. In velocity control, set Pr1.15=3、5、9
2	Pr1.17	Position control level switching	Please set Pr1.17≥Pr1.18
3	Pr1.18	Position control hysteresis switching	If Pr1.17<Pr1.18, driver will set Pr1.17=Pr1.18
4	Pr1.19	Position gain time switching	As shown below

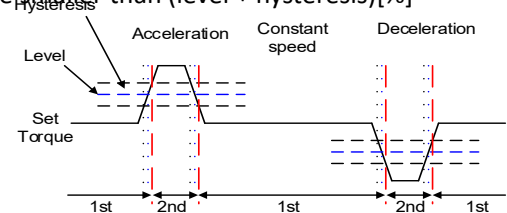
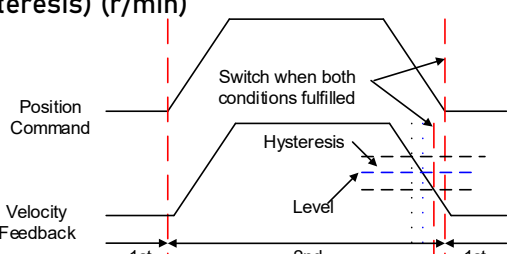
Pr1.15	Label	Position control gain switching mode		Valid mode(s)	P	
	Range	0~10	Unit	—	Default	0
	Byte length	16bit	Attribute	R/W	485 address	0x011F
	Valid	Immediate				
In position control, set the conditions for gain switching to be valid.						
	Value	Condition	Gain switching condition			
	【0】	1 st gain fixed	Fixed on using 1 st gain(Pr1.00-Pr1.04)			
	1	2 nd gain fixed	Fixed on using 2 nd gain (Pr1.05-Pr1.09)			
	2	Gain switching input valid	· Gain switching input (GAIN) invalid: 1 st gain. · Gain switching input (GAIN) valid: 2 nd gain. *Default: 1 st gain			
	3	High command torque	Switch to 2 nd gain when set torque command absolute value larger than (level + hysteresis)[%] Switch to 1 st gain when set torque command absolute value smaller than (level + hysteresis)[%] 			
	4-9	Reserved	Reserved			
	10	Pending position command +actual velocity	Valid for position control. Switch to 2 nd gain if position command $\neq 0$ Switch to 1 st gain if positional command = 0 throughout the duration of delay time and absolute value of actual velocity remains smaller than (level - hysteresis) (r/min) 			
** Above 'level' and 'hysteresis' are in correspondence to Pr1.17 Position control gain switching level and Pr1.18 Hysteresis at position control switching.						
Pr1.17	Label	Position control gain switching level		Valid mode(s)	P	
	Range	0~20000	Unit	Mode dependent	Default	50
	Byte length	16bit	Attribute	R/W	485 address	0x0123
	Valid	Immediate				

Set threshold value for gain switching to occur.
Unit is mode dependent.

Switching condition	Unit
Position	Encoder pulse count
Velocity	RPM
Torque	%

Please set level \geq hysteresis

Pr1.18	Label	Hysteresis at position control switching		Valid mode(s)	P		
	Range	0~20000	Unit	Mode dependent	Default	33	
	Byte length	16bit	Attribute	R/W	485 address	0x0125	
	Valid	Immediate					

To eliminate the instability of gain switching. Used in combination with Pr1.17 using the same unit.

If level < hysteresis, drive will set internally hysteresis = level.

Pr1.19	Label	Position control switching time		Valid mode(s)	P		
	Range	0~10000	Unit	0.1ms	Default	33	
	Byte length	16bit	Attribute	R/W	485 address	0x0127	
	Valid	Immediate					

During position control, if 1st and 2nd gain difference is too large, to ease torque changes and vibration due to rapid changes in position loop gain, set suitable Pr1.19 value

For example: 1st (pr1.00) <-> 2nd (Pr1.05)

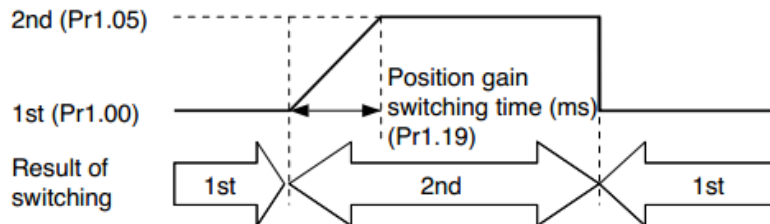

5.5 3rd gain switching

Besides switching between 1st and 2nd gain, a 3rd gain switching is added to set gain at the moment of stopping to reduce positioning time.

Only available under position mode and Pr6.05 ≠ 0, set Pr6.06 for 3rd gain value. When 2nd gain switches to 1st gain, it has to go through 3rd gain, switching time is set in Pr1.19.

Diagram below shows when Pr1.15 = 7.

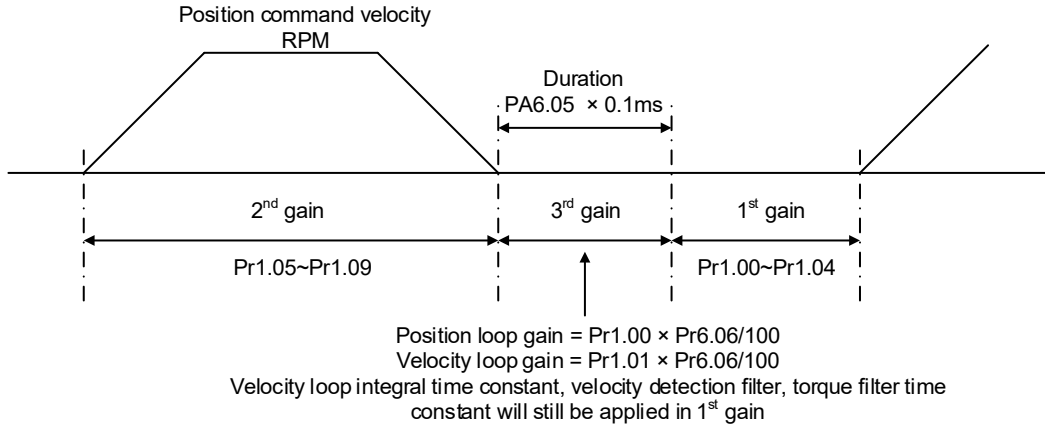

Related parameters

Pr6.05	Label	Position 3 rd gain valid time			Valid mode(s)	P
	Range	0~10000	Unit	0.1ms	Default	0
	Byte length	16bit	Attribute	R/W	485 address	0x060B
	Valid	Immediate				

To set time for 3rd gain to be valid
 Only available in position mode
 When not in use, set Pr6.05=0, Pr6.06=100

Pr6.06	Label	Position 3 rd gain scale factor			Valid mode(s)	P
	Range	50~1000	Unit	100%	Default	100
	Byte length	16bit	Attribute	R/W	485 address	0x060D
	Valid	Immediate				

Set up the 3rd gain by multiplying factor of the 1st gain

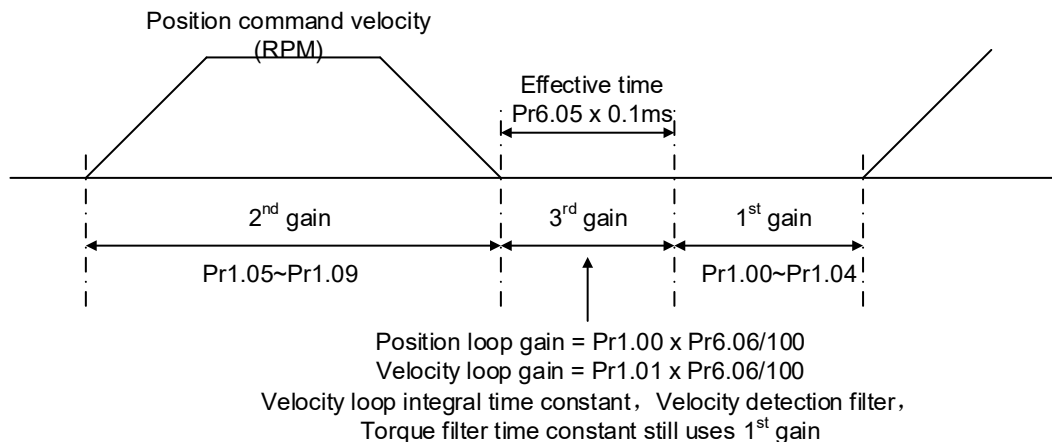

Above diagram is illustrated using Pr1.15 = 7.

$3^{\text{rd}} \text{ gain} = 1^{\text{st}} \text{ gain} * \text{Pr6.06}/100$

Only effective under position control mode. 3^{rd} gain valid when Pr6.05 \neq 0. Set 3^{rd} gain value in Pr6.06. When 2^{nd} gain switches to 1^{st} gain, it will go through 3^{rd} , switching time is set in Pr1.19.

5.6 Model following control

Model following control is a type of closed loop control system. First, an ideal model is constructed and acts as a reference for actual model in a closed loop control. Model following control can be treated as a control mode with 2 flexibilities: Model reference can be used to improve command responsiveness and closed loop control used to increase responsiveness of the system towards interference. They don't affect each other.

Model following control can be used in position loop control to increase responsiveness to commands, reduce positioning time and following error. This function is only available in position control mode.

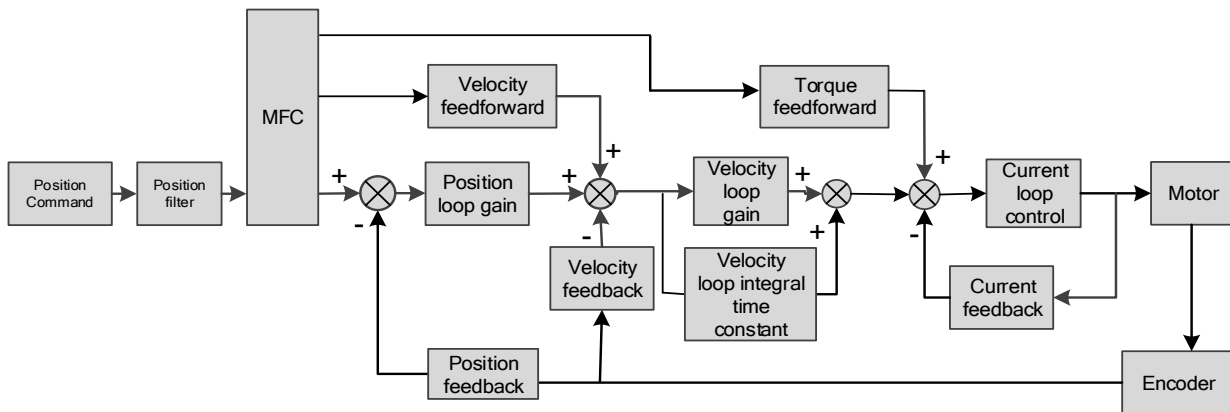

To adjust model following control

1. Automatic adjustment
Set model following bandwidth Pr0.00 = 1 for automatic adjustment. Now, Pr0.00 = Pr1.01, model following bandwidth is adjusted automatically according to different velocity loop gain.
3. Manual adjustment
Please use manual adjustment if
 - Automatic adjustment is not satisfactory.
 - Responsiveness needs further improvement in comparison with automatic adjustment.
 - There is a need to set servo gain or model following control parameters manually.

Steps to manually adjust

Step	Content
1	Set up vibration suppression.
2	Set up the right inertia ratio.
3	Manually adjust gain.
4	Increase Pr0.00 provided that there is no overshoot and vibration. Usually Pr0.00 \geq Pr1.01 is recommended.

Model following bandwidth determines the responsiveness of the servo system. Increase the value set will increase responsiveness and reduce positioning time. Overshoot can be prevented if it is set at a lower value but responsiveness will be lowered. Model following bandwidth shouldn't be too large for mechanical structure with lower stiffness, excessive position deviation alarm might occur under high velocity.

5.7 Feedforward gain

In position control, velocity feedforward is calculated by comparing the velocity control command calculated internally and velocity command calculated from position feedback. Comparing to control only using feedbacks, this will reduce position deviation and increase responsiveness. Besides, by comparing the torque needed during motion from velocity control command in comparison with velocity feedback, torque feedback can be calculated to improve system responsiveness.

5.7.1 Velocity feedforward

Velocity feedforward can be used in position control mode. When the function is enabled, it can increase velocity responsiveness, reduce position deviation during constant velocity.

Pr1.10	Label	Velocity feed forward gain			Valid mode(s)	P		
	Range	0~1000	Unit	0.10%	Default	300		
	Byte length	16bit	Attribute	R/W	485 address	0x0115		
	Valid	Immediate						
Used for decreasing following error caused by low responsiveness of velocity loop. Might cause overshoot or increase in noise if set value is too high.								
Pr1.11	Label	Velocity feed forward filter time constant			Valid mode(s)	P		
	Range	0~6400	Unit	0.01ms	Default	50		
	Byte length	16bit	Attribute	R/W	485 address	0x0117		
	Valid	Immediate						
<p>Set velocity feed forward low pass filter to eliminate high or abnormal frequencies in velocity feed forward command. Often used when position command with low resolution or high electronic gear ration to smoothen velocity feed forward.</p> <p>Position deviation under constant velocity can be lowered with higher velocity feed forward gain. Please to refer to the equation below.</p> <p>Reduce Pr1.11 value to suppress velocity overshoot during deceleration; Increase Pr1.11 value to suppress noise or vibration due to long driver control cycle or position command uneven pulse frequency.</p> <p><Application></p> <p>Set Pr1.11 = 50 (0.5ms) , improve feedforward effect by gradually increase Pr1.10. The equation below can be used to determine the position deviation due to velocity feedforward gain under constant velocity.</p> $\text{Position deviation[Uint]} = \frac{\text{Set velocity}[\frac{\text{Uint}}{\text{s}}]}{\text{Position loop gain[Hz]} } \times \frac{100 - \text{Velocity feed foward gain}[\%]}{100}$								

Velocity feedforward application

Set Pr1.11 to around 50 (0.5ms), then tune Pr1.10 from 0 to bigger values until the velocity feedforward achieves better performance. Under constant velocity, the position deviation in a motion will decrease as the velocity feedforward gain increase.

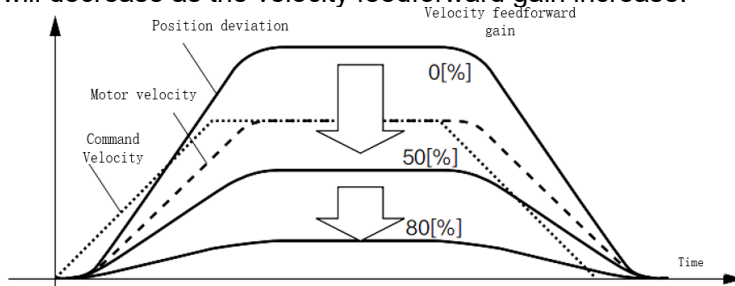

Steps to tuning:

1. Increase Pr1.10 to increase responsiveness but velocity overshoot might occur during acc-/deceleration.
2. By reducing Pr1.11, velocity feedforward would be more effective and vice versa. Pr1.10 and Pr1.11 need to be tuned to a balance.
3. If mechanical noise exists under normal working conditions, please increase Pr1.11 or use position command filter (1 time delay/ FIR smoothing filter)

5.7.2 Torque feedforward

Position control mode: Torque feedforward can increase the responsiveness of torque command, decrease position deviation during constant acc-/deceleration.

Velocity control mode: Torque feedforward can increase the responsiveness of torque command, decrease velocity deviation during constant velocity.

Pr1.12	Label	Torque feed forward gain			Valid mode(s)	P	S	
	Range	0~1000	Unit	0.1%	Default	0		
	Byte length	16bit	Attribute	R/W	485 address	0x0119		
	Valid	Immediate						
Before using torque feed forward, please set correct inertia ratio Pr0.04. By increasing torque feed forward gain, position deviation on constant acceleration/deceleration can be reduced to close to 0. Under ideal condition and trapezoidal speed profile, position deviation of the whole motion can be reduced to close to 0. In reality, perturbation torque will always exist, hence position deviation can never be 0.								
Pr1.13	Label	Torque feed forward filter time constant			Valid mode(s)	P	S	
	Range	0~6400	Unit	0.01ms	Default	0		
	Byte length	16bit	Attribute	R/W	485 address	0x011B		
	Valid	Immediate						
Low pass filter to eliminate abnormal or high frequencies in torque feed forward command. Usually used when encoder has lower resolution or precision. Noise reduces if torque feed forward filter time constant is set higher but position deviation will increase at acceleration varied points. <Application> <ul style="list-style-type: none"> • Set Pr1.13 = 50ms, please increase torque forward gain gradually to enable torque feedforward. • By increasing Pr1.13, noise will reduce but position deviation will become larger. 								

Torque feedforward application

Set Pr1.13 to around 50 (0.5ms), then tune Pr1.10 from 0 to bigger values until torque feedforward achieves better performance. Under constant acc-/deceleration, the position deviation in a motion will decrease as the velocity feedforward gain increase.

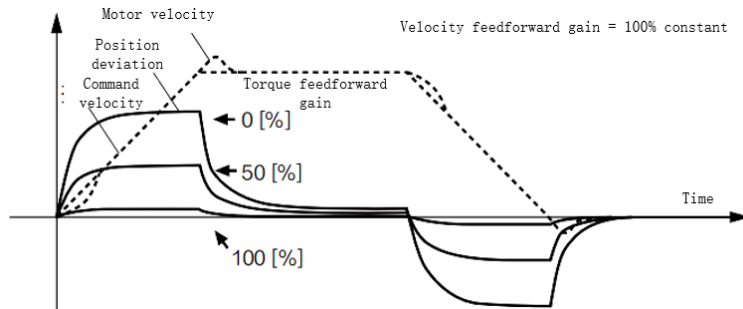

Steps to tuning:

3. Increase Pr1.12 to increase responsiveness but velocity overshoot might occur during acc-/deceleration.
4. By reducing Pr1.13, torque feedforward would be more effective and vice versa. Pr1.12 and Pr1.13 need to be tuned to a balance and reduce noise.

5.8 Friction compensation function

This function is to compensation for changes in load to reduce the effect of friction in motion. The compensation value is directional.

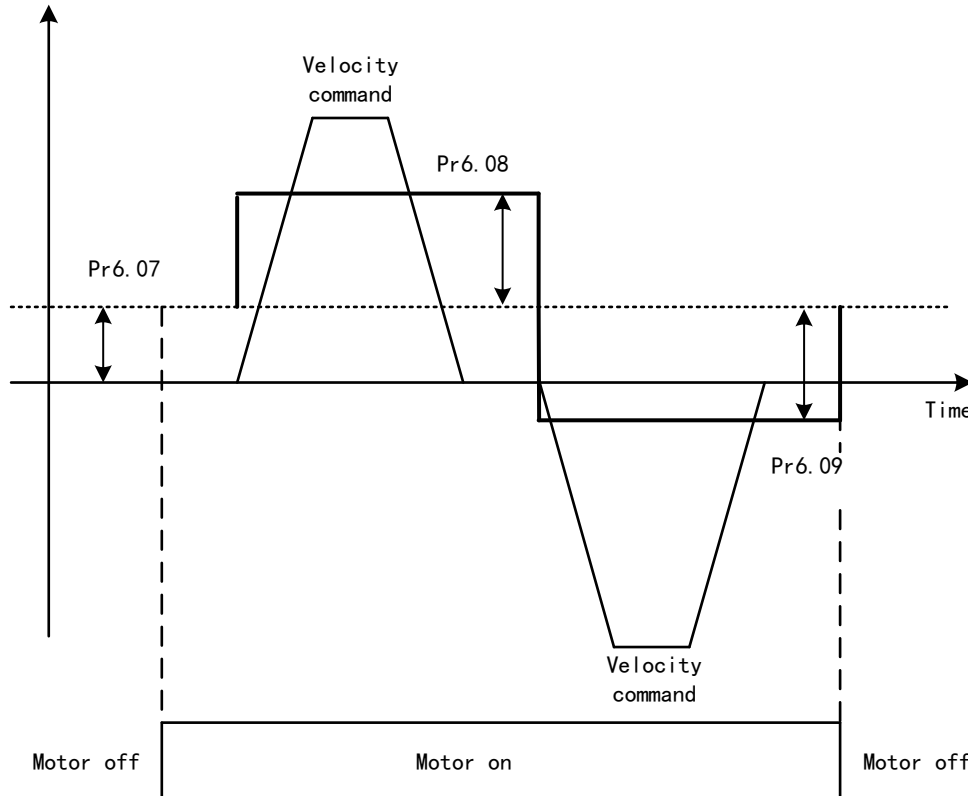

Vertically loaded axis: A constant eccentric load torque is applied on the motor. By adjusting Pr6.07, positioning deviation due to different motional direction can be reduced.

Belt-driven axis: Due to large radial load with dynamic frictional torque. Positioning time delay and deviation can be reduced by adjusting Pr6.08 and Pr6.09.

Pr6.07	Label	Torque command additional value			Valid mode(s)	P	S	T
	Range	-100~100	Unit	%	Default	0		
	Byte length	16bit	Attribute	R/W	485 address	0x060F		
	Valid	Immediate						
To set torque forward feed additional value of vertical axis. Applicable for loaded vertical axis, compensate constant torque. Application: When load move along vertical axis, pick any point from the whole motion and stop the load at that particular point with motor enabled but not rotating. Record output torque value from d04, use that value as torque command additional value (compensation value)								
Pr6.08	Label	Positive direction torque compensation value			Valid mode(s)	P	S	T
	Range	-100~100	Unit	%	Default	0		
	Byte length	16bit	Attribute	R/W	485 address	0x0611		
	Valid	Immediate						
Pr6.09	Label	Negative direction torque compensation value			Valid mode(s)	P	S	T

	Range	-100~100	Unit	%	Default	0
	Byte length	16bit	Attribute	R/W	485 address	0x0613
	Valid	Immediate				

To reduce the effect of mechanical friction in the movement(s) of the axis. Compensation values can be set according to needs for both rotational directions.

Applications:

- When motor is at constant speed, d04 will deliver torque values.
Torque value in positive direction = T1;
Torque value in negative direction = T2

$$\text{Pr6.08/Pr6.09} = T_f = \frac{|T1 - T2|}{2}$$

Positive/Negative compensation corresponds to actual position feedback.
Positive torque compensation value = +(Pr6.08=+T_f)
Negative torque compensation value = -(Pr6.08=+T_f)
Pr6.08 =x, Pr6.09=y; friction compensation value = |x-y|/2

5.9 Safety Functions

5.9.1 Max. motor rotational speed limitation

Motor rotational speed limits can be set on Pr3.24. If command speed is 1500r/min, but Pr3.24 is set to 1000r/min, motor rotational speed will only go up to 1000r/min.

Motor overspeed threshold value can be set in Pr5.13, if the rotational speed is exceeded during operation, Er1A0 might occur.

Pr3.24	Label	Maximum motor rotational speed			Valid mode(s)	P	S	T
	Range	0~10000	Unit	r/min	Default	0		
	Byte length	16bit	Attribute	R/W	485 address	0x0331		
	Valid	Immediate						

To set maximum motor rotational speed but not higher than motor rated speed
 If Pr3.24 = 0, maximum motor rotational speed = max. speed in motor parameter.

Pr5.13	Label	Overspeed level settings			Valid mode(s)	P	S	T
	Range	0~10000	Unit	r/min	Default	0		
	Byte length	16bit	Attribute	R/W	485 address	0x051B		
	Valid	Immediate						

If motor speed exceeds Pr5.13, Er1A0 might occur.
 When Pr5.13 = 0, overspeed level = max. motor speed x 1.2

5.9.2 Max. duration for motor to stop after disabling

Set max time duration for motor to stop after disabling. If the time taken for motor to stop exceeds the duration set in Pr6.14 and motor speed is still higher than Pr4.39, holding brake will be activated. If motor doesn't have holding brake, dynamic braking will be activated to force stop the motor.

Pr6.14	Label	Max. time to stop after disabling			Valid mode(s)	P	S	T
	Range	0~1000	Unit	ms	Default	500		
	Byte length	16bit	Attribute	R/W	485 address	0x061D		
	Valid	Immediate						

To set the max. time allowed for the axis to stop on emergency stop or normal axis disabling. After disabling axis, if motor speed is still higher than Pr4.39 but the time set in Pr6.14 is reached, BRK_ON given and holding brake activated. BRK_ON given time is determined by Pr6.14 or when motor speed goes below Pr4.39, whichever comes first.

Applications:

1. After disabling axis, if motor speed is still higher than Pr4.39 but the time set in Pr6.14 is reached, BRK_ON given and holding brake activated.
2. After disabling axis, if motor speed is already lower than Pr4.39 but the time set in Pr6.14 is not yet reached, BRK_ON given and holding brake activated.

Dynamic brake will be provide the braking function if the function is activated for motors without holding brake.

5.9.3 External brake deactivation output signal BRK-OFF

Please refer to Pr4.11 to set up the I/O output function parameters. When enabled and timing conditions are fulfilled, the set I/O output will deliver ON signal.

Pr4.37	Label	Holding brake deactivation delay time			Valid mode(s)	P	S	T
	Range	0~3000	Unit	1ms	Default	150		
	Byte length	16bit	Attribute	R/W	485 address	0x044B		
	Valid	Immediate						

To set delay time for holding brake to be activated after motor power off to prevent axis from sliding. When Pr5.06 = 0, SRV-ON signal is off, holding brake is activated (delay time is determined by Pr4.39 or Pr6.14). Motor powered-off once delay time set in Pr4.37 is due.

Pr4.38	Label	Holding brake activation delay time			Valid mode(s)	P	S	T
	Range	0~3000	Unit	1ms	Default	0		
	Byte length	16bit	Attribute	R/W	485 address	0x044D		
	Valid	Immediate						

To set delay time for holding brake to be released after motor power on. Motor will remain at current position and input command is masked to allow holding brake to be fully released before motor is set in motion.

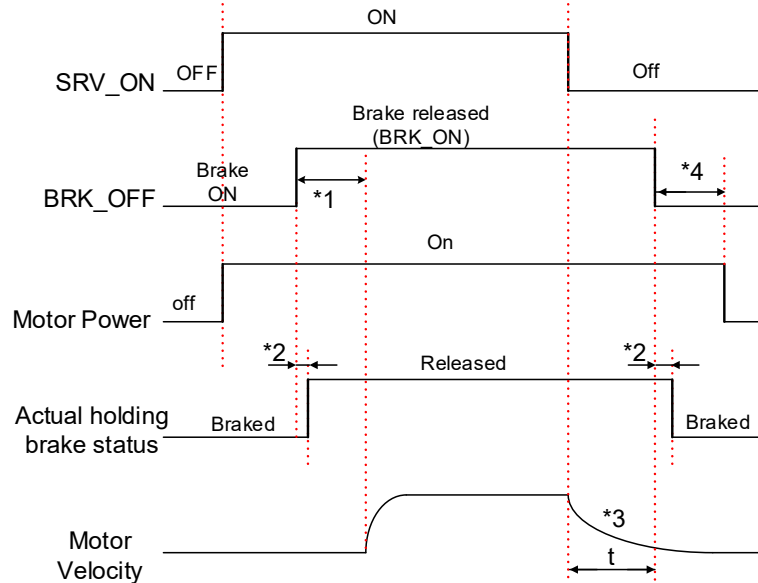

*1: Delay time set in Pr4.38

*2: Delay time from the moment BRK_OFF signal is given until actual holding brake is released or BRK_ON signal is given until actual holding brake is activated. It is dependent on the holding brake of the motor.

*3: Deceleration time is determined by Pr6.14 or if motor speed goes below Pr4.39, whichever comes first. BRK_OFF given after deceleration time.

*4: Pr4.37 set time value.

Delay time from the moment SRV_ON is given until BRK_OFF switch to BRK_ON, is less than 500ms.

Pr4.39	Label	Holding brake activation speed		Valid mode(s)	P	S	T
	Range	30~3000	Unit	r/min	Default	30	
	Byte length	16bit	Attribute	R/W	485 address	0x044F	
	Valid	Immediate					

To set the activation speed for which holding brake will be activated.

When SRV-OFF signal is given, motor decelerates, after it reaches below Pr4.39 and Pr6.14 is not yet reached, BRK_OFF is given.

BRK_OFF signal is determined by Pr6.14 or if motor speed goes below Pr4.39, whichever comes first.

Application:

1. After disabling axis, Pr6.14 has been reached but motor speed is still above Pr4.39, BRK_OFF signal given.
2. After disabling axis, Pr6.14 has not been reached but motor speed is below Pr4.39, BRK_OFF signal given.

Deceleration max duration: 2s. Servo disabled after 2s.

5.9.4 Servo stopping mode

Pr5.06	Label	Servo-off mode			Valid mode(s)	P	S	T
	Range	0~1	Unit	—	Default	0		
	Byte length	16bit	Attribute	R/W	485 address	0x050D		
	Valid	Immediate						
To set servo driver disable mode and status.								
Set value		Explanation						
0		Driver disables after velocity reaching value set in Pr4.39						
1		Driver disables immediately, axis in free stopping mode						

5.9.5 Emergency stop function

Emergency stop is used when an alarm occurs or a servo prohibition signal is received when servo driver is enabled.

Method 1: Set up Pr4.43 to enable the function

Pr4.43	Label	Emergency stop function			Valid mode(s)	P	S	T
	Range	0~1	Unit	—	Default	0		
	Byte length	16bit	Attribute	R/W	485 address	0x0457		
	Valid	Immediate						
Value		Description.						
【0】		Emergency stop is valid, servo driver will be forced to STOP and Err570 occurs.						
1		Emergency stop is invalid, servo driver will not be forced to STOP. Servo can be enabled once E-STOP signal is cleared.						
Pr5.04	Label	Driver prohibition input settings			Valid mode(s)	P	S	T
	Range	0/1/2	Unit	—	Default	0		
	Byte length	16bit	Attribute	R/W	485 address	0x0509		
	Valid	Immediate						
To set driver prohibition input (POT/NOT)								
Value		Description						
0		POT → Positive direction drive prohibited NOT → Negative direction drive prohibited						
1		POT and NOT invalid						
2		Any single sided input from POT or NOT might cause Er260						

Method 2: Using RS485 address through master device to activate this function.

Pr5.11	Label	Servo braking torque setting			Valid mode(s)	P	S	T
	Range	0~500	Unit	%	Default	0		
	Byte length	16bit	Attribute	R/W	485 address	0x0517		
	Valid	Immediate						
To set torque limit for servo braking mode. If Pr5.11 = 0, use torque limit as under normal situation.								

Please note that if Pr5.11 set value is too low, emergency stop will take longer.

5.10 Vibration Suppression

5.10.1 Mechanical resonance suppression

Mechanical system has certain resonance frequencies. When servo gain is increased, resonance might occur at around mechanical resonant frequencies, preventing gain value from increasing. In such situation, notch filter can be used to suppress resonance to set higher gains or lower vibration.

To suppress mechanical resonance:

1. Torque command filter time constant
Set filter time constant to reduce gain at around resonant frequencies
Torque command filter blocked frequencies (Hz) $f_c = 1 / [2\pi \times Pr1.04(0.01ms) \times 0.00001]$
2. Notch filter
Notch filter suppress mechanical resonance by reducing gain at certain frequencies. When notch filter is correctly set, resonance can be suppressed and servo gain can be increased.

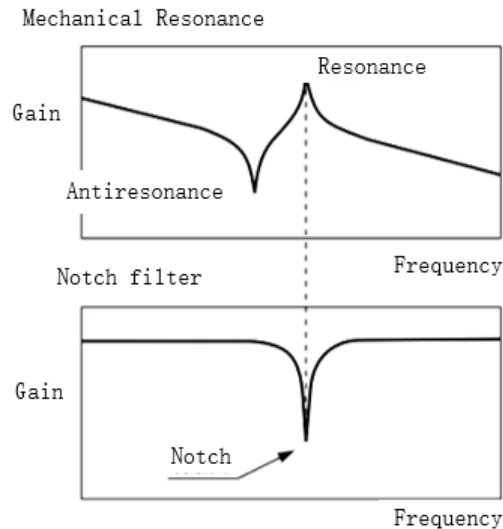

- Notch filter bandwidth
Center frequency of the notch filter, frequency bandwidth with reduction of -3dB.
- Notch filter depth
The ratio between input and output of center frequency.
When depth = 0, center frequency output is totally off and when depth = 100,
Hence when notch filter depth is set at lower value, the depth is higher and better at suppressing mechanical resonance but it might cause system instability.

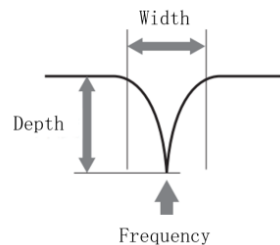

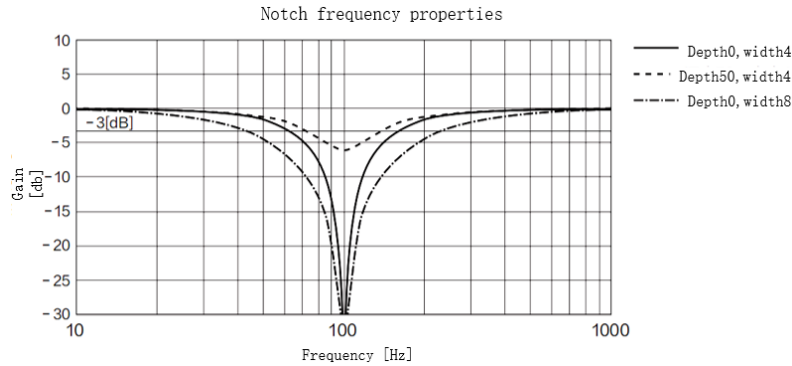

If the analytic result from mechanical properties analysis tool doesn't show any obvious peak but vibration did occur, it might not be due to mechanical resonance, it may be that servo gain has reached its limit. This kind of vibration can't be suppressed by using notch filter, only by reducing gain and torque command filter time.

To use notch filter

Automatic notch filter

1. Set Pr2.00 = 1 for auto notch filter adjustment
2. If Pr0.03 stiffness increases, 3rd group of notch filter (Pr2.07/Pr2.08/Pr2.09) updates automatically when driver is enabled. Pr2.00 = 0, auto adjustments stop.
If resonance is suppressed, it means self-adjusting notch filter is working. If resonance occurs when mechanical stiffness increases, please use manual notch filter, set filter frequency to actual resonant frequency.

Manual notch filter

There are 2 ways to use manual notch filter.

1. After enabling self-adjusting notch filter, set the values from 3rd group of filters to 1st group of notch filter (Pr2.01/Pr2.02/Pr2.03), see if resonance is suppressed. If there is other resonance, set Pr2.00 = 1, then set the values from 3rd group of filters to 2nd group of notch filter (Pr2.04/Pr2.05/Pr2.06)
2. Get resonant frequency, notch filter bandwidth and depth and set it into the corresponding parameters through Motion Studio.

Pr2.00	Label	Adaptive filtering mode settings			Valid mode(s)	P	S																
	Range	0~4	Unit	—	Default	0																	
	Byte length	16bit	Attribute	R/W	485 address	0x0201																	
	Valid	Immediate																					
<table border="1"> <thead> <tr> <th>Value</th> <th colspan="2">Description</th> </tr> </thead> <tbody> <tr> <td>0</td> <td>Adaptive filter: invalid</td> <td>Parameters related to 3rd notch filter remain unchanged</td> </tr> <tr> <td>1</td> <td>Adaptive filter: 1 filter valid for once.</td> <td>1 adaptive filter becomes valid. 3rd notch filter related parameters updated accordingly. Pr2.00 switches automatically to 0 once updated.</td> </tr> <tr> <td>2</td> <td>Adaptive filter: 1 filter remains valid</td> <td>1 adaptive filter becomes valid. 3rd notch filter related parameters will keep updating accordingly.</td> </tr> <tr> <td>3-4</td> <td>Reserved</td> <td>-</td> </tr> </tbody> </table>									Value	Description		0	Adaptive filter: invalid	Parameters related to 3 rd notch filter remain unchanged	1	Adaptive filter: 1 filter valid for once.	1 adaptive filter becomes valid. 3 rd notch filter related parameters updated accordingly. Pr2.00 switches automatically to 0 once updated.	2	Adaptive filter: 1 filter remains valid	1 adaptive filter becomes valid. 3 rd notch filter related parameters will keep updating accordingly.	3-4	Reserved	-
Value	Description																						
0	Adaptive filter: invalid	Parameters related to 3 rd notch filter remain unchanged																					
1	Adaptive filter: 1 filter valid for once.	1 adaptive filter becomes valid. 3 rd notch filter related parameters updated accordingly. Pr2.00 switches automatically to 0 once updated.																					
2	Adaptive filter: 1 filter remains valid	1 adaptive filter becomes valid. 3 rd notch filter related parameters will keep updating accordingly.																					
3-4	Reserved	-																					
Pr2.01	Label	1 st notch frequency			Valid mode(s)	P	S	T															
	Range	50~4000	Unit	Hz	Default	4000																	
	Byte length	16bit	Attribute	R/W	485 address	0x0203																	
	Valid	Immediate																					
Set center frequency of 1 st torque command notch filter. Set Pr2.01 to 4000 to deactivate notch filter																							
Pr2.02	Label	1 st notch width			Valid mode(s)	P	S	T															
	Range	0~20	Unit	—	Default	4																	
	Byte length	16bit	Attribute	R/W	485 address	0x0205																	
	Valid	Immediate																					
Set notch bandwidth for 1 st resonant notch filter. Under normal circumstances, please use factory default settings. If resonance is under control, in combination with Pr2.01 and Pr2.03, Pr2.02 can be reduced to improve current loop responsiveness which allows higher mechanical stiffness settings																							
Pr2.03	Label	1 st notch depth			Valid mode(s)	P	S	T															
	Range	0~99	Unit	—	Default	0																	
	Byte length	16bit	Attribute	R/W	485 address	0x0207																	
	Valid	Immediate																					
Set notch depth for 1 st resonant notch filter. Under normal circumstances, please use factory default settings. If resonance is under control, in combination with Pr2.01 and Pr2.02, Pr2.03 can be reduced to improve current loop responsiveness which allows higher mechanical stiffness settings																							
Pr2.04	Label	2 nd notch frequency			Valid mode(s)	P	S	T															
	Range	50~4000	Unit	Hz	Default	4000																	
	Byte length	16bit	Attribute	R/W	485 address	0x0209																	
	Valid	Immediate																					
Set center frequency of 2 nd torque command notch filter. Set Pr2.04 to 4000 to deactivate notch filter																							
Pr2.05	Label	2 nd notch width			Valid mode(s)	P	S	T															
	Range	0~20	Unit	—	Default	4																	
	Byte length	16bit	Attribute	R/W	485 address	0x020B																	
	Valid	Immediate																					

<p>Set notch bandwidth for 2nd resonant notch filter. Under normal circumstances, please use factory default settings. If resonance is under control, in combination with Pr2.04 and Pr2.06, Pr2.05 can be reduced to improve current loop responsiveness which allows higher mechanical stiffness settings.</p>								
Pr2.06	Label	2 nd notch depth			Valid mode(s)	P	S	T
	Range	0~99	Unit	—	Default	0		
	Byte length	16bit	Attribute	R/W	485 address	0x020D		
	Valid	Immediate						
<p>Set notch depth for 1st resonant notch filter. When Pr2.06 value is higher, notch depth becomes shallow, phase lag reduces. Under normal circumstances, please use factory default settings. If resonance is under control, in combination with Pr2.04 and Pr2.05, Pr2.06 can be reduced to improve current loop responsiveness which allows higher mechanical stiffness settings.</p>								
Pr2.07	Label	3 rd notch frequency			Valid mode(s)	P	S	T
	Range	50~4000	Unit	Hz	Default	4000		
	Byte length	16bit	Attribute	R/W	485 address	0x020F		
	Valid	Immediate						
<p>Set center frequency of 3rd torque command notch filter. Set Pr2.07 to 4000 to deactivate notch filter</p>								
Pr2.08	Label	3 rd notch width			Valid mode(s)	P	S	T
	Range	0~20	Unit	—	Default	4		
	Byte length	16bit	Attribute	R/W	485 address	0x0211		
	Valid	Immediate						
<p>Set notch depth for 3rd resonant notch filter. When Pr2.06 value is higher, notch depth becomes shallow, phase lag reduces. Under normal circumstances, please use factory default settings. If resonance is under control, in combination with Pr2.04 and Pr2.05, Pr2.06 can be reduced to improve current loop responsiveness which allows higher mechanical stiffness settings.</p>								
Pr2.09	Label	3 rd notch depth			Valid mode(s)	P	S	T
	Range	0~99	Unit	—	Default	0		
	Byte length	16bit	Attribute	R/W	485 address	0x0213		
	Valid	Immediate						
<p>Set notch depth for 3rd resonant notch filter. When Pr2.06 value is higher, notch depth becomes shallow, phase lag reduces. Under normal circumstances, please use factory default settings. If resonance is under control, in combination with Pr2.04 and Pr2.05, Pr2.06 can be reduced to improve current loop responsiveness which allows higher mechanical stiffness settings.</p>								

5.10.2 End vibration suppression

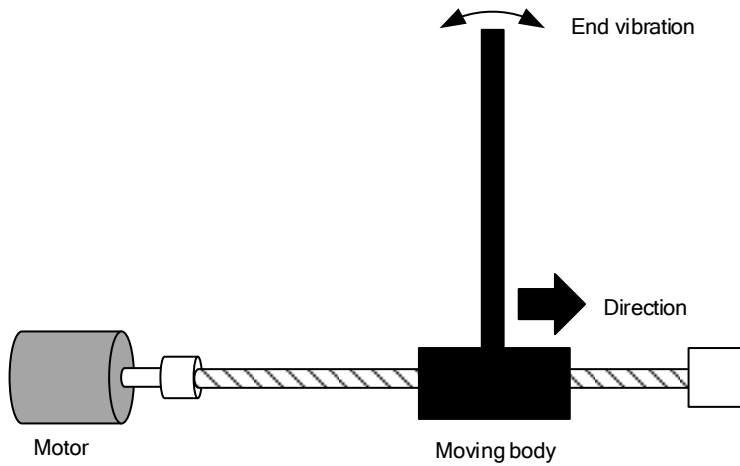

If the mechanical has an end that is long and heavy, it might cause end vibration at emergency stop and affect the positioning. Usually happens on long armed axis with loose end. The frequency is usually within 100Hz which is lower than mechanical resonant frequencies. It is called low-frequency resonance which can be prevented by applying low frequency suppression function.

To apply low frequency suppression

1. Trace current/ position deviation waveform when motion stops.
2. Measure the vibration cycle T_1 of current waveform.
3. Convert T_1 into low frequency resonance by $F_1 = 1/T_1$
4. Write F_1 into Pr2.14
5. If some other low frequency resonance occurs, please repeat step 1-3 and write F_2 into Pr2.16.

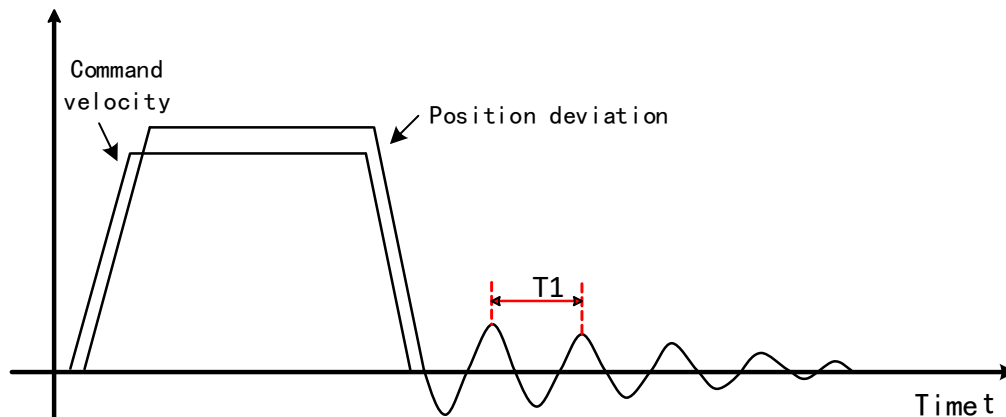

The result of suppressing low frequency resonance

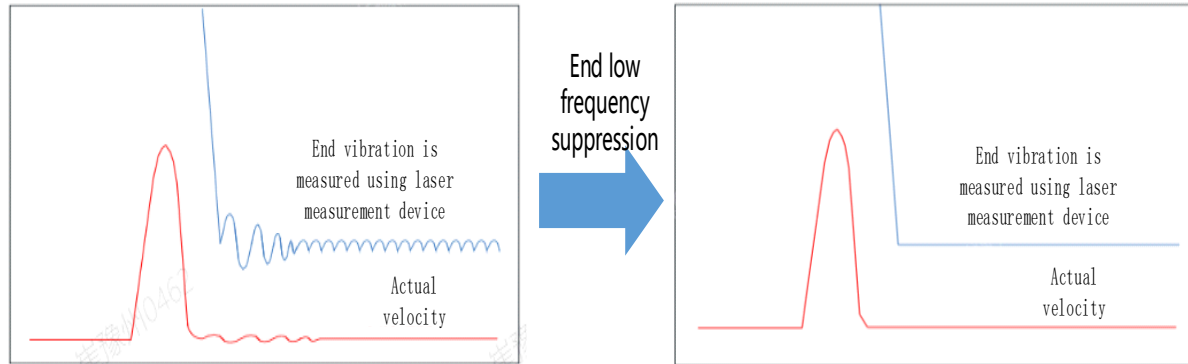

Pr2.14	Label	1 st damping frequency			Valid mode(s)	P	
	Range	0/10~2000	Unit	0.1Hz	Default	0	
	Byte length	16bit	Attribute	R/W	485 address	0x021D	
	Valid	Immediate					
Set Pr2.16 to 0 to deactivate this parameter. To suppress wobble at load end. Often used when wobble of flexible structure due to high deceleration upon stopping. Especially effective for wobble with frequencies under 100Hz. Set Pr2.15 to wobble frequency (wobble frequency can be determined using tracing function of Motion Studio)							
Pr2.16	Label	2 nd damping frequency			Valid mode(s)	P	
	Range	0/10~2000	Unit	0.1Hz	Default	0	
	Byte length	16bit	Attribute	R/W	485 address	0x0221	
	Valid	Immediate					
Set Pr2.16 to 0 to deactivate this parameter. To suppress wobble at load end. Often used when wobble of flexible structure due to high deceleration upon stopping. Especially effective for wobble with frequencies under 100Hz. Set Pr2.16 to wobble frequency (wobble frequency can be determined using tracing function of Motion Studio)							

5.11 Multiturn absolute encoder

Multiturn absolute encoder records the position and the revolution counts of the motor. When driver is powered-off, multiturn absolute encoder will backed up the data using battery and after powering on, the data will be used to calculated absolute mechanical position and there is no need for a mechanical homing process. Use widely in robotic arms and CNC machines.

If it is the first time using the encoder, please home the mechanical axis and initialize the absolute position of the encoder to zero. Set up a homing point and only home when there is an alarm. Please stop the axis before reading any position data to prevent inaccuracy.

5.11.1 Parameters setting

Pr0.15	Label	Absolute encoder settings			Valid mode(s)	P	S	T
	Range	0~15	Unit	-	Default	0		
	Byte length	16bit	Attribute	R/W	485 address	0x001F		

Value	Mode	Description
【0】	Incremental	Doesn't retain position data on power off. Unlimited travel distance.
1	Multiturn absolute linear	Retrain position data on power off. For applications with fixed travel distance and no multiturn data overflow.
2	Multiturn absolute rotary	Retrain position data on power off. Actual data feedback in between 0-(Pr6.63+1). Unlimited travel distance.
3	Single turn absolute	Used when travel distance is within 1 revolution of the encoder. Data overflow will trigger alarm.
5	Multi turn absolute	Clear multiturn alarm and activate multiturn absolute function. Will switch to multiturn mode once alarm cleared, if remains at 5 after 3s, please solve according to Er153.
9		Clear multiturn position, reset multiturn alarm and activate multiturn absolute function. Will switch to multiturn mode once alarm cleared, if remains at 9 after 3s, please solve according to Er153. Please disable axis before setting to 9 and home the axis before using.

5.11.2 Read absolute position

1、Steps:

- 1) First, select a motor with multiturn absolute encoder, install battery and confirm whether the driver version supports the specific motor;
- 2) Set Pr0.15 = 1. If it is the first time of installation, Err153 will occur because battery is newly installed and position data is invalid. Please home the axis and initialize the absolute position of the encoder to zero.
- 3) When absolute homing point is set and there is no fault with the battery, the alarm will be cleared
- 4) Finally, the user can read the absolute position. Position won't be lost even if the driver is powered off.

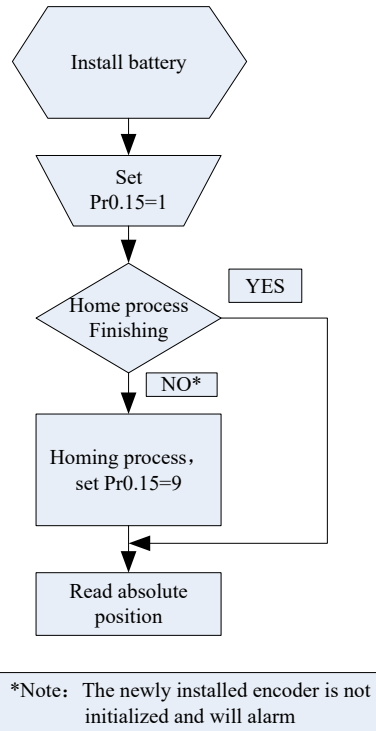

2、Read absolute position

When the rotor turns in clockwise direction, the revolution count will be negative; turns in counter clockwise direction, the count will be positive. No. of revolutions will be from -32767 to +32767. If the count number reaches +32767 in counter clockwise direction, the count will revert back to -32768, -32767 and vice versa for clockwise direction.

As for position data, it depends on the precision of the encoder. For 17 bit = 0-131071, 23 bit = 0-8388607

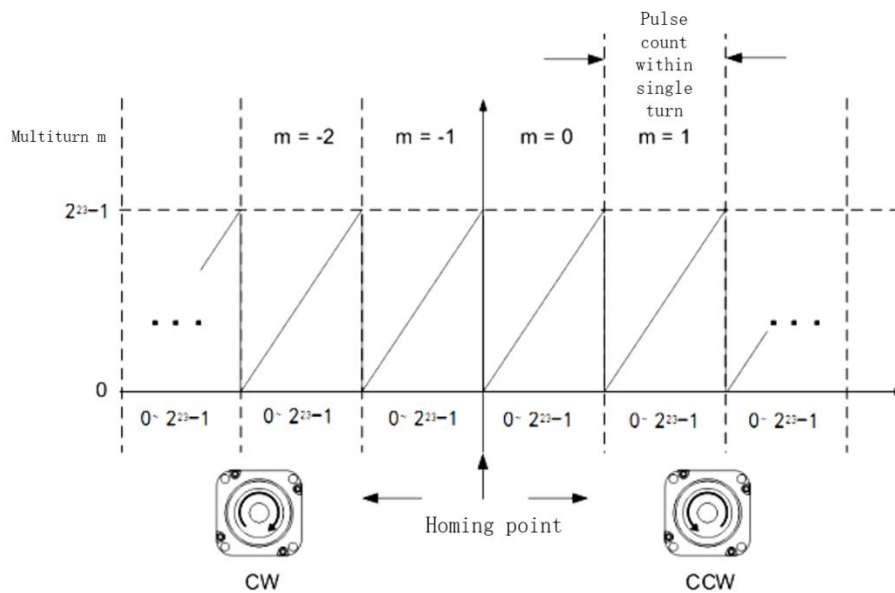

3、Clear multiturn position

Before clearing multiturn position, axis needs to be homed. After clearing multiturn position, revolution count = 0 but absolute position remains unchanged and Err153 alarm will be cleared.

Please make sure the homing point is within the range of 1 revolution of the rotor. Installation and setup of the homing point can be set with the use of auxiliary function D21 on the front panel. By setting Pr0.15 to 9, multiturn position will be cleared.

Please take notice of motor position during power on. Range of motion of a motor depends on the position of the motor during power on (23-bit absolute encoder as example).

5.11.3 Absolute Encoder Related Alarm

The alarm can determine if absolute value encoder is valid. If battery power is low, not a motor with absolute encoder, encoder error etc. occurs, user can find out about the error from alarm output or on the front panel. Controller will stop any operation until alarm is cleared.

Alarm output:

Err153 will be shown on front panel or by I/O ALM signal and from controller.

Err153 might occur,

(1) If absolute encoder is used for the first time and due to installation of new batteries Axis needs to be homed and multiturn data needs to be cleared.

(2) If battery voltage is lower than 3.2v. Replace battery and restart the motor.

(3) If battery voltage is lower than 2.5v or battery power was cut off. Replacing the battery won't clear the alarm. Axis needs to be homed and multiturn data needs to be cleared.

4、 Alarm processing flow chart

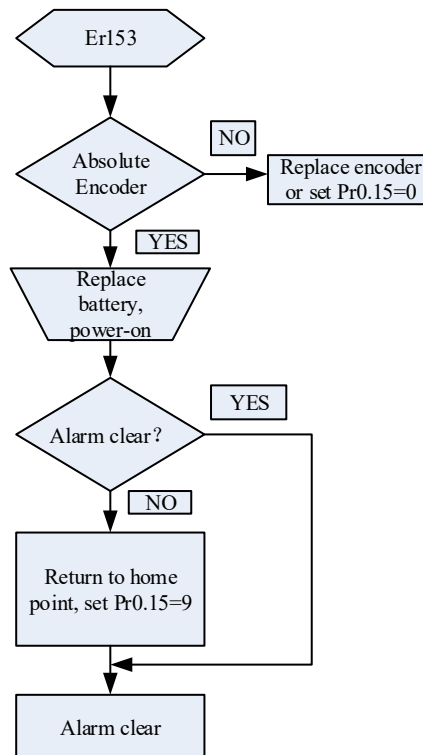

5.12 Regenerative resistor settings

When motor torque is acting the opposite direction of the rotational direction (i.e. Deceleration, vertical drop axis), energy will flow back into the drive. This will caused the capacitors inside the drive to increase in voltage which might cause over capacity. Regenerative resistor is required here to prevent over capacity of the capacitors.

Regenerative energy can be reduced by reducing rotational inertia, increasing deceleration time, decrease load torque or reduce max. rotational velocity.

Pr0.16	Label	Regenerative resistance			Valid mode(s)	P	S	T																								
	Range	25~500	Unit	Ohm	Default	100																										
	Byte length	16bit	Attribute	R/W	485 address	0x0021																										
	Valid	Immediate																														
To set resistance value of regenerative resistor Pr0.16 and Pr0.17set value determine alarm threshold of Er120. If set value > actual regenerative resistance, Er120 occurrence might be delayed.																																
Pr0.17	Label	Regenerative resistor power rating			Valid mode(s)	P	S	T																								
	Range	20~5000	Unit	W	Default	50																										
	Byte length	16bit	Attribute	R/W	485 address	0x0023																										
	Valid	Immediate																														
To set power rating of regenerative resistor. Please refer to table below <table border="1" data-bbox="423 940 1175 1224" style="margin-left: 40px;"> <thead> <tr> <th>Drives</th> <th>Resistance (Ω)</th> <th>Power rating(W)</th> </tr> </thead> <tbody> <tr> <td>ELD2-RS7005B</td> <td>10</td> <td>30</td> </tr> <tr> <td>ELD2-RS7010B</td> <td>10</td> <td>50</td> </tr> <tr> <td>ELD2-RS7015B</td> <td>10</td> <td>50</td> </tr> <tr> <td>ELD2-RS7020B</td> <td>10</td> <td>100</td> </tr> <tr> <td>ELD2-RS7030B</td> <td>10</td> <td>100/150</td> </tr> <tr> <td>ELD2-RS7040B</td> <td>10</td> <td>150/200</td> </tr> <tr> <td>ELD2-RS7060B</td> <td>10</td> <td>150/200</td> </tr> </tbody> </table>									Drives	Resistance (Ω)	Power rating(W)	ELD2-RS7005B	10	30	ELD2-RS7010B	10	50	ELD2-RS7015B	10	50	ELD2-RS7020B	10	100	ELD2-RS7030B	10	100/150	ELD2-RS7040B	10	150/200	ELD2-RS7060B	10	150/200
Drives	Resistance (Ω)	Power rating(W)																														
ELD2-RS7005B	10	30																														
ELD2-RS7010B	10	50																														
ELD2-RS7015B	10	50																														
ELD2-RS7020B	10	100																														
ELD2-RS7030B	10	100/150																														
ELD2-RS7040B	10	150/200																														
ELD2-RS7060B	10	150/200																														
Pr0.16 and Pr0.17 determines the threshold value of Er120. Please set accordingly or it might trigger false alarm or damage to servo drive. <i>Note: If external regenerative resistor is used, please set according to its labeled power rating.</i>																																

Chapter 6 Modbus communication

6.1 Communication connection

- RS232 tuning port – Connect to PC tuning software (CN7)
- RS485 communication – Connect to other drives or master device (CN5)

RS485 network of multiple servo drives

If there is a need to connect multiple ELD2-RS series servo drives together, it is recommended to connect the drivers in series and no longer than 3 meters of CABLE-TX*M*-LD2 cable between each nodes (drivers) as shown below.

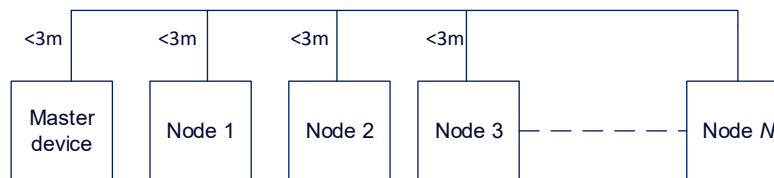

- *Keep the connection cable between each node as short as possible. Not longer than 3m.*
- *Install a terminal resistor each end. Recommended resistance: 120 Ohm.*
- *Please use shielded twisted pair connection cables.*
- *Connect to reference ground of the driver.*
- *Connect shielded foil of the cables to Protective Earth PE terminal.*
- *Please separate them from power cable or any cable with strong interference.*

6.2 Modbus RS485 communication parameters and ports

Communication parameters

Pr5.29	Label	RS485 communication mode			Valid mode(s)	P	S	T																												
	Range	0~255	Unit	—	Default	5																														
	Byte length	16bit	Attribute	R/W	485 address	0x053B																														
	Valid	After restart																																		
<table border="1"> <thead> <tr> <th>Value</th> <th>Bit</th> <th>Checksum</th> <th>Stop</th> </tr> </thead> <tbody> <tr> <td>0</td> <td>8</td> <td>Even</td> <td>2</td> </tr> <tr> <td>1</td> <td>8</td> <td>Odd</td> <td>2</td> </tr> <tr> <td>2</td> <td>8</td> <td>Even</td> <td>1</td> </tr> <tr> <td>3</td> <td>8</td> <td>Odd</td> <td>1</td> </tr> <tr> <td>4</td> <td>8</td> <td>Null</td> <td>1</td> </tr> <tr> <td>【5】</td> <td>8</td> <td>Null</td> <td>2</td> </tr> </tbody> </table>									Value	Bit	Checksum	Stop	0	8	Even	2	1	8	Odd	2	2	8	Even	1	3	8	Odd	1	4	8	Null	1	【5】	8	Null	2
Value	Bit	Checksum	Stop																																	
0	8	Even	2																																	
1	8	Odd	2																																	
2	8	Even	1																																	
3	8	Odd	1																																	
4	8	Null	1																																	
【5】	8	Null	2																																	
Pr5.30	Label	RS485 communication Baud rate			Valid mode(s)	P	S	T																												
	Range	0~15	Unit	—	Default	4																														
	Byte length	16bit	Attribute	R/W	485 address	0x053D																														
	Valid	After restart																																		
<table border="1"> <thead> <tr> <th>Value</th> <th>Baud rate</th> <th>Value</th> <th>Baud rate</th> </tr> </thead> <tbody> <tr> <td>0</td> <td>2400bps</td> <td>【4】</td> <td>38400bps</td> </tr> <tr> <td>1</td> <td>4800bps</td> <td>5</td> <td>57600bps</td> </tr> <tr> <td>2</td> <td>9600bps</td> <td>6</td> <td>115200bps</td> </tr> <tr> <td>3</td> <td>19200bps</td> <td></td> <td></td> </tr> </tbody> </table> <p>Baud rate tolerance: 2400~38400bps±0.5%, 57600~115200bps±2%</p>									Value	Baud rate	Value	Baud rate	0	2400bps	【4】	38400bps	1	4800bps	5	57600bps	2	9600bps	6	115200bps	3	19200bps										
Value	Baud rate	Value	Baud rate																																	
0	2400bps	【4】	38400bps																																	
1	4800bps	5	57600bps																																	
2	9600bps	6	115200bps																																	
3	19200bps																																			
Pr5.31	Label	RS485 axis address			Valid mode(s)	P	S	T																												
	Range	0~127	Unit	—	Default	1																														
	Byte length	16bit	Attribute	R/W	485 address	0x053F																														
	Valid	After restart																																		
<p>When controller is connected to multiple axis and controller needs to identify the axis, Pr5.31 can be used to set the axis ID/address. Please set to a max of 31 if the communication is between RS232 and RS485</p>																																				

Switch SW to modify Baud rate and terminal resistor. Please refer to the table below.

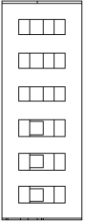
Diagram	Function		Pr6.33	SW4	Baud rate	SW1	SW2	Terminal resistor	SW3
	Motor direction	CCW (Default)	0	OFF	Pr5.30 Default: 9600	OFF	OFF	Disconnected	OFF
		CW		ON	19200	ON	OFF		
	Modbus high bit address	Spin dial	8	OFF	38400	OFF	ON	Connected	ON
		16+Spin dial		ON	57600	ON	ON		

ID spin dial

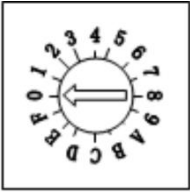
	Diagram	Bit	Modbus address	Bit	Modbus address
RCS-1 RCS-2		0	Pr5.31 Default : 16	8	8
		1	1	9	9
		2	2	A	10
		3	3	B	11
		4	4	C	12
		5	5	D	13
		6	6	E	14
		7	7	F	15

Communication Port

To be connected to other drives or master device (controller) – CN5

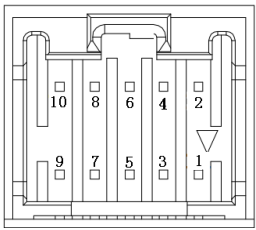
Port	Diagram	Pin	Signal	Label
CN5		1	RS485+	Modbus Data positive terminal
		3	RS485-	Modbus Data negative terminal
		5	GND	Power supply ground
		Others	NC	10 pins are not applicable

Note:

- Molex 55959-1030 Connector Header (Driver side)
- Molex 51353-1000 10-pin rectangle connector 1pcs for each axis (Provided)
- Molex 56134-9000 female terminal reel 10pcs for each axis (Provided)

6.3 Modbus Protocol

ELD2-RS series servo drives contain 16-bit including function code 0x03, 0x06 and 0x10.

- 0x03: Read data function code
- 0x06: Write single data function code
- 0x10: Write multiple data function code

6.3.1 Read Data 0x03

Read Data function code 0x03 can be used to read 1 – 100 16-bit data. For example, from servo drive to slave as 1 and reading 2 data. (H: High 8-bit, L: Low 8-bit)

No.	Request frame data (Master->Slave)			Reply frame data (Slave->Master)		
1	ID	Slave	0x01	ID	Slave	0x01
2	FC	Function code	0x03	FC	Function code	0x03
3	ADDR	Starting address	H	NUM	Data count (byte)	0x00(H)
4			L			0x04(L)
5	NUM	Data count (word)	0x00(H)	DATA1	Data 1	H
6			0x02(L)			L
7	CRC	Checksum	L	DATA2	Data 2	H
8			H			L
9				CRC	Checksum	L
10						H

Request frame and reply frame should have the same set of data as shown below.

Transmit	01 03 00 04 00 02 85 CA
Receive	01 03 04 00 00 00 02 7B F2

Send Frame: Request Frame. Master device writes a 2-Word (16 bit) data (0x0004) into slave servo drive with ID no. 1. Before frame transmission, 6 byte CRC checksum is 0xCA85

Receive Frame: Reply frame. Master device reads 4 byte (8bit) data from slave servo drive with ID no.1 successfully. Before receiving frame, 7 byte CRC checksum is 0xF27B.

6.3.2 Write single data 0x06

Function code 0x06 is to write single 16-bit data into servo drive. For example, from servo drive to slave station 1 and write 1 data. (H: High 8-bit, L: Low 8-bit).

No.	Request frame data (Master->Slave)			Reply frame data (Slave->Master)		
1	ID	Slave	0x01	ID	Slave	0x01
2	FC	Function code	0x06	FC	Function code	0x06
3	ADDR	Address	H	ADDR	Address	H
4			L			L
5	DATA	Data	H	DATA	Data	H
6			L			L
7	CRC	Checksum	L	CRC	Checksum	L
8			H			H

Communication data is as shown below (Transmit and receive data should be the same):

Transmit	01 06 00 04 00 02 49 CA
Receive	01 06 00 04 00 02 49 CA

Send Frame: Request Frame. Master device writes a 1 Word (16 bit) data (0x0002) into slave servo drive with ID no. 1 (Address 0x0004). 6-byte CRC value is 0xCA49 before frame sending.

Receive Frame: Reply frame. Master device writes data into slave servo drive with ID no. 1 and get same data frame back.

6.3.3 Write multiple data 0x10

Function code 0x10 is to write multiple 16-bit data into servo drive. For example, from servo drive to slave as 1 and reading 2 data. (H: High 8-bit, L: Low 8-bit).

Request frame data (Master->Slave)				Reply frame data (Slave->Master)		
1	ID	Slave	0x01	ID	Slave	0x01
2	FC	Function code	0x03	FC	Function code	0x03
3	ADDR	Starting address	H	ADDR	Address	H
4			L			L
5	NUM1	Data count (word)	0x00(H)	NUM	Data count (word)	H
6			0x02(L)			L
7	NUM2	Data count (Byte)	0x04 (2*NUM1)	CRC	Checksum	L
8	DATA1	Data 1	H			H
9			L			
10	DATA2	Data 2	H			
11			L			
12	CRC	Checksum	L			
13			H			

Servo parameters are 32-bit with high 16-bit at the front and low 16-bit at the back. 2 continuous communication addresses will be distributed starting with even number (High 16-bit uses even number address, low 16-bit uses odd number address. Word byte frame word is also with high 8-bit at the front and low 8-bit at the back.

32-bit data written from starting address 0x0000 (Servo driver with axis address 01):

Send	01 10 00 00 00 02 04 01 00 00 00 F3 A0
Receive	01 10 00 04 00 02 00 09

Send Frame: Request Frame. Master device writes a 2 Word (16 bit), 4 bytes data (0x0000 0000) into slave servo drive with ID no. 1 (Address 0x0000). 11-byte CRC value is 0xAFF3 before frame sending.

Receive Frame: Reply frame. Master device writes a 2 Word value into slave servo drive with ID no. 1 (Address 0x0000). 6-byte CRC value is 0xC841 before frame sending.

6.3.4 Reply error

When driver receives request frame data format with error, driver will feedback error reply data frame to master device.

No.	Error reply frame data (Slave->Master)		
1	ID	Slave ID	0~31
2	FC	Function code	(0x03/0x06/0x10)+0x80
3	Error code	Address	0x01/0x02/0x03
4	CRC	Checksum	L
5			H

Error code table:

Error code	Description
0x01	Function code error
0x02	Address error
0x03	Data error, i.e. written data over limit
0x08	CRC checksum error

Communication data:

Receive frame: Slave servo drive's reply frame. Request frame data CRC from master device, servo drive will not respond to current request.

```
[Send]01 11 00 04 00 02 04 01 00 00 00 F3 A0
[Receive]01 91 01 4C 56
```

Receive frame: Slave servo drive's reply frame. Request frame data function from master device error or slave station does not support this function, unable to respond to current request.

```
[Send]01 11 00 04 00 02 04 01 00 00 00 A2 65
[Receive]01 91 01 8C 50
```

6.3.5 Auxiliary function parameters

Auxiliary functions are activated by sending control word.

Done status can be monitored using status word. Status reset to initialization after reading status word.

Control Word:

Registry Address	Label	Operation
0x1801	Control word	Write

Control Word	Auxiliary Function
0x1111	Reset current alarm
0x1122	Reset history alarm
0x2211	Save all parameter to EEPROM
0x2222	Parameter initialization (not including motor parameters)

0x2233	Reset all parameters to factory default
0X4001	JOG left (once every 100ms)*
0X4002	JOG right (once every 100ms)*

Note: Continuous JOG motion is only possible if signal is triggered with interval time under 100ms. Step motion if interval time >100ms.

Parameter saving status word:

Registry Address	Label	Operation
0x1901	Status word	Read

Status word	Description
0x5555	Successfully saved
0xAAAA	Failed to save

6.3.6 Alarm info parameters

Registry Address	Label	Operation
0x2203	Current Alarm	Read

Servo Alarm: Addr. 0x2203			
Effective bit[11:0]value(Hex) High 4-bit[15:12] <i>masked</i>	Alarm	Effective bit[11:0]value(Hex) High 4-bit[15:12] <i>masked</i>	Alarm
0x000	Normal	0x190	Excessive motor vibration
0x0E1/ 0x0E0	Overcurrent	0x150	Encoder disconnected
0x100	Overload	0x151/0x170	Encoder data error
0x180	Excessive position deviation	0x152	Encoder HALL signal error
0x1A0	Overspeed	0x240	Parameter saving error
0x1A1	Motor out of control	0x570	Emergency stop
0x0D0	Undervoltage	0x120	Regenerative energy overload
0x0C0	Overvoltage	0x153	Encoder battery error
0x171/0x172	Encoder parameter error	0x210/0x211/0x212	Input configuration error (Repeated/wrong input)
Others	Please refer to Chap. 9		

6.4 Frequently occurred issues and solutions with RS485 communication.

Terminal resistor

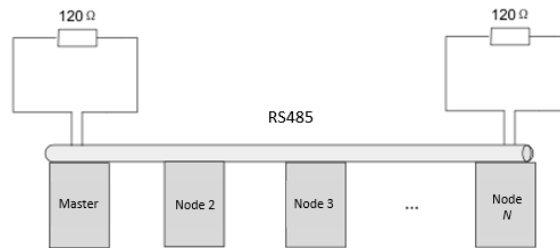

Terminal resistor is to be connected at the start and end of the device network. Recommended resistance of the terminal resistor: 120 Ohm. Measure the resistance within the network using a multimeter and refer to the table below.

Measured resistance (Ohm)	Normal: 60 Ohm	Description
0		Short circuit
Much lower than 60		Might be other resistor within the network; incorrect terminal resistor is used
Much higher than 60		Might be due to damaged/faulty node communication port

Incorrect wiring connection

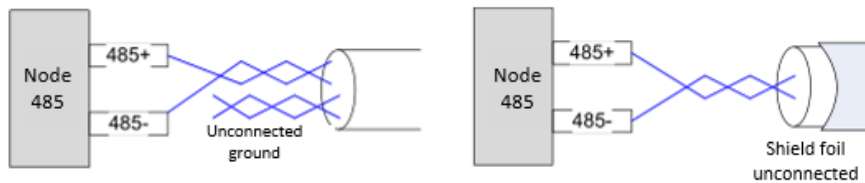

Please make sure RS485 communication connection is normal using a multimeter. Then, make sure the reference ground is corrected connected. If there is not no reference ground, please leave it unconnected. Same goes for cable shield foil.

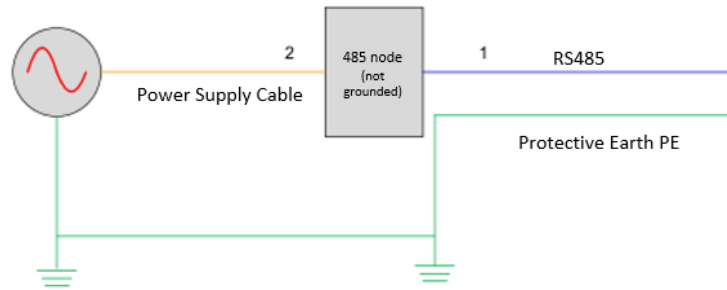
Signal interference

External interference: Magnetic ring can be intertwined within cable 1 and 2 to prevent external interference.

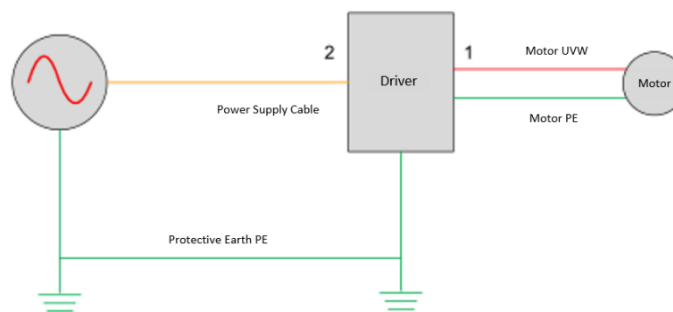

Driver interference: If interference occurs within the driver, please intertwine magnetic rings on cable 1 and 2. Please loop UVW cables around the magnetic ring for at least 3 rounds. Do not loop PE wire into the magnetic ring.

Step-by-step problem solving

- 1: Verify if communication parameters setting are correct (ID not repeated, uniform Baud rate and data format);
- 2: If terminal resistor used is correct;
- 3: If wiring connection is correct;
- 4: Verify grounding and PE connection;
- 5: Communication cables should be separated from power cables.

Servo drives are devices of good anti-interference. However, during installation, interference still might occur due to wiring and grounding issues. Please refer to the table below if such problems persist.

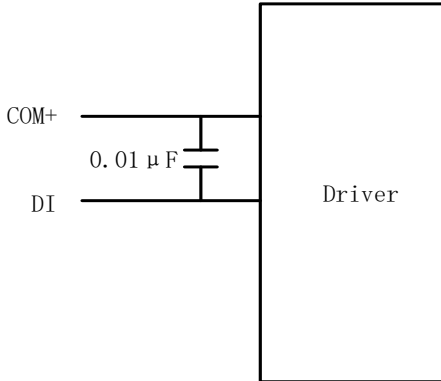
Steps	Solutions
1	Use shielded wire cable for I/O signals, connect shield foil to PE.
2	Connect motor PE to PE terminals on drivers, connect driver PE to PE terminals of electrical network.
3	Ground master device and servo drives together.
4	Loop UVW motor power cable around magnetic ring for 2-3 times.
5	Loop signal cable around magnetic ring for 1-2 times.
6	Use shielded cable for power cables. Connect shield foil to ground.
7	<p>Connect a capacitance filter onto DI input. Max capacitance: 0.1 μF</p>  <p>The diagram shows a rectangular box labeled 'Driver'. To its left, there are two horizontal lines representing signal lines. The top line is labeled 'COM+' and the bottom line is labeled 'DI'. A capacitor, represented by two parallel vertical lines, is connected between these two lines. The capacitor is labeled '0.01 μF'.</p>

Chapter 7 PR mode

PR function is a control module in servo drive that controls single axis motion using PProcedure program. Main single axis motion control functions included homing, path, position limit and emergency stop. Using PR functions can save the resources on the main controller.

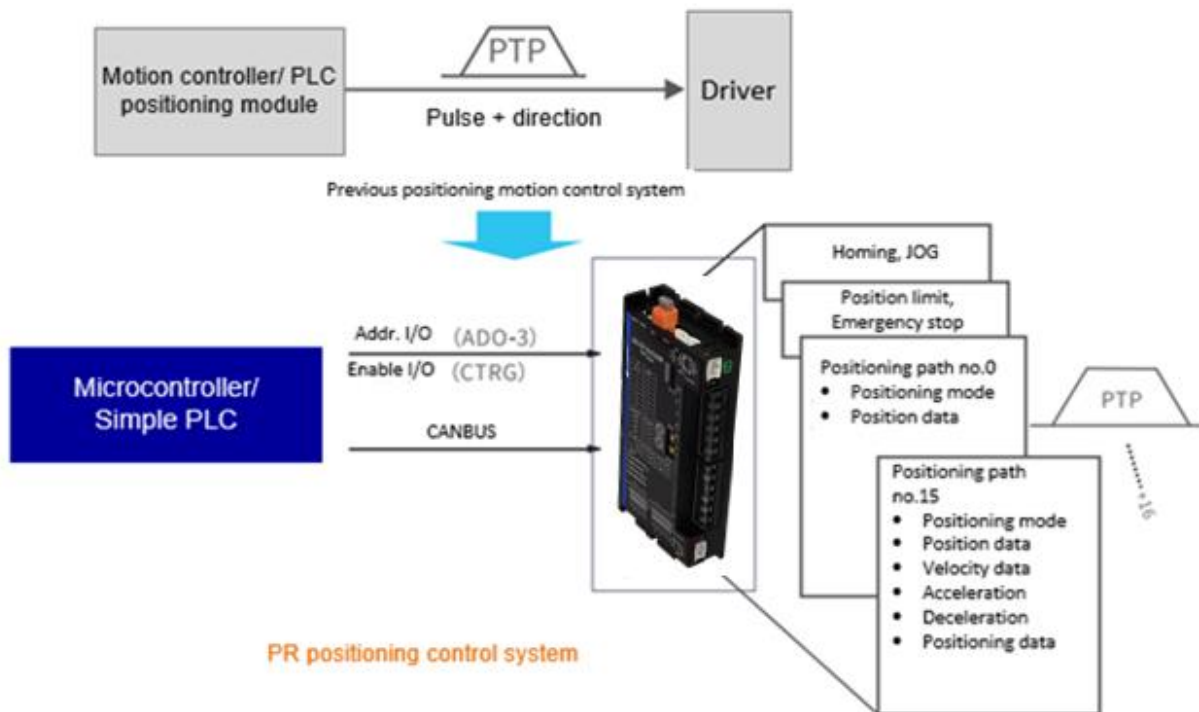

Please set Pr0.01 = 6 when using PR functions. All position unit: 10000 Pulse/r

7.1 PR functions introduction

Function	Description
Homing	Driver seeks origin signal through homing to determine zero point of the mechanical motion coordination system <ol style="list-style-type: none"> 1. Homing mode configurable. Can be chosen between position limit signal homing, origin signal homing and manually set home; 2. Homing direction configurable; 3. Specific position can be set after homing completed; 4. Homing velocity, acceleration and deceleration configurable. 5. High homing velocity to locate origin and low homing velocity to look for Z-signal
JOG	Forward/Reverse JOG through I/O control. Used for tuning. <ol style="list-style-type: none"> 1. JOG direction: forward JOG, reverse JOG 2. JOG velocity and acceleration configurable
Position limit	Prevent mechanical damage by limiting the range of motion <ol style="list-style-type: none"> 1. Positive/Negative position limit input through I/O 2. Software position limit 3. Position limit deceleration configurable
Emergency stop	Emergency stop input signal through I/O. To stop any operating motion
Path motion	Select path ID through IO (ADD0-3) , then trigger path motion through enable IO (CTRG) ; or directly through I/O combination mode ; path motion can be controlled directly through 485 communication as well <ol style="list-style-type: none"> 1. Path motion includes positioning, velocity and homing modes. 2. I/O trigger includes rising edge, double edges trigger 3. Supports continuous positioning ; 4. Max. 16 paths ; 5. Configurable position, velocity and acceleration/deceleration ; 6. Pause time/ timer configurable
485 communication	PR parameter R/W through 485 communication. Control PR functions such as homing, JOG, path motion, emergency stop, etc.

7.2 Control parameters

All PR motion related parameters including trigger, status output, limits, emergency stop, JOG, homing, etc.

Parameter	Label	Description	485 Addr.
Pr8.00	PR Control	PR control functions Bit 0: =0, CTRG rising edge trigger =1, double edges trigger ; Bit 1: =1, software position limit valid, =0, software position limit not valid; Bit 2: =1, homing upon power on , =0, no homing upon power on Bit 3: =1, absolute value memory, =0, absolute value with no memory,	0X6000
Pr8.01	Path count	16 paths	0X6001
Pr8.02	Control Operation	--	0X6002
Pr8.06	Software positive limit H	High 16-bit of software positive limit	0X6006
Pr8.07	Software positive limit L	Software positive limit (Only able to read low 16-bit using 485 communication)	0X6007
Pr8.08	Software negative limit H	High 16-bit of software negative limit	0X6008
Pr8.09	Software negative limit L	Software negative limit (Only able to read low 16-bit using 485 communication)	0X6009
Pr8.10	Homing mode	Homing method in PR mode Bit 0: Homing direction =0 : Reverse; =1: Forward Bit 1: Specific position after homing =0: No; =1: Yes Bit2~7: Homing mode =0: Position limit homing =1: Origin homing =2: Single turn Z homing =3: Torque homing =8: Immediate homing Bit 8: =1: Homing with Z-signal = 0: Homing without Z-signal <i>Single turn Z homing is homing method within 1 revolution, has nothing to do with Bit 8 Z-signal.</i>	0X600A
Pr8.11	Zero position H	High 16-bit of zero position	0X600B
Pr8.12	Zero position L	Zero position (Only able to read low 16-bit using 485 communication)	0X600C
Pr8.13	Home position offset H	High 16-bit of home position offset	0X600D
Pr8.14	Home position offset L	Home position offset (Only able to read low 16-bit using 485 communication)	0X600E

Pr8.15	High homing velocity	Set high homing velocity	0X600F
Pr8.16	Low homing velocity	Set low homing velocity	0X6010
Pr8.17	Homing acceleration	Set homing acceleration	0X6011
Pr8.18	Homing deceleration	Set homing deceleration	0X6012
Pr8.19	Homing torque holding time	Set homing torque holding time	0X6013
Pr8.20	Homing torque	Set homing torque value	0X6014
Pr8.21	Homing overtravel alarm range	Set homing overtravel alarm threshold, set to 0 to deactivate the alarm	0X6015
Pr8.22	Emergency stop at limit deceleration	Set position limit emergency stop deceleration	0X6016
Pr8.23	STP emergency stop deceleration	Set STP emergency stop deceleration	0X6017
Pr8.26	I/O combination trigger mode	0: Disable I/O combination trigger mode. Uses I/O CTRG signal edge trigger. 1: Enable I/O combination trigger. Valid when HOME-OK signal is valid. 2: Enable I/O combination trigger. HOME-OK signal not required.	0X601A
Pr8.27	I/O combination filter	Set I/O combination filter time	0X601B
Pr8.28	S-code current output value	Display S-code output	0X601C
Pr8.29	PR warning	=0: Reset new command automatically; =0x100; Position limit error during homing =0x101; Emergency stop. Homing not completed; =0x20x; Position limit error on Path N	0X601D
Pr8.39	JOG velocity	Set JOG velocity	0X6027
Pr8.40	JOG acceleration	Set JOG acceleration	0X6028
Pr8.41	JOG deceleration	Set JOG deceleration	0X6029
Pr8.42	Command position H	High 16- bit of command position	0X602A
Pr8.43	Command position L	Command position (Only able to read low 16-bit using 485 communication)	0X602B
Pr8.44	Motor position H	High 16- bit of motor position	0X602C
Pr8.45	Motor position L	Motor position (Only able to read low 16-bit using 485 communication)	0X602D
Pr8.46	Input	Input status	0X602E
Pr8.47	Output	Output status	0X602F
Pr8.48 - Pr8.63	S-code setting	Path N S-code output settings	0x6030 ~ 0x603F

7.3 PR Motion

7.3.1 Homing

Homing is divided into 5 methods according to home signal: Single turn Z-phase homing, position limit homing, origin homing, torque homing, manually set home. Position limit homing, origin homing and torque homing can be with or without Z-signal. Homing can be triggered upon power on or using I/O after servo enabled.

Homing sequence diagram

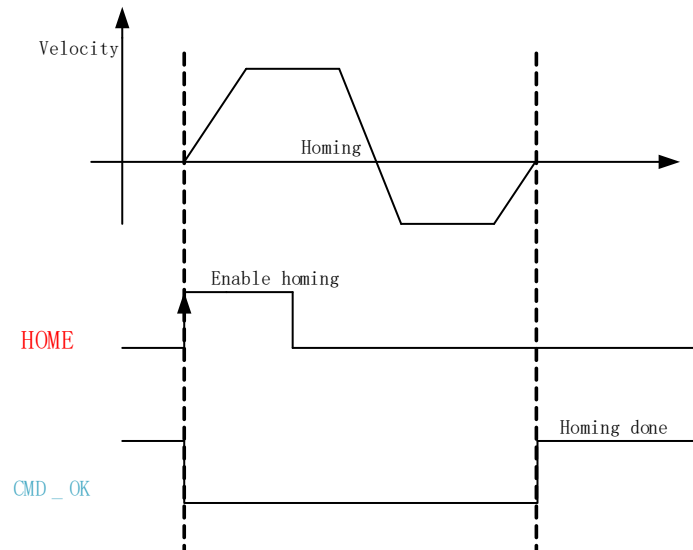

1. **HOME**: Homing trigger signal. When HOME is valid, homing will be done according to set homing method.
2. **CMD_OK**: Command completed signal. Invalid when command is being carried out, valid when command is done.
3. Please refer to Pr8.10 to set homing methods and other homing mode related settings. It is recommended to use Motion Studio to modify the control parameters in PR mode.

Pr8.10	Label	Homing mode			Valid mode(s)	PR
	Range	0~ 0xFFFF	Unit	/	Default	0
	Byte length	16bit	Attribute	R/W	485 address	0X600A
To set homing method in PR mode. It is recommended to modify PR control parameters using Motion Studio.						
	Bit	8 (Z-signal homing)	2-7 (Homing mode)	1 (Specific position after homing)	0 (Homing direction)	
	Description	=1, homing with Z-signal =0, homing without Z-signal	=0 Limit homing =1 Origin homing =2 Single turn Z homing =3 Torque homing =8 Immediate homing	=1, Yes =0, No	=1, Forward =0, Reverse	

Position limit, origin and torque homing with Z-signal

1. Negative limit homing

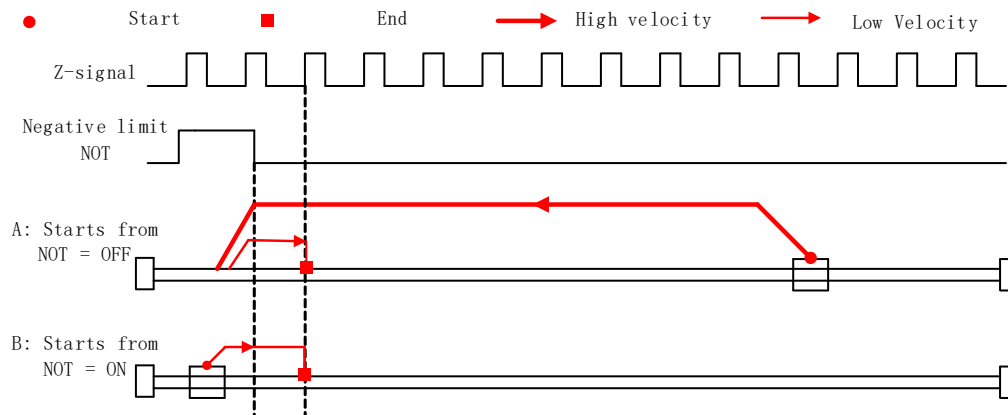

2. Positive limit homing

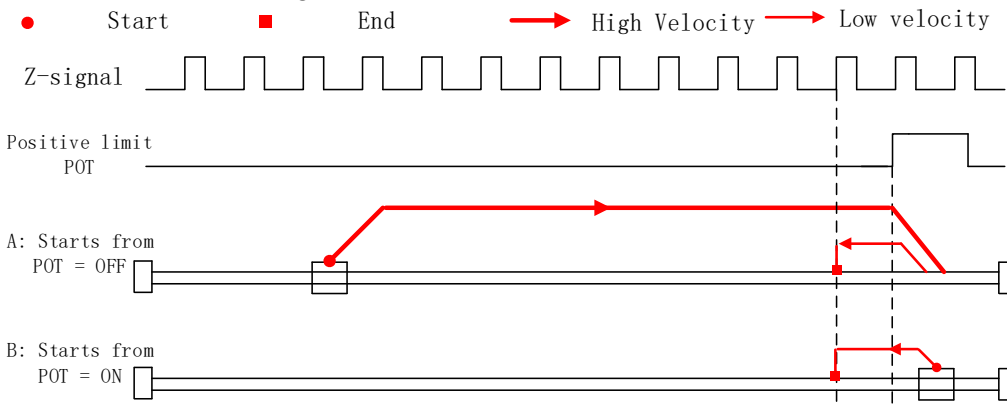

3. Origin homing – Negative direction

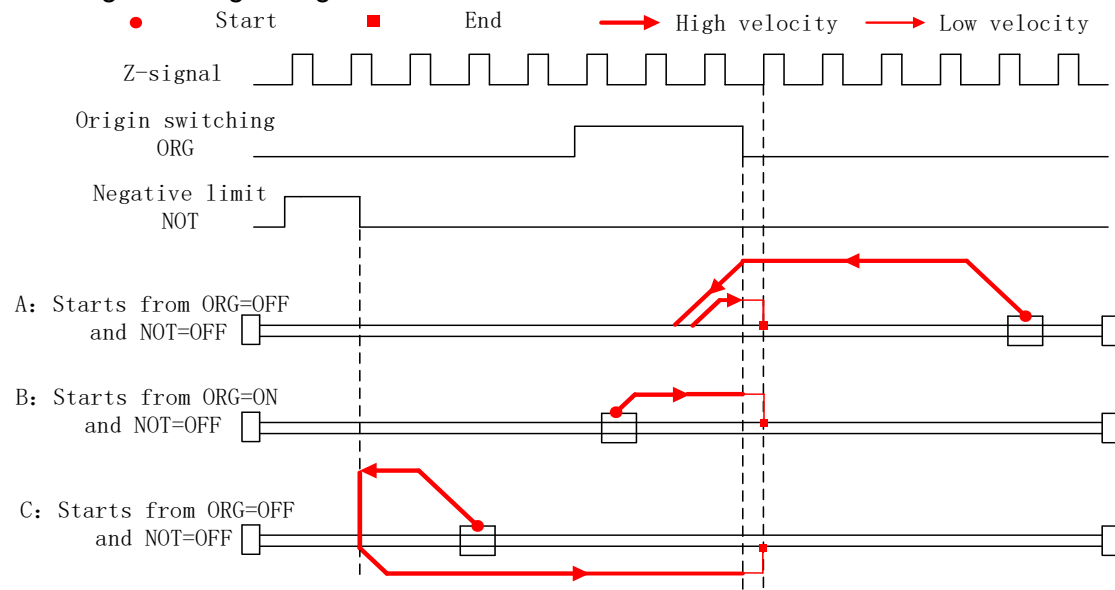

4. Origin homing – Positive direction

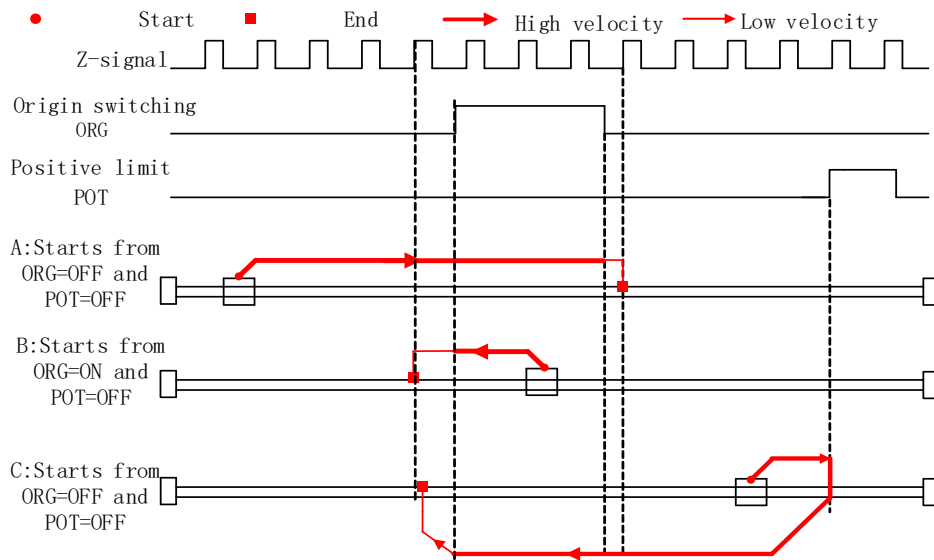

5. Torque homing – Negative direction

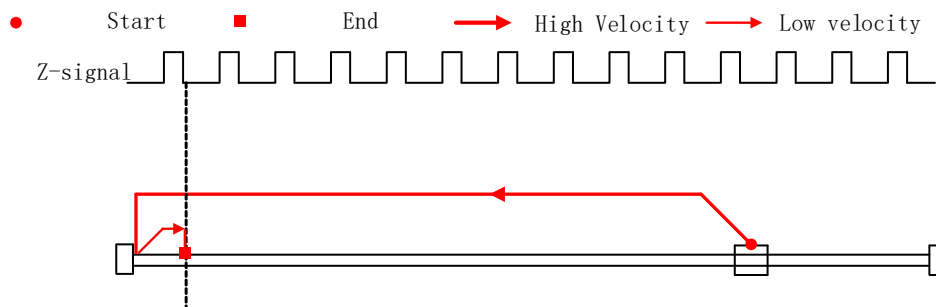

6. Torque homing – Positive direction

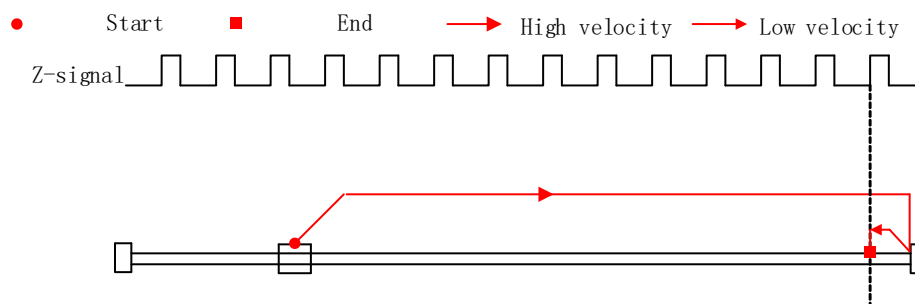

Position limit, origin, torque and manual set home (Homing with single condition)
1. Negative limit homing

● Start ■ End → High velocity → Low velocity

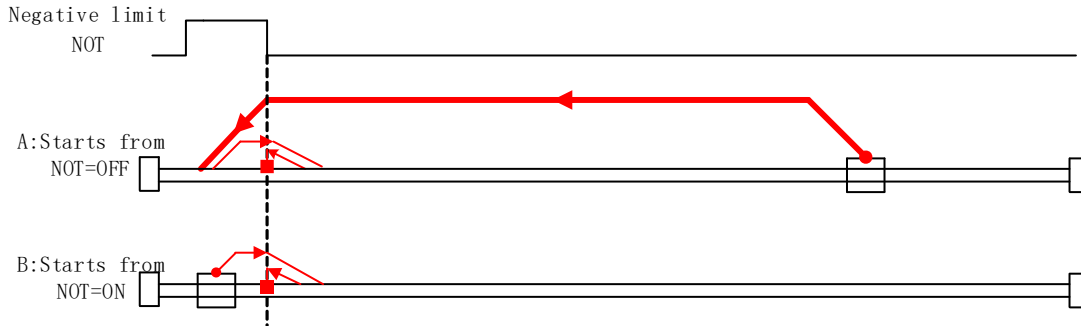
2. Positive limit homing

● Start ■ End → High velocity → Low velocity

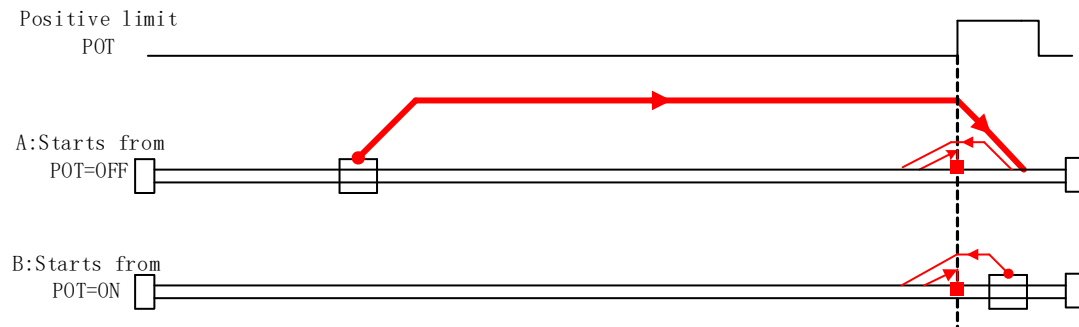
3. Origin homing – Negative direction

● Start ■ End → High velocity → Low velocity

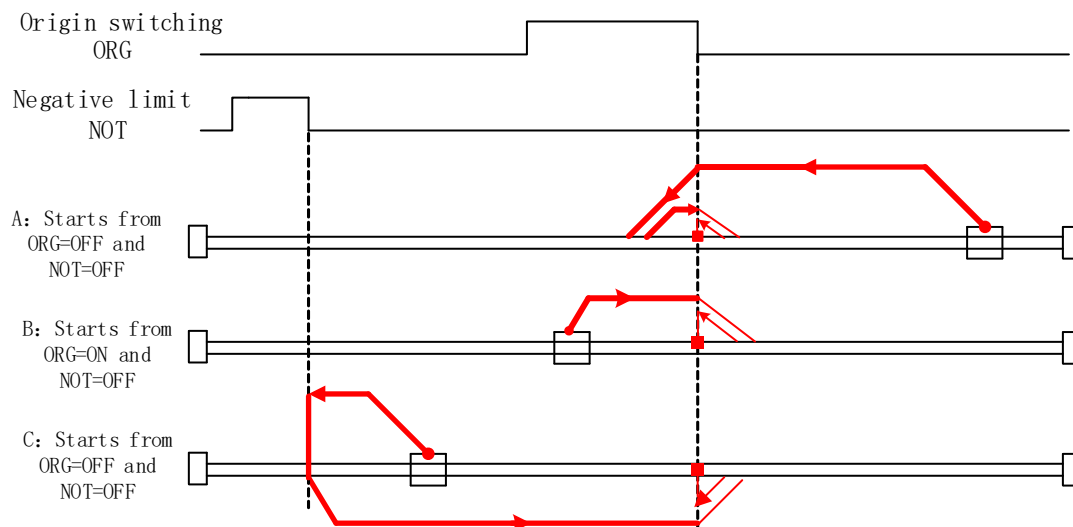

4. Origin homing – Positive direction

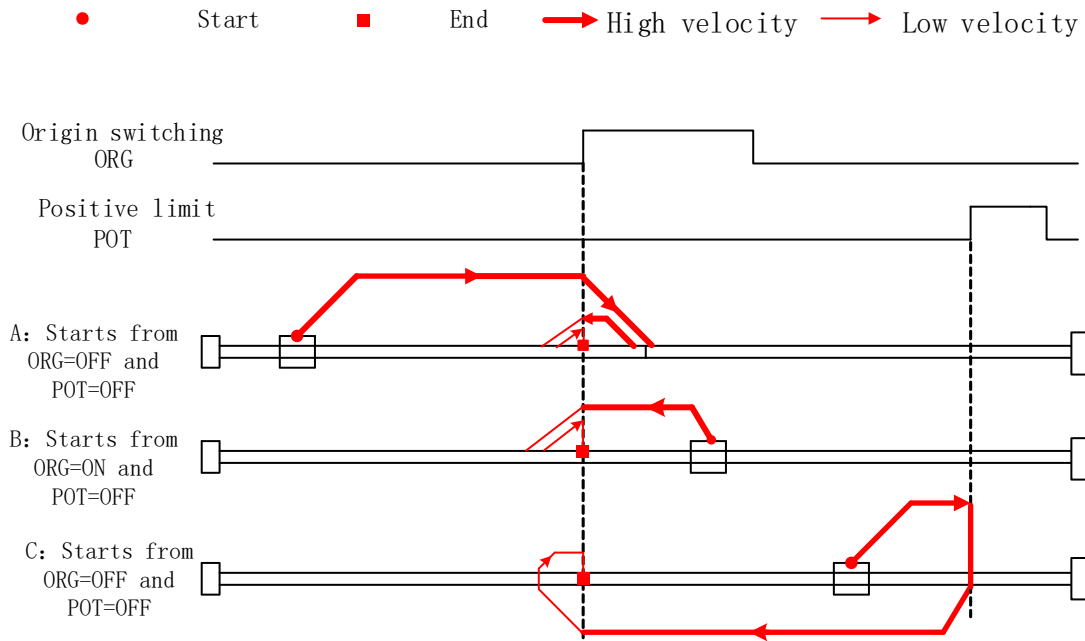

5. Torque homing – Negative direction

● Start ■ End → Low velocity

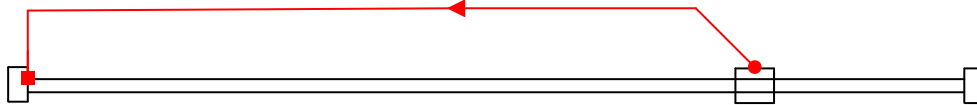

6. Torque homing – Positive direction

● Start ■ End → Low velocity

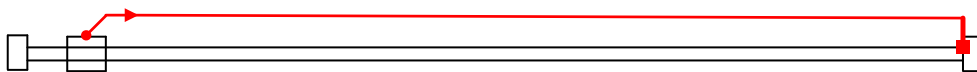

7.3.2 Position limit and emergency stop

For safety concerns, PR mode is designed to trigger emergency stop when position limit or emergency stop signal is valid. Please refer to the sequence diagram below.

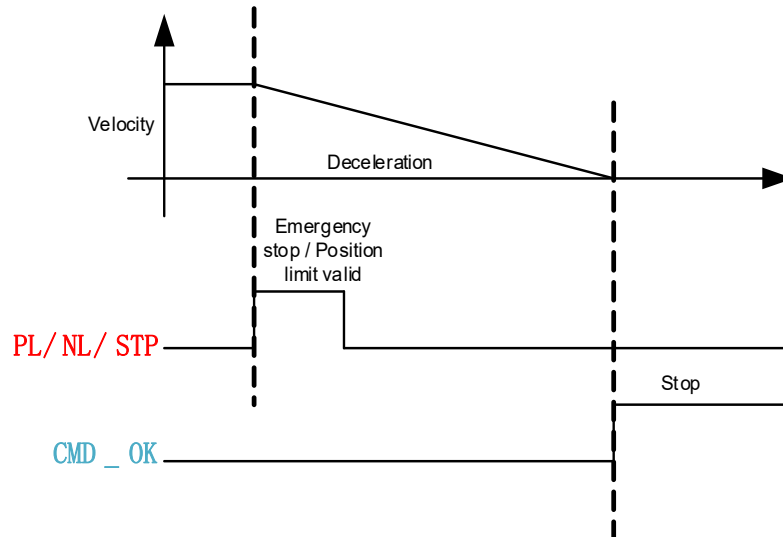

7.3.3 JOG

JOG is used to make tuning more convenient. Please refer to the sequence diagram below for motion profile during JOG

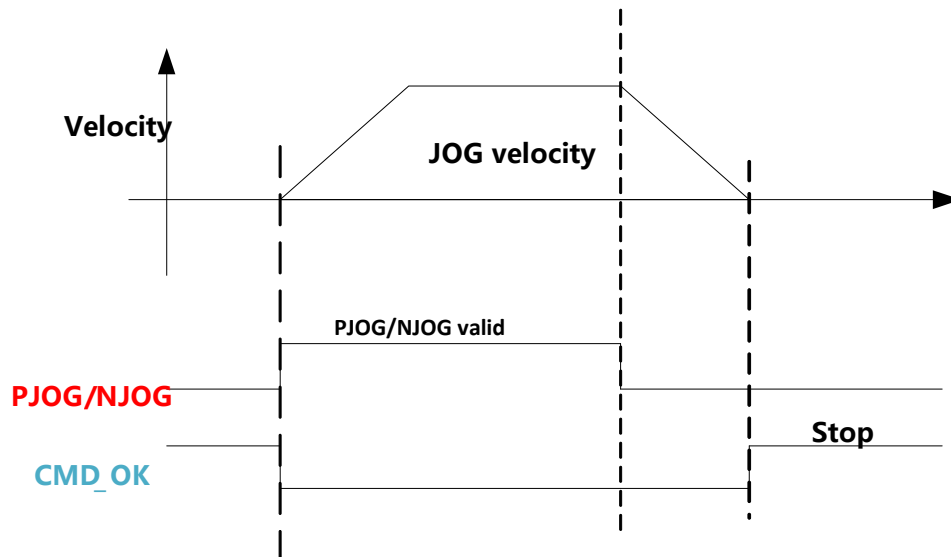

7.3.4 Path motion

Path motion: Segmented, continuous, interrupted. Path positioning: Position, velocity, homing.

PR path is to a total of 16 paths. Every path can be set with motion type, positioning mode, velocity, acceleration, deceleration and pause time independently.

Parameter	Label	Description	485 addr.
Pr9.00	PR mode	Attribute of PR path is determined by its mode. Bit 0-3: type : 0: null 1: Positioning 2: Velocity 3: Homing 4: Emergency stop <i>Indicates using P/V/H/S</i> Bit 4: 0: Can be Interrupted 1: Can't be Interrupted, indicates using ! Bit 5: OVL P: 0: No overlap, indicates with SJ 1: Overlap, indicated with CJ Bit 6-7: 0: absolute 1: relative command 2: relative motor <i>Corresponding to ABS/INC/REL</i> Bit 8-13: 0-15: Jump to corresponding path <i>Indicates using SJ0x or CJ0x</i> Bit 14: JUMP: 0: No Jump, indicates with END 1: Jump. Jump to SJ or CJ	0X6200
Pr9.01	PR position H	High 16-bit of PR path position	0X6201
Pr9.02	PR position L	PR position (Only able to read low 16-bit using 485 communication)	0X6202
Pr9.03	Velocity	Velocity, rpm	0X6203
Pr9.04	Acceleration time	Unit ms/1000rpm	0X6204
Pr9.05	Deceleration time	Unit ms/1000rpm	0X6205
Pr9.06	Pause time	Pause time after command completed	0X6206
Pr9.07	Special parameter	Mapped to Pr8.02	0X6207
Pr9.08 ~ Pr9.127		8 parameters for each path. Please refer to Class 9 parameter in Chapter 3	

Path motion
Segmented trigger

CTRG rising edge/double edges trigger (Pr8.00) a segmented motion. Please refer to the sequence diagram below with rising edge trigger of path 5.

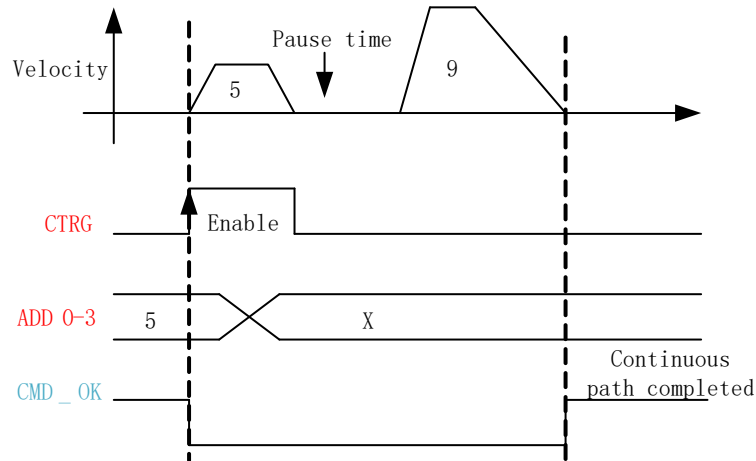

Multi-path interrupted motion

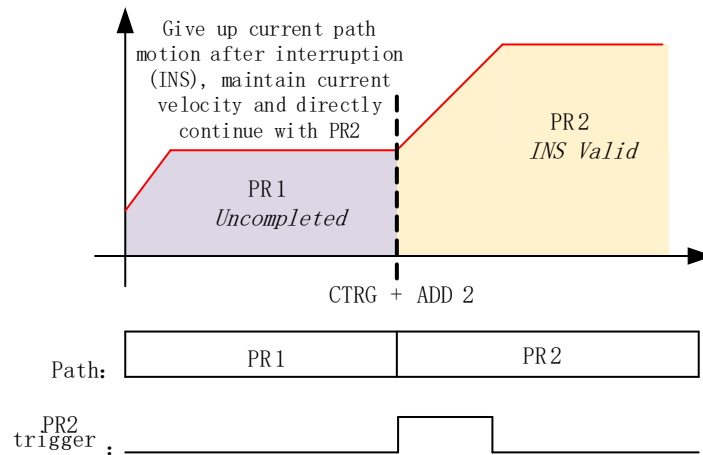
In multi-path motion, path motion that is triggered later will interrupt path motion that has already started. Please refer to the sequence diagram below

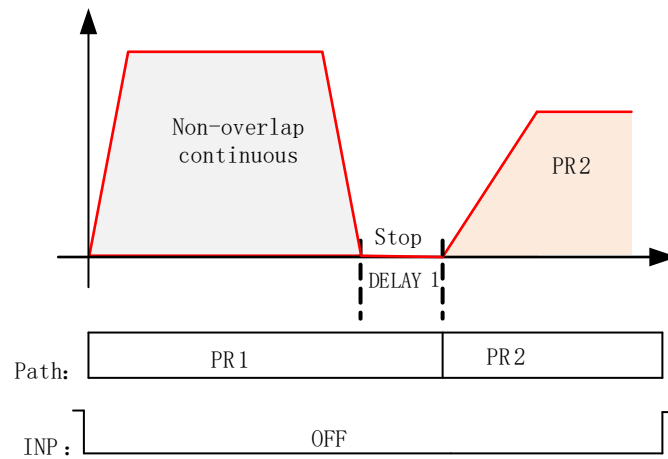

Non-overlap continuous motion

Path motion continues by another, no trigger needed for the next one to start.



Overlapping continuous motion

Path motion starts immediate after the previous path motion is completed without deceleration or trigger in between.

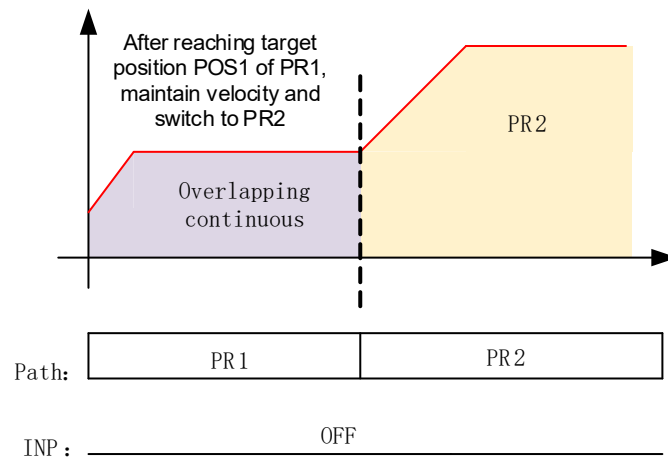

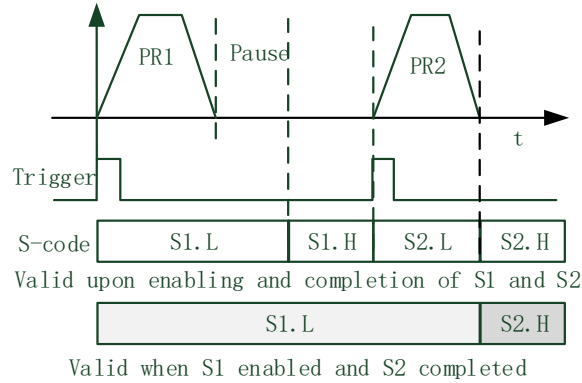

S-code bit	bit0/8	bit1/9	bit2/10	bit3/11	bit4/12	bit5/13	Bit6/14
SDx	SD0	SD1	SD2	SD3	SD4	SD5	SD6

I/O trigger

Path motion trigger: Edge trigger/combination trigger(Pr8.26). Edge trigger is triggering path combination motion using I/O. I/O combination trigger uses electrical level as trigger rather than signal edge. No valid motion for path 0 and I/O combination triggers motion once after I/O filter when converted to non-zero paths.

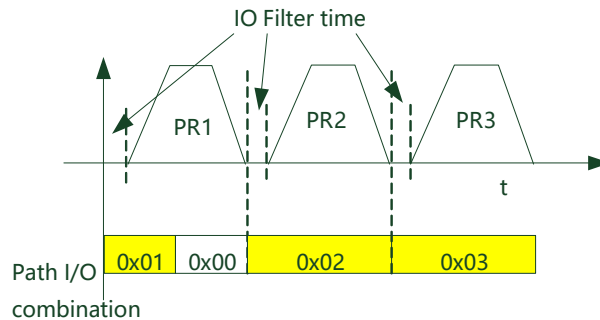

****Path combination 0 is invalid because I/O combination $x>0 \rightarrow x$ can be triggered for multiple times when using incremental position.**

***In I/O combination trigger mode 2, path motion will be triggered upon servo drive power on if I/O combination not set to 0. Please be careful.**

Pr8.26	Label	I/O combination trigger mode		Valid mode(s)	PR	
	Range	0 ~ 65535	Unit	/	Default	0
	Byte length	16bit	Attribute	R/W	485 address	0X601A
	Value	Description				
	【0】	Disable I/O combination trigger mode. Uses I/O CTRG signal edge trigger.				
	1	Enable I/O combination trigger. Valid when HOME-OK signal is valid.				
	2	Enable I/O combination trigger. HOME-OK signal not required.				
IO combination trigger select path using ADD0~ADD3. Trigger mode is set in Pr8.26.						

ADD3	ADD2	ADD1	ADD0	Path selection
OFF	OFF	OFF	OFF	Path 0 (Non-action)
OFF	OFF	OFF	ON	Path1
OFF	OFF	ON	OFF	Path2
OFF	OFF	ON	ON	Path3
OFF	ON	OFF	OFF	Path4
OFF	ON	OFF	ON	Path5
OFF	ON	ON	OFF	Path6
OFF	ON	ON	ON	Path7
ON	OFF	OFF	OFF	Path8
ON	OFF	OFF	ON	Path9
ON	OFF	ON	OFF	Path10
ON	OFF	ON	ON	Path11
ON	ON	OFF	OFF	Path12
ON	ON	OFF	ON	Path13
ON	ON	ON	OFF	Path14
ON	ON	ON	ON	Path15

7.4.3 485 communication

485 communication can be used to achieve the same functions as with I/O, modifying PR related parameters and trigger path motions. Through this communication protocol, controlling of multiple axes can be realized, saving wiring works with flexibility in the system. 485 communication includes 2 kinds of mode: Fixed trigger and immediate trigger.

485 communication parameters

Parameter	Label	Description																												
Pr5.29	Communication mode	485 communication mode data																												
		<table border="1"> <thead> <tr> <th>Value</th> <th>Bit</th> <th>Checksum</th> <th>Stop</th> </tr> </thead> <tbody> <tr> <td>0</td> <td>8</td> <td>Even</td> <td>2</td> </tr> <tr> <td>1</td> <td>8</td> <td>Odd</td> <td>2</td> </tr> <tr> <td>2</td> <td>8</td> <td>Even</td> <td>1</td> </tr> <tr> <td>3</td> <td>8</td> <td>Odd</td> <td>1</td> </tr> <tr> <td>4</td> <td>8</td> <td>Null</td> <td>1</td> </tr> <tr> <td>【5】</td> <td>8</td> <td>Null</td> <td>2</td> </tr> </tbody> </table>	Value	Bit	Checksum	Stop	0	8	Even	2	1	8	Odd	2	2	8	Even	1	3	8	Odd	1	4	8	Null	1	【5】	8	Null	2
		Value	Bit	Checksum	Stop																									
		0	8	Even	2																									
		1	8	Odd	2																									
		2	8	Even	1																									
		3	8	Odd	1																									
4	8	Null	1																											
【5】	8	Null	2																											
Pr5.30	Baud rate	To set communication speed of RS485 communication																												
		<table border="1"> <thead> <tr> <th>Value</th> <th>Baud rate</th> <th>Value</th> <th>Baud rate</th> </tr> </thead> <tbody> <tr> <td>0</td> <td>2400bps</td> <td>【4】</td> <td>38400bps</td> </tr> <tr> <td>1</td> <td>4800bps</td> <td>5</td> <td>57600bps</td> </tr> <tr> <td>2</td> <td>9600bps</td> <td>6</td> <td>115200bps</td> </tr> <tr> <td>3</td> <td>19200bps</td> <td></td> <td></td> </tr> </tbody> </table>	Value	Baud rate	Value	Baud rate	0	2400bps	【4】	38400bps	1	4800bps	5	57600bps	2	9600bps	6	115200bps	3	19200bps										
		Value	Baud rate	Value	Baud rate																									
		0	2400bps	【4】	38400bps																									
		1	4800bps	5	57600bps																									
2	9600bps	6	115200bps																											
3	19200bps																													
Pr5.31	ID	Modbus slave ID address																												
Pr8.02	PR trigger	<table border="1"> <thead> <tr> <th>Attribute</th> <th>Index</th> <th>Description</th> </tr> </thead> <tbody> <tr> <td>Write</td> <td>0x01P</td> <td>N path positioning</td> </tr> <tr> <td>Write</td> <td>0x020</td> <td>Reset</td> </tr> <tr> <td>Write</td> <td>0x021</td> <td>Manually set currently position as 0 (Origin)</td> </tr> </tbody> </table>	Attribute	Index	Description	Write	0x01P	N path positioning	Write	0x020	Reset	Write	0x021	Manually set currently position as 0 (Origin)																
		Attribute	Index	Description																										
		Write	0x01P	N path positioning																										
		Write	0x020	Reset																										
Write	0x021	Manually set currently position as 0 (Origin)																												

		Write	0x040	Emergency stop
		Read	0x000P	Positioning completed. Ready to receive new data
		Read	0x01P, 0x020, 0x040	Yet to respond to command
		Read	0x10P	Path motion undergoing
		Read	0x200	Command completed. Waiting for positioning

PR mode communication address:

Class 8 parameters: $0x6000 + (\text{Param-ID} - 800)$. For example Pr8.06: $0x6000 + (806 - 800) = 0x6006$

Class 9 parameters: $0x6200 + (\text{Param-ID} - 900)$. For example Pr9.06: $0x6200 + (906 - 900) = 0x6206$

7.4.4 Path trigger

Fixed trigger

Fixed triggering method is to set all 16 paths homing and other settings, then through Pr8.02 (trigger register to replace CTRG and HOME) to enable path. Recommended for simple applications with fixed motions.

Steps:

1. Set homing and path attributes using Motion Studio. Power on driver for parameters to be valid.
2. Write corresponding command into 0x6002(Pr8.02) to realize required motions.

Attribute	Index	Description
Write	0x01P	N path positioning
Write	0x020	Reset
Write	0x021	Manually set currently position as 0 (Origin)
Write	0x040	Emergency stop
Read	0x000P	Positioning completed. Ready to receive new data
Read	0x01P, 0x020, 0x040	Yet to respond to command
Read	0x10P	Path motion undergoing
Read	0x200	Command completed. Waiting for positioning

Immediate trigger

Immediate trigger is more flexible while fixed triggering is restricted by 16 paths position. Path motion is triggered immediately once path is written. Motions such as position, velocity or homing are realized through data frame.

This triggering method uses PR0 with 8 datum from which Pr9.07 mapped into Pr8.02. When 0x10 is written into Pr8.02, it will trigger PR0 motion immediately.

Steps:

1. Set homing and path attributes using Motion Studio. (Homing parameters must be set) Power on driver for parameters to be valid.
2. Control specific path using Pr8.02.
3. Realize path motion by writing into Pr9.00 – Pr9.07 with Pr9.07 = 0x10

Master device request frame byte data

No.	Data	Description	Value
1	ID	Slave ID	1~127
2	FC	Function code	0x10
3	ADDR	Address	0x62
4	ADDR	Address	0x00
5~6	NUM1	Data count (Word)	0x0008
7	NUM2	Data count (Byte)	0x10
8-9	Pr9.00	Mode	XXXX

10-11	Pr9.01	Position high bit	XXXX
12-13	Pr9.02	Position low bit	XXXX
14-15	Pr9.03	Velocity	XXXX
16-17	Pr9.04	Acceleration	XXXX
18-19	Pr9.05	Deceleration	XXXX
20-21	Pr9.06	Delay time	XXXX
22-23	Pr9.07	Trigger control	0x0010
24	CRC	Checksum Lo	
25		Checksum Hi	

Slave response frame byte data

No.	Data	Description	Value
1	ID	Slave ID	1~127
2	FC	Function code	0x10
3	ADDR	Address	0x62
4	ADDR	Address	0x00
5	NUM	Data count (Word)	0x08
6	CRC	Checksum Lo	0XXX
7		Checksum Hi	0XXX

7.5 PR motion

7.5.1 Trigger using physical I/O

1. Set up servo drive parameter such as Pr0.01 = 6. Required PR I/Os are set in Pr4.00-Pr4.15
2. Set up PR control parameters such as trigger, homing, emergency stop, velocity, etc as shown below
3. Set PR path parameter such as motion type, S-code, etc as shown below. The interface is divided into 3 parts:

Function buttons: Upload, download parameters to/from drives, save parameter, backup and reset to factory default.

Parameters: Set PR path related parameters here

Descriptions: Short explanation on each PR path motion types

Remember to upload parameters to drive and save to drive after parameters setup.

4. Set up homing, trigger, I/O in PR mode as shown below:

***Please select required path when using edge trigger. Make sure the corresponding path is chosen in I/O path selection*

**Please set up I/O combination filter time when using I/O combination trigger. Make sure I/O signal filter time covers the change in signal level.*

7.5.2 Control using 485 communication

485 communication data frame format

Byte (x)	0	1	2	3	4	5	6	7
Definition	ID	Function code	Addr. High 8-bit	Addr. Low 8-bit	Data High 8-bit	Data Low 8-bit	CRC checksum Low 8-bit	CRC checksum High 8-bit

Please refer to Modbus communication in Chapter 6 to use Word function code writing. The request and respond frame data format is similar.

1. Set PR0 to travel to absolute position = 200000 (10000 pulse/rev)

No.	485 communication data frame	Description
1	01 06 62 00 00 01 57 B2	Set PR0 mode as absolute position
2	01 06 62 01 00 03 87 B3	Set PR0 position high bit
3	01 06 62 02 0D 40 32 D2	Set PR0 position low bit
4	01 06 62 03 02 58 66 E8	Set PR0 velocity
5	01 06 62 04 00 32 56 66	Set PR0 acceleration
6	01 06 62 05 00 32 07 A6	Set PR0 deceleration
7	01 06 60 02 00 10 37 C6	Trigger PR0 motion
8	01 06 60 02 00 40 37 FA	Send Emergency stop datagram when required

2. Set PR0 to travel relative distance = 10000 (10000 pulse/rev)

No.	485 communication data frame	Description
1	01 06 62 00 00 41 56 42	Set PR0 mode as relative position
2	01 06 62 01 00 00 C7 B2	Set PR0 position high bit
3	01 06 62 02 27 10 2D 8E	Set PR0 position low bit
4	01 06 62 03 02 58 66 E8	Set PR0 velocity
5	01 06 62 04 00 32 56 66	Set PR0 acceleration
6	01 06 62 05 00 32 07 A6	Set PR0 deceleration
7	01 06 60 02 00 10 37 C6	Trigger PR0 motion
8	01 06 60 02 00 40 37 FA	Send Emergency stop datagram when required

3. Set PR0 as velocity mode with velocity = 600rpm

No.	485 communication data frame	Description
1	01 06 62 00 00 02 17 B3	Set PR0 as velocity mode
2	01 06 62 03 02 58 66 E8	Set PR0 velocity
3	01 06 62 04 00 32 56 66	Set PR0 acceleration
4	01 06 62 05 00 32 07 A6	Set PR0 deceleration
5	01 06 60 02 00 10 37 C6	Trigger PR0 motion
6	01 06 60 02 00 40 37 FA	Send Emergency stop datagram when required

4. Set PR1 to travel to absolute position = 200000 (10000 pulse/rev)

No.	485 communication data frame	Description
1	01 06 62 08 00 01 D6 70	Set PR1 mode
2	01 06 62 09 FF FC 07 C1	Set PR1 position high bit
3	01 06 62 0A F2 C0 F3 40	Set PR1 position low bit
4	01 06 62 0B 02 58 E7 2A	Set PR1 velocity
5	01 06 62 0C 00 32 D7 A4	Set PR1 acceleration
6	01 06 62 0D 00 32 86 64	Set PR1 deceleration
7	01 06 60 02 00 11 F6 06	Trigger PR1 motion
8	01 06 60 02 00 40 37 FA	Send Emergency stop datagram when required

5. Set PR1 as velocity mode with velocity = 300rpm

No.	485 communication data frame	Description
1	01 06 62 08 00 02 96 71	Set PR1 as velocity mode
2	01 06 62 0B 01 2C E7 FD	Set PR1 velocity
3	01 06 60 02 00 11 F6 06	Set PR1 acceleration
4	01 06 62 0C 00 32 D7 A4	Set PR1 deceleration
5	01 06 62 0D 00 32 86 64	Trigger PR1 motion
6	01 06 60 02 00 40 37 FA	Send Emergency stop datagram when required

6. Homing

No.	485 communication data frame	Description
1	01 06 60 0A 00 00 B7 C8	Set homing method
2	01 06 60 0F 00 64 A6 22	Set high homing velocity
3	01 06 60 10 00 1E 16 07	Set low homing velocity
4	01 06 60 02 00 20 37 D2	Trigger homing
5	01 06 60 02 00 40 37 FA	Send Emergency stop datagram when required

Chapter 8 Warning and Alarm

8.1 Servo Drive alarm indicator

Green LED: Power ON/Motor enable

ON for once: Power ON

Always ON: Motor Enable





Blinking: Motor Disable

OFF: Power OFF

Red LED: Alarm indicator (Motor stops when alarm indicator is ON)

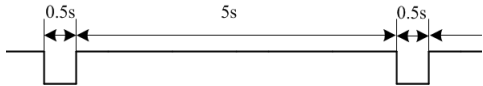
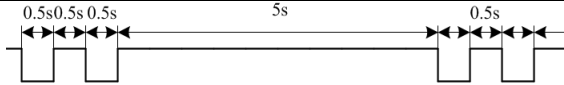
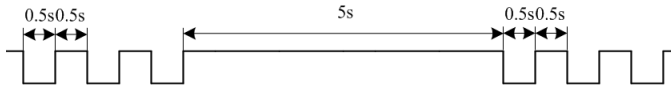
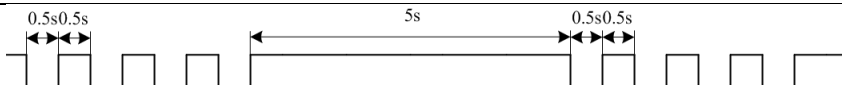
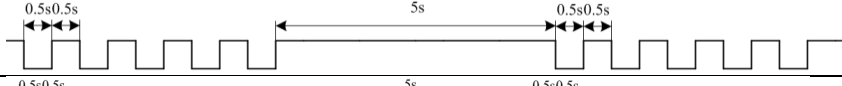
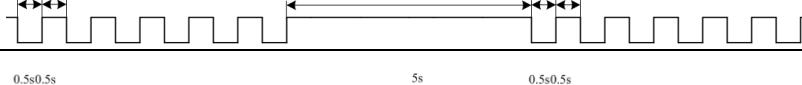
Blink for 5s/cycle (Please refer to the table below)

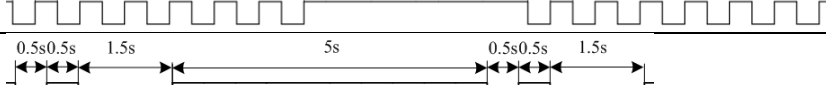
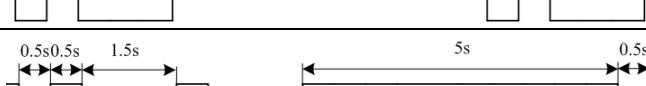
OFF: Alarm cleared

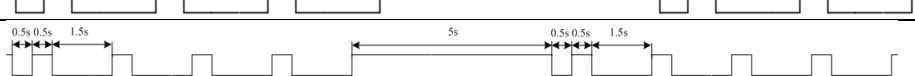
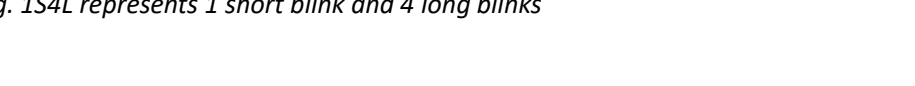
Error	Blink	Sequence	Error
0E1/ 0E0	1S		Hardware/software overcurrent
0C0/ 0D0	2S		Under-/overvoltage
81B	3S		CANopen communication timeout
0A3	4S		Motor phase missing
150/ 151	5S		Encoder error
100	6S		Overload
180	7S		Excessive position deviation
0F0	8S		Over-temperature
1A0/ 1A1	1S1L		Motor loses speed
0A0/ 0A1	1S2L		Hardware initialization error
240	1S3L		Parameter saving error
	1S4L		Other error

S: Short, L: Long. 1S4L represents 1 short blink and 4 long blinks

8.2 Servo drive alarm

Table 8.1 Error Code List

Error code		Content	Attribute		
Main	Sub		Save	E.Stop	Clearable
09	0~F	FPGA communication error	●		
0A	0~1	Circuit current detection error	●		
	2, 4	Analog input error	●		
	3	Motor power cable not connected	●		
	5	DC bus error	●		
	6	Temperature measuring error	●		
0b	0	Control circuit power supply voltage too low			
	1	Control circuit power supply voltage too high			●
0c	0	DC bus overvoltage	●		●
0d	0	DC bus undervoltage	●		●
0E	0	Overcurrent	●		
	1	Intelligent Power Module (IPM) overcurrent	●		
	2	Power output to motor shorted to ground	●		
	4	Phase overcurrent	●		
0F	0	Driver overheated	●	●	
10	0	Motor overloaded	●		●
	1	Driver overloaded	●		●
	2	Motor rotor blocked	●		●
12	0	Regenerative resistor overvoltage	●	●	
	1	Holding brake error	●		
	2	Regenerative resistor value too low	●		
15	0	Encoder disconnected	●		
	1	Encoder communication error	●		
	2	Encoder initial position error	●		
	3	Multiturn encoder error	●		
	4	Encoder parameter settings error	●		
	5	Encoder data overflow	●		●
	6	Encoder overheated	●		●
7	Encoder counter error	●		●	
17	0	Encoder data error	●	●	
	1	Encoder parameter initialization error	●		
18	0	Excessive position deviation	●	●	●
	1	Excessive velocity deviation	●	●	●
19	0	Motor vibration too strong	●	●	●
	1	Excessive hybrid position deviation	●		●
1A	0	Overspeed	●		●
	1	Velocity out of control	●		●
1b	0	Bus input signal dithering	●		●
	1	Incorrect electronic gear ratio	●		●
	4	Excessive synchronous position command	●		●
21	0	I/O input interface assignment error	●		

	1	I/O input interface function assignment error	•		
	2	I/O output interface function assignment error	•		
24	0	CRC correction during EEPROM parameter saving			
26	0	Positive/Negative position limit triggered under non-homing mode	•	•	•
27	0	Analog 1 input overrun limit	•		•
29	0	Control mode not match under full closed loop mode	•		
	1	Encoder mode not match under full closed loop mode	•		
57	0	Forced alarm input valid(E-stop)	•	•	•
5F	0	Motor model no. detection error			
	1	Driver power module detection error			
60	0	Main loop interrupted timeout			
	1	Velocity loop interrupted timeout			
70	0	Encryption error			
88	0	Communication timeout	•	•	
89	0	Homing error			•

8.3 Alarm Handling

***When error occurs, please solve accordingly. Then, restart. If the solutions described don't work, please consider replacing the driver.*

Error code	Main	Sub	Display: "Er 090"--"Er 09F"	
	09	0~F	Content: FPGA communication error	
Cause			Diagnosis	Solution
DC-,DC+ terminal voltage too low			Verify DC-,DC+ terminal voltage	Make sure DC-,DC+ terminal voltage is within recommended range

Error code	Main	Sub	Display: "Er 0A0"--"Er 0A1"	
	0A	0~1	Content: Circuit current detection error	
Cause			Diagnosis	Solution
Motor power cable wiring error			Verify motor power cable wiring	Make sure U,V,W terminal wired properly
Main power supply undervoltage			Verify DC-,DC+ terminal voltage	Increase main power supply voltage

Error code	Main	Sub	Display: "Er 0A2" / "Er 0A4"	
	0A	2 / 4	Content: Analog input error	
Cause			Diagnosis	Solution
Analog input wiring error			Verify analog input wiring	Make sure of analog input wiring connection

Error code	Main	Sub	Display: "Er 0A3"
	0A	3	Content: Motor power cable not connected
Cause			Diagnosis
Motor power cable not connected			Verify motor power cable wiring
			Measure resistance values between U, V, W terminals , make sure the values are almost equal. If not, might be due to damaged motor or motor winding open circuit.
Motor fault			/
			Replace motor

Error code	Main	Sub	Display: "Er 0A5"
	0A	5	Content: DC Bus error
Cause			Diagnosis
DC-,DC+ terminal voltage too low			Verify DC-,DC+ terminal voltage. Check if power on indicator light on servo drive is on and d27 DC bus voltage.
			Make sure DC-,DC+ terminal voltage is within recommended range

Error code	Main	Sub	Display: "Er 0A6"
	0A	6	Content: Temperature measuring error
Cause			Diagnosis
DC-,DC+ terminal voltage too low			Verify DC-,DC+ terminal voltage
			Make sure DC-,DC+ terminal voltage is within recommended range

Error code	Main	Sub	Display: "Er 0c0"
	0c	0	Content: DC bus overvoltage
Cause			Diagnosis
Main power supply overvoltage			Verify DC-,DC+ terminal voltage
Acceleration/deceleration time too short			Verify if the time is actually too short
Regenerative brake parameter anomaly			Verify Pr7.32/Pr7.33
Inner brake circuit damaged			/
			Decrease main power supply voltage
			Increase the duration time or change to a regenerative resistor with higher resistance.
			Modify vent overload parameter
			Replace driver

Error code	Main	Sub	Display: "Er 0d0"
	0d	0	Content: DC bus undervoltage
Cause			Diagnosis
Main power supply undervoltage			Verify DC-,DC+ terminal voltage
			Increase main power supply voltage

Error code	Main	Sub	Display: "Er 0E0"
	0E	0	Content: Overcurrent
Cause			Diagnosis
Driver power output short circuit			Verify if there is short circuit between UVW terminals, or shorted to PG.
Motor wiring error			Verify motor wiring
IGBT module short circuit			Disconnect motor output cable. Then, enable servo driver to check for overcurrent
Control parameter anomaly			Verify if parameter exceeds recommended range
Control command anomaly			Verify if command motion is too acute
			Solution
Driver power output short circuit			1. Make sure there is no circuit. 2. Make sure motor is not damaged
Motor wiring error			Reconnect motor wiring
IGBT module short circuit			Replace driver
Control parameter anomaly			Set parameter within recommended range.
Control command anomaly			Modify control command; use filter

Error code	Main	Sub	Display: "Er 0E1"
	0E	1	Content: Intelligent Power Module (IPM) overcurrent
Cause			Diagnosis
Driver power output short circuit			Verify if there is short circuit between UVW terminals, or shorted to PG.
Motor wiring error			Verify motor wiring
IGBT module short circuit			Disconnect motor output cable. Then, enable servo driver to check for overcurrent
IGBT module undervoltage			/
Control parameter anomaly			Verify if parameter exceeds recommended range
Control command anomaly			Verify if command motion is too acute
			Solution
Driver power output short circuit			1. Make sure there is no circuit. 2. Make sure motor is not damaged
Motor wiring error			Reconnect motor wiring
IGBT module short circuit			Replace driver
IGBT module undervoltage			Replace driver
Control parameter anomaly			Set parameter within recommended range.
Control command anomaly			Modify control command; use filter

Error code	Main	Sub	Display: "Er 0F0"
	0F	0	Content: Driver overheated
Cause			Solution
Temperature of power module exceeded upper limit			1. Improve cooling condition. Please check installation guide; 2. Replace driver and motor with higher power rating; 3. Increase duration time for acceleration and deceleration; 4. Decrease load

Error code	Main	Sub	Display: "Er 100"
	10	0	Content: Motor overloaded
Cause		Diagnosis	Solution
Load too heavy		Verify if actual load exceeds maximum value allowed	1. Decrease load 2. Adjust limit values
Strong mechanical vibration		Look for mechanical vibration from machine system	1. Adjust gain value of control loop 2. Increase duration time for acceleration and deceleration
Motor or encoder cable wiring error		Verify motor and encoder wiring	1. Reconnect wiring 2. Replace motor and encoder cable
Holding brake engaged		Verify holding brake terminal voltage	Cut off holding brake

Error code	Main	Sub	Display: "Er 101"
	10	1	Content: Driver overloaded
Cause		Diagnosis	Solution
Motor power cable wiring error		UVW terminals wiring error	Make sure motor power cable wiring connection is correct
Motor not matched		Motor current is too high	Motor rated current is higher than driver rated current. Please change to a driver with higher rated current.

Error code	Main	Sub	Display: "Er 102"
	10	2	Content: Motor rotor blocked
Cause		Diagnosis	Solution
Motor rotor blocked		Look for mechanical blockages	Check the machinery
Motor rotor blocking time threshold value too low		Verify value of Pr6.57	Adjust value of Pr6.57

Error code	Main	Sub	Display: "Er 120"
	12	0	Content: Regenerative resistor overvoltage
Cause		Diagnosis	Solution
Regenerative energy exceeded capacity of regenerative resistor		1. Verify if velocity is too high 2. Verify if load is too large	1. Decrease motor rotational velocity; 2. Decrease load inertia; 3. Add an external regenerative resistor;
Power supply voltage too high		1. Verify if power supply voltage is within the rated range. 2. Interval regenerative resistor value is too low	1. Decrease power supply voltage 2. Increase regeneration resistance value(add external regenerative resistor)
Unstable power supply voltage		Verify if power supply voltage is stable	Add a surge suppressor to main power supply.
Regenerative energy discharge circuit damaged		/	1. Add an external regenerative resistor; 2. Replace driver

Error code	Main	Sub	Display: "Er 121"
	12	1	Content: Holding brake error
Cause			Diagnosis
Holding brake circuit damaged			Regenerative resistor disconnected
			Holding brake IGBT damaged
			Solution
			Replace regenerative resistor
			Replace driver

Error code	Main	Sub	Display: "Er 122"
	12	2	Content: Regenerative resistor value too low
Cause			Diagnosis
External regenerative resistor value is less than the minimum value allowed by the drive			/
			Solution
			Replace the regenerative resistor with the right resistance value which meets the specification of the driver

Error code	Main	Sub	Display: "Er 150"
	15	0	Content: Encoder disconnected
Cause			Diagnosis
Encoder cable disconnected			Verify encoder cable connection
Encoder cable wiring error			Verify if encoder wiring is correct
Encoder damaged			/
Encoder measuring circuit damaged			/
			Solution
			Make sure encoder cable properly connected
			Reconnect encoder wiring
			Replace motor
			Replace driver

Error code	Main	Sub	Display: "Er 151"
	15	1	Content: Encoder communication error
Cause			Diagnosis
Encoder wire shielding layer is missing			Verify if encoder cable has shielding layer
Encoder cable wiring error			Verify if encoder wiring is correct
Encoder damaged			/
			Solution
			Replace with standard encoder cable
			Reconnect encoder wiring
			Replace motor

Error code	Main	Sub	Display: "Er 152"
	15	2	Content: Encoder initial position error
Cause			Diagnosis
Communication data abnormal			1. Verify if encoder power supply voltage is $DC5V \pm 5\%$; 2. Verify if encoder cable and shielded layer is not damaged; 3. Verify if encoder cable is close to high-powered power supply cable
			Solution
			1. Make sure encoder power supply voltage is stable 2. Make sure encoder cable is not damaged. 3. Make sure encoder cable shielded layer is grounded to frame 4. Make sure encoder cable is away

		from high-powered power supply cable
Encoder damaged	/	Replace motor
Encoder measuring circuit damaged	/	Replace driver

Error code	Main	Sub	Display: "Er 153"
	15	3	Content: Multiturn encoder error
Cause		Diagnosis	Solution
Initial use		Origin calibration not performed	Perform origin positioning and multiturn position initialization, calibrate the origin of coordinate system.
Encoder without multiturn absolute function used		Verify if encoder has multiturn absolute function	1. Replace the motor with a multiturn absolute encoder. 2. Set Pr0.15 = 0 to deactivate multiturn absolute function.
Low battery power		Replace battery and restart driver to clear alarm	Replace battery
Battery has no power or has been dismantled		Alarm not cleared after replacing battery and restart	Absolute position lost. Return to origin and perform multiturn initialization, calibrate the origin of coordinate system

Error code	Main	Sub	Display: "Er 154"
	15	4	Content: Encoder parameter settings error
Cause		Diagnosis	Solution
Absolute encoder mode is incorrectly set.		Verify if encoder has multi-turn absolute value function.	Modify absolute encoder mode settings

Error code	Main	Sub	Display: "Er 155"
	15	5	Content: Encoder data overflow
Cause		Diagnosis	Solution
Encoder data overflow		Verify if encoder is not damaged	Initialize multiturn data
Absolute value applications, motor rotates in one direction		Verify if encoder is not damaged	Adjust absolute value application mode, set to turntable mode

Error code	Main	Sub	Display: "Er 156"
	15	6	Content: Encoder overheated
Cause		Diagnosis	Solution
The encoder temperature is too high.		Verify if motor temperature is too high	Reduce encoder temperature.

Error code	Main	Sub	Display: "Er 157"
		15	7
Cause		Diagnosis	Solution
Encoder data overflow		Verify if encoder is not damaged	Initialize multiturn data
Absolute value applications, motor rotates in one direction		Verify if encoder is not damaged	Adjust absolute value application mode, set to turntable mode

Error code	Main	Sub	Display: "Er 170"
		17	0
Cause		Diagnosis	Solution
Communication data abnormal		1. Verify if encoder power supply voltage is $DC5V \pm 5\%$; 2. Verify if encoder cable and shielded layer is not damaged; 3. Verify if encoder cable is close to high-powered power supply cable	1. Make sure encoder power supply voltage is stable 2. Make sure encoder cable is not damaged. 3. Make sure encoder cable shielded layer is grounded to frame 4. Make sure encoder cable is away from high-powered power supply cable
Encoder damaged		/	Replace motor
Encoder measuring circuit damaged		/	Replace driver

Error code	Main	Sub	Display: "Er 171"
		17	1
Cause		Diagnosis	Solution
Driver and motor not matched		Verify driver and motor models.	Replace with matching driver and motor
Error while getting parameters from encoder		1. Verify if encoder cable is standard. 2. Verify if encoder has no peeled insulator, broken connection or improper contact.	Use standard encoder cable, verify the connection of both sides of driver and motor, change encoder cable if necessary

Error code	Main	Sub	Display: "Er 180"
		18	0
Cause		Diagnosis	Solution
Improper position deviation settings		Verify if value of Pr_014 is too low	Increase value of Pr_014
Position gain setting too low		Verify if values of Pr1.00 & Pr1.05 are too low	Increase values of Pr1.00 & Pr1.05
Torque limit too low		Verify if values of Pr0.13 & Pr5.22 are too low	Increase values of Pr0.13 & Pr5.22

Excessive external load	1. Verify if acceleration and deceleration duration time is too low. 2. Verify if rotational velocity is too high 3. Verify if load is too large	1. Increase duration time for acceleration and deceleration 2. Decrease rotational velocity 3. Decrease load
-------------------------	--	--

Error code	Main	Sub	Display: "Er 181"
	18	1	Content: Excessive velocity deviation
Cause		Diagnosis	Solution
Deviation between set velocity and actual velocity is too great		Verify if value of Pr6.02 is too low	1. Increase value of Pr6.02; 2. Set Pr6.02 to 0, position error detection off.
Acceleration and deceleration duration time for set velocity is too low		Verify if value of Pr3.12 and Pr3.13 are too low	1. Increase value of Pr3.12, Pr3.13; 2. Adjust velocity gain to reduce velocity lag error

Error code	Main	Sub	Display: "Er 190"
	19	0	Content: Vibration too strong
Cause		Diagnosis	Solution
Resonance		Mechanical stiffness is too high, resonance occurs	Reduce mechanical stiffness or use filter
Current loop gain too large		Verify current loop gain value	Reduce current loop gain

Error code	Main	Sub	Display: "Er 191"
	19	1	Content: Excessive hybrid position deviation
Cause		Diagnosis	Solution
Driver UVW terminal output single phasing or wiring error		Verify if UVW terminal wiring connection is right	Make sure UVW terminals are correctly connected to UVW of motor; change motor power cable.
Motor rotor blocked		Look for mechanical blockages	Check the machinery
Driver stiffness too low		Verify if position loop and velocity loop gain is too low	Increase position loop and velocity loop gain
Full closed loop position deviation (Deviation between external encoder feedback position and motor feedback position) exceeds Pr0.33		Verify if Pr0.33 is set too low	Increase Pr0.33 set value accordingly but please aware that doing so might cause the position deviation to be higher.

Error code	Main	Sub	Display: "Er 1A0"
	1A	0	Content: Overspeed
Cause		Diagnosis	Solution
Motor velocity exceeded first speed limit (Pr3.21)		1. Verify if velocity command is too high; 2. Verify if simulated velocity command voltage is too high; 3. Verify if parameter value of Pr3.21 is too low; 4. Verify if input frequency and division frequency coefficient of pulse train is proper; 5. Verify if encoder is wired correctly	1. Adjust velocity input command; 2. Increase Pr3.21 value; 3. Adjust pulse train input frequency and division frequency coefficient; 4. Verify encoder wiring;

Error code	Main	Sub	Display: "Er 1A1"
	1A	1	Content: Velocity out of control
Cause		Diagnosis	Solution
Motor velocity out of control, Excessive velocity error		Verify encoder phase sequence; Verify if UVW cable is connected to the right terminal	Reconnect UVW if wrongly connected. If still remains unsolved, please contact technical support.

Error code	Main	Sub	Display: "Er 1b0"
	1b	0	Content: Bus input signal dithering
Cause		Diagnosis	Solution
Controller synchronization dithering		/	Increase alarm threshold value

Error code	Main	Sub	Display: "Er 210"
	21	0	Content: I/O input interface assignment error
Cause		Diagnosis	Solution
Input signal assigned with two or more functions.		Verify values of Pr4.00-Pr4.09, Pr4.44-4.47	Set proper values for Pr4.00-Pr4.09, Pr4.44-4.47

Error code	Main	Sub	Display: "Er 211"
	21	1	Content: I/O input interface function assignment error
Cause		Diagnosis	Solution
Input signal assignment error		Verify values of Pr4.00-Pr4.09, Pr4.44-4.47	Set proper values for Pr4.00-Pr4.09, Pr4.44-4.47

Error code	Main	Sub	Display: "Er 212"
	21	2	Content: I/O output interface function assignment error
Cause			Diagnosis
Input signal assigned with two or more functions.			Verify values of Pr4.10-Pr4.15
Input signal not assigned			Verify values of Pr4.10-Pr4.15
			Solution
			Set proper values for Pr4.10-Pr4.15
			Set proper values for Pr4.10-Pr4.15

Error code	Main	Sub	Display: "Er 240"
	24	0	Content: CRC correction error during EEPROM parameter saving
Cause			Diagnosis
r, t terminal voltage too low			Verify if r, t terminal voltage too low
Parameter saving anomaly			Save parameter again and restart
			Solution
			Make sure r, t terminal voltage is within recommended range
			Save parameter again

Error code	Main	Sub	Display: "Er 260"
	26	0	Content: Positive/Negative position limit triggered under non-homing mode
Cause			Diagnosis
Positive/negative position limit triggered			Verify position limit signal
			Solution
			/

Error code	Main	Sub	Display: "Er 270" -- "Er 272"
	27	0~2	Error description: Analog input 1-3 out of range
Cause			Diagnosis
Analog value out of range			Verify if analog input value is out of range
			Solution
			Adjust analog input voltage

Error code	Main	Sub	Display: " Er 570"
	57	0	Error description: Forced alarm input valid
Cause			Diagnosis
Forced alarm input signal occurred			Verify forced alarm input signal
			Solution
			Verify if the input wiring connection is correct

Error code	Main	Sub	Display: "Er 5F0"
	5F	0	Content: Motor model no. detection error
Cause			Diagnosis
Automatically detected motor doesn't match set motor			/
			Solution
			Please contact our technical support

Error code	Main	Sub	Display: "Er 5F1"
	5F	1	Error description: Driver power module detection error
Cause		Diagnosis	Solution
Driver power rating not within range.		Restart driver	Please contact our technical support

Error code	Main	Sub	Display: "Er 600"
	60	0	Error description: Main loop interrupted timeout
Cause		Diagnosis	Solution
The motor control loop calculation time overflow		Check for interference from devices releasing electromagnetic field	Ground driver and motor to reduce interference
		Restart driver	Replace driver

Error code	Main	Sub	Display: "Er 601"
	60	1	Error description: Velocity loop interrupted timeout
Cause		Diagnosis	Solution
Motor control loop calculation time overflow		Verify if encoder connection is and that the encoder cable is too not long (more than 20 meters)	Replace encoder cable if necessary
		Restart driver	Replace the drive with a new one

Error code	Main	Sub	Display: "Er 700"
	70	0	Error description: Encryption error
Cause		Diagnosis	Solution
Encryption error during initialization upon power-on.		Restart driver	Please contact our technical support

Error code	Main	Sub	Display: "Er 880"
	88	0	Error description: Modbus communication timeout
Cause		Diagnosis	Solution
Communication timeout		Please check if the communication cable is properly connected	Make sure the communication connection is secured

Error code	Main	Sub	Display: "Er 890"
	89	0	Error description: Homing error
Cause		Diagnosis	Solution
1. Excess homing velocity 2. Homing mode is different from given signal 3. Sensor signal edge inconsistent		1. Verify if homing velocity is too high 2. Verify if homing mode is set correctly 3. Verify if sensor signal edge is consistent	1. Set an optimal homing velocity 2. Make sure sensor signal edge is consistent.
Inconsistent origin status		1. Homing acceleration/ deceleration is set too low 2. Electronic gear ratio is low which causes acceleration/ deceleration to be too low	1. If electronic gear ratio cannot be changed, please set a suitable 609A. 2. Increase electronic gear ratio

8.4 Alarm clearing

8.4.1 Servo Drive Alarm Clearing

Clearable Alarm

Please clear alarm using Motion Studio after solving the error by clicking on the "Clear" button.

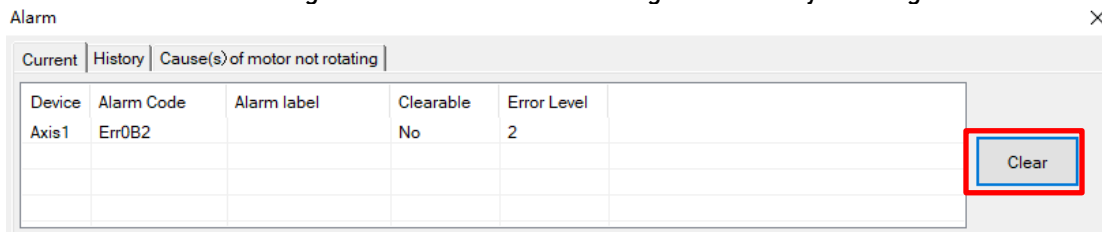

Non-clearable Alarm

Please restart drive to clear alarm

Contact Us

Leadshine Technology Co., Ltd.

Headquarters

Address:
15-20/F, Block B, Nanshan I Valley, No.3157, Nanshan District,
Shenzhen City, Guangdong Province, China
Tel:
+86 755 26411692
Fax:
+86 755 26402718
Website:
www.leadshine.com
Emails:
sales@leadshine.com

Leadshine Global Retailers Network



Get in touch with us or any of your local Leadshine certified retailers by visiting our global website.

Technical Support

Tel: 86-755-2641-8447
86-755-2641-8774 (Asia, Australia, Africa)
86-755-2665-5136 (North and South America)
86-755-8654-2465 (Europe)
Fax: 86-755-2640-2718
Email: tech@leadshine.com

Sales Hot Line

Tel: 86-755-2641-7674 (Asia, Australia, Africa)
86-755-2641-7617 (North and South America)
86-755-2640-9254 (Europe)
Email: sales@leadshine.com

Leadshine Overseas



Leadshine America, Inc.

North America
Office

Address:
26050 Towne
Centre Dr.
Foothill
Ranch California
United States
Tel:
1-949-608-7270
Fax:
1-949-638-7298
Website:
www.leadshineusa.com
Emails:
sales@leadshineusa.com