



Precision in Productivity™

FOCUSED



INSIGHTFUL



COMPREHENSIVE



GLOBAL

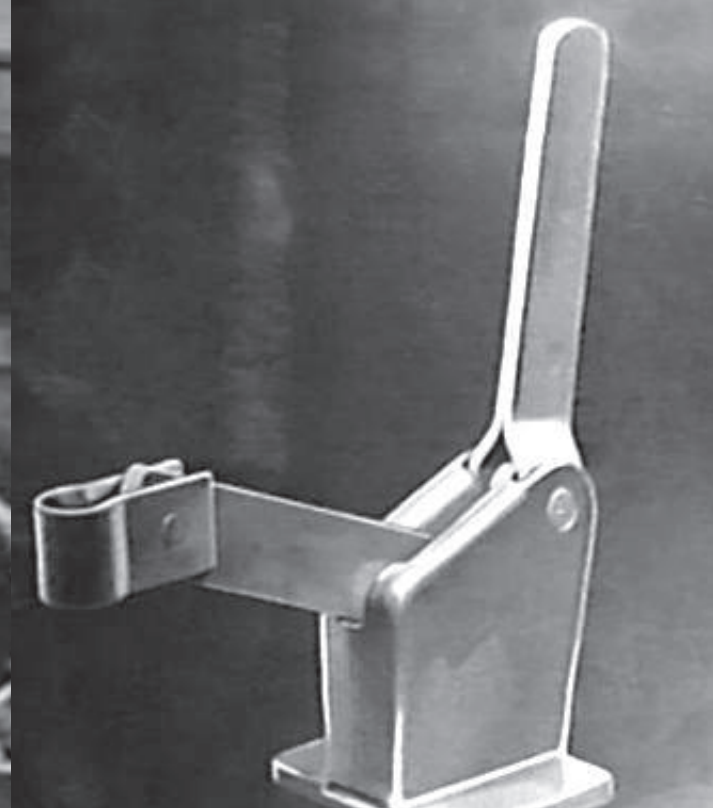

A LEGACY OF PERFORMANCE AND DEPENDABILITY

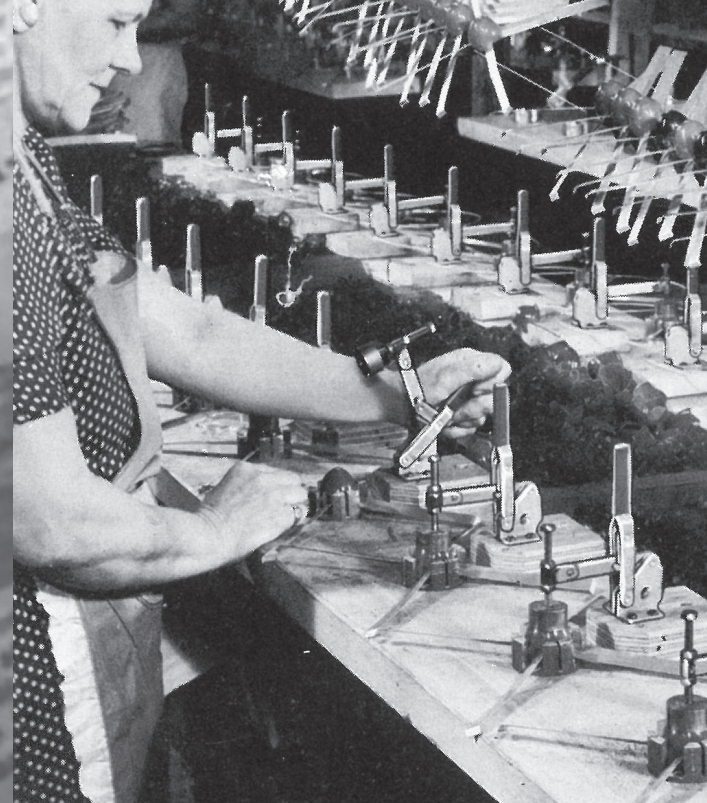
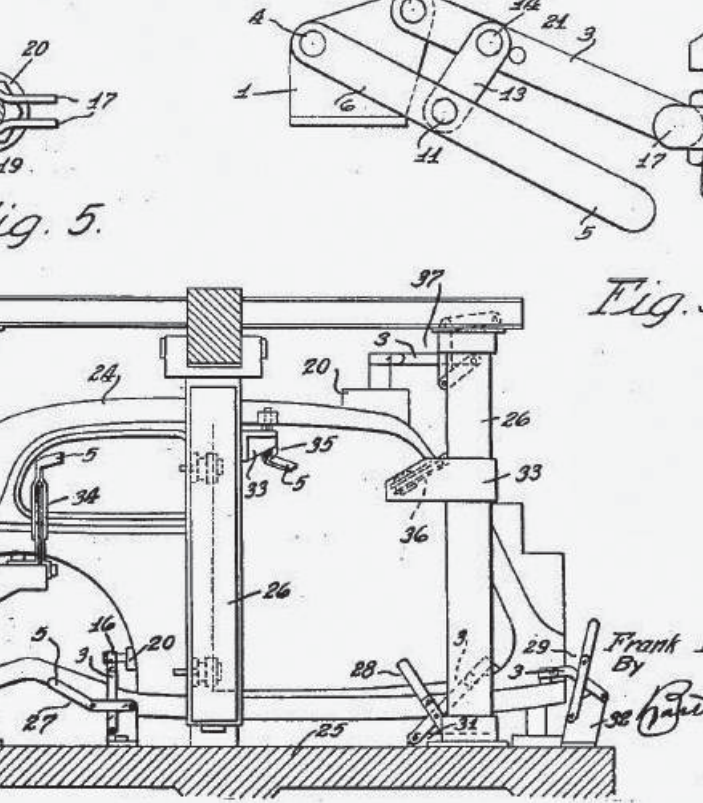

For more than 100 years, we've dedicated all of our talent and resources to helping manufacturers around the world achieve unparalleled precision and productivity through high-performance automation and workholding solutions.

Wherever manufacturing meets quality, you'll find DESTACO right at the point of precision.



Industrial



Food & Packaging



Transportation

COMPLETE SOLUTIONS FOR ALL INDUSTRIES



Consumer Goods



Aerospace



Life Sciences

Our complete line of high-performance automation and workholding products is simply unmatched.

The depth of our products allows us to develop creative solutions across a wide variety of markets and industries, enabling improved design flexibility and efficiency, reducing scrap, and ultimately improving manufacturing productivity at your facility.



North America



Europe



South America

WHENEVER AND WHEREVER YOU NEED US, **WE'RE THERE.**



Our global footprint was strategically developed to allow our experts to be available wherever you are. Our far-reaching network of sales and production locations gives you access to unrivaled customer and technical support.

We're working around the globe, and we're available whenever you need us. Our team is dedicated to helping you overcome the unique manufacturing challenges you face each and every day.

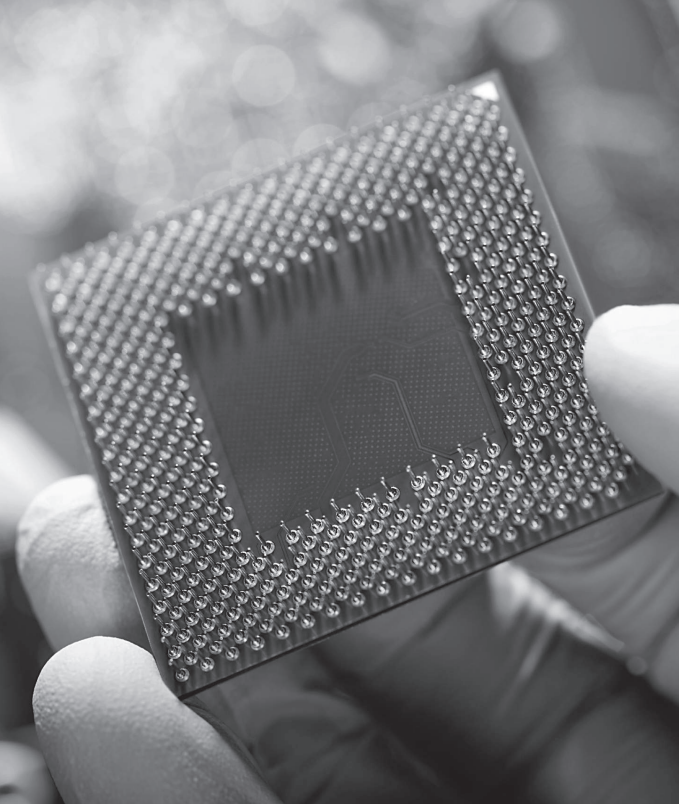

PERSPECTIVE IN PRODUCTION



Our technically skilled experts work side by side with manufacturers across all industries, in all key regions of the world, to provide production insight and perspective that our competitors simply can't match.

From anticipating and responding to evolving market conditions to identifying and overcoming technology roadblocks, we bring an experienced perspective to help our customers improve precision and optimize productivity.



**PRODUCTIVITY AND QUALITY,
RIGHT AT THE POINT OF PRECISION.**



End Effectors

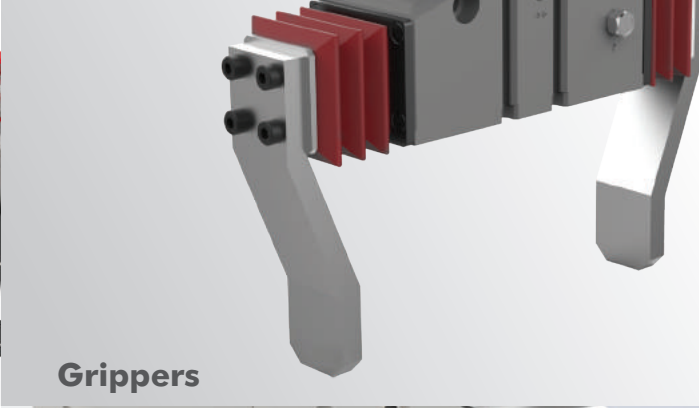

Grippers



Indexers



Manual Clamps



Power Clamps



Remote Handling

OUR PORTFOLIO OF **PRODUCTS**

The industry's most comprehensive line of high-performance automation and workholding solutions is ideal for a wide range of applications. For unique challenges, DESTACO's dedicated engineering service team will modify existing products or create entirely new solutions to meet your production needs.



End Effectors

- Tool Changers
- End-of-Arm Tooling
- Vacuum Products
- Palletizing Solutions



Grippers

- Electric Grippers
- Pneumatic and Sheet Metal Grippers
- Rotates
- Slides

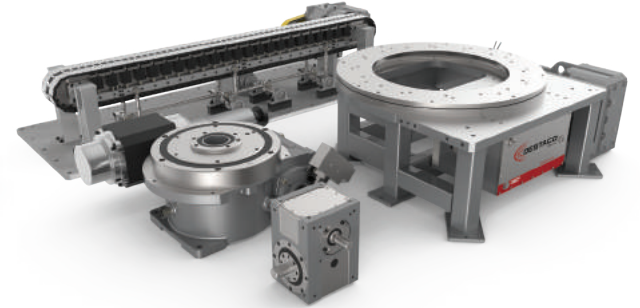

Indexers

- Precision Conveyors
- Dial Indexers
- Shaft and Flange Indexers
- Part Handlers



CUSTOM SOLUTIONS

If our off-the-shelf solutions don't fit, we can provide custom products that will.



Manual Clamps

- Hold Down
- Squeeze Action
- Plunger, Hook and Latch
- Pneumatic Toggle and Swing

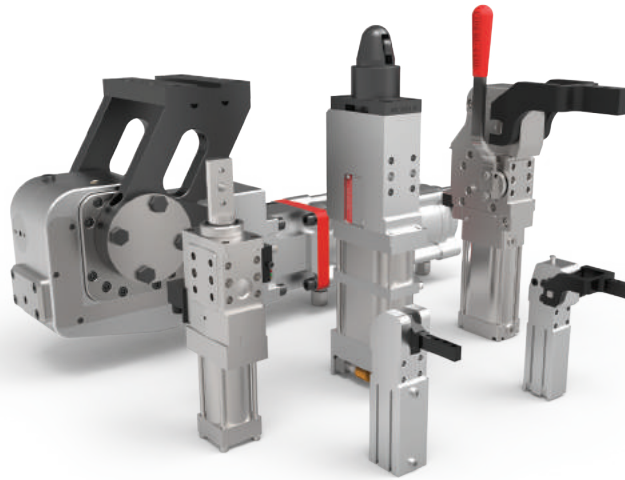

Power Clamps

- Power Clamps
- Pin Clamps and Packages
- Pivot Units
- Power Cylinders



Remote Handling

- Gloveport Systems
- Transfer Systems
- Telemanipulators
- Waste Drum Systems



ELECTRIC SOLUTIONS

DESTACO has some bright ideas when it comes to electric products.

GLOBAL LOCATIONS



destaco.com

© Copyright 2016 DESTACO. All rights for layout, photos and text rest with the publisher DESTACO. All photomechanical or other reproductions only with our express permission. All sales are based on our terms and conditions of sale, delivery and payment.

NORTH AMERICA

DESTACO Headquarters

Auburn Hills, Michigan
Tel: 1-248-836-6700
Toll Free: 1-888-DESTACO
Customer Service: northamerica@destaco.com

EUROPE

DESTACO Europe GmbH

Tel: +49-6171-705-0
Customer Service: europe@destaco.com

ASIA

DESTACO Asia

Tel: +66-2-326-0812
Customer Service: asia@destaco.com

SOUTH AMERICA

DESTACO Brazil

Tel: 0800-124070
Customer Service: southamerica@destaco.com

Global sales and marketing:
marketing@destaco.com



DSC_CORP_B_0116_US

Precision in Productivity™