

SU6 safety module Manual

en-US
04/2023
ID 443258.01



STÖBER

Table of contents

- Table of contents 2**
- 1 Foreword 5**
- 2 User information 6**
 - 2.1 Storage and transfer 6
 - 2.2 Described product 6
 - 2.3 Timeliness 6
 - 2.4 Original language 6
 - 2.5 Limitation of liability 6
 - 2.6 Formatting conventions 7
 - 2.6.1 Display of safety instructions 7
 - 2.6.2 Markup of text elements 8
 - 2.6.3 Mathematics and formulas 8
 - 2.7 Trademarks 9
 - 2.8 Explanation of terms 9
- 3 General safety instructions 10**
 - 3.1 Standards 10
 - 3.2 EU declaration of conformity 10
 - 3.3 Qualified personnel 10
 - 3.4 Intended use 11
 - 3.5 Decommissioning 11
- 4 Safety module SU6 12**
- 5 System design and function 13**
- 6 Technical data 15**
- 7 What you should know before commissioning 16**
 - 7.1 Program interfaces 16
 - 7.1.1 DS6 program interface 16
 - 7.1.2 TIA Portal program interface 20
 - 7.2 Meaning of parameters 22
 - 7.2.1 Parameter groups 22
 - 7.2.2 Parameter types and data types 23
 - 7.2.3 Parameter types 24
 - 7.2.4 Parameter structure 24
 - 7.2.5 Parameter visibility 25
 - 7.3 Signal sources and process data mapping 26
 - 7.4 Non-volatile memory 26

8	Commissioning	27
8.1	SU6: Assign the PROFIsafe destination address	28
8.2	Recommended time settings.....	28
8.3	DS6: Configuring the drive controller	29
8.3.1	Initiating the project	29
8.3.2	Parameterizing general PROFINET settings	30
8.3.3	Calculating checksum F_iPar_CRC	31
8.3.4	Transmitting and saving the configuration	32
8.4	TIA Portal: Configuring the safety technology.....	34
8.4.1	Installing the GSD file.....	34
8.4.2	Projecting the PROFINET network	35
8.4.3	Configuring the controller	37
8.4.4	Configuring the drive controller	39
8.4.5	Transmitting the configuration	47
8.4.6	Testing communication	48
8.5	Checking safety functions.....	49
9	Diagnostics	50
9.1	LED display.....	50
9.1.1	PROFINET state	50
9.1.2	PROFIsafe status	51
9.1.3	PROFINET network connection.....	52
9.2	Parameters	53
9.2.1	E54 Information safety module G6 V0	53
9.2.2	E67 STO state G6 V1	53
9.2.3	S40 PROFIsafe state SI6 V1	54
9.2.4	S41 PROFIsafe address SI6 V1.....	54
9.2.5	S42 Safety control word 1 SI6 V0.....	54
9.2.6	S43 Safety status word 1 SI6 V0	55
9.2.7	S45 PROFIsafe diagnosis SI6 V1	55
9.2.8	S46 PROFIsafe watch dog time SI6 V0	55
9.2.9	S47 PROFIsafe SS1-time SI6 V1.....	55
9.3	Events	56
9.3.1	Event 50: Safety module.....	56
9.3.2	Event 70: Parameter consistency	57

- 10 More information on PROFIsafe, safety functions and SU6? 58**
 - 10.1 PROFIsafe..... 58
 - 10.1.1 PROFIsafe telegram 30 59
 - 10.2 Safety functions..... 60
 - 10.2.1 Safe Torque Off – STO..... 60
 - 10.2.2 Safe Stop 1 – SS1-t..... 61
 - 10.3 SU6: Assign the PROFIsafe destination address 63
 - 10.4 Safety system time 64
 - 10.5 Watchdog time 64

- 11 Appendix..... 65**
 - 11.1 Standard telegrams 65
 - 11.1.1 Standard telegram 30: Process data 65
 - 11.2 Detailed information 66
 - 11.3 Formula symbols 67
 - 11.4 Abbreviations 67

- 12 Contact 68**
 - 12.1 Consultation, service and address..... 68
 - 12.2 Your opinion is important to us..... 68
 - 12.3 Close to customers around the world 69

- Glossary 70**

- List of figures..... 74**

- List of tables..... 75**

1 Foreword

The SU6 safety module adds the **Safe Torque Off (STO)** and **Safe Stop 1 (SS1)** safety functions, both described as standard in EN 61800-5-2, to STOBER drive controllers of the SC6 and SI6 series.

STO prevents an electrical rotating magnetic field, needed for the operation of synchronous or asynchronous motors, from being generated in a drive controller immediately once the safety function has been activated. In the case of SS1-t, the switch-off happens after a configurable amount of time.

For a combination consisting of a drive controller and SU6 safety module, the STO and SS1 safety functions are actuated via PROFINET (PROFIsafe).

SU6 is a fast and wear-free fully electronic solution. The safety module is designed so that regular system tests that interrupt operation are eliminated. In practical terms, this means increased availability of machines and systems. The often complex planning and documentation of function tests are also eliminated.

Drive controllers with an integrated safety module can be used in systems with high safety requirements up to SIL 3, PL e, category 4. Compliance with standard requirements has been certified by an independent testing institute as part of type-examination.

The SC6 and SI6 series drive controllers successfully passed the PROFINET as well as PROFIsafe conformance test. There, the communication interface was tested to ensure the reliability and function of the lower-level communication regardless of vendor.

2 User information

This documentation provides all information on the intended use of the drive controller in combination with the SU6 safety module.

2.1 Storage and transfer

As this documentation contains important information for handling the product safely and efficiently, it must be stored in the immediate vicinity of the product until product disposal and be accessible to qualified personnel at all times.

Also pass on this documentation if the product is transferred or sold to a third party.

2.2 Described product

This documentation is binding for:

Drive controllers of the SC6 or SI6 series in combination with the SU6 safety module and DriveControlSuite (DS6) software in V 6.5-J or later and associated firmware in V 6.5-J-PN or later.

2.3 Timeliness

Check whether this document is the latest version of the documentation. We make the latest document versions for our products available for download on our website:

<http://www.stoeber.de/en/downloads/>.

2.4 Original language

The original language of this documentation is German; all other language versions are derived from the original language.

2.5 Limitation of liability

This documentation was created taking into account the applicable standards and regulations as well as the current state of technology.

No warranty or liability claims for damage shall result from failure to comply with the documentation or from use that deviates from the intended use of the product. This is especially true for damage caused by individual technical modifications to the product or the project configuration and operation of the product by unqualified personnel.

2.6 Formatting conventions

Orientation guides in the form of signal words, symbols and special text markups are used to emphasize specific information so that you are able identify it in this documentation quickly.

2.6.1 Display of safety instructions

Safety instructions are identified with the following symbols. They indicate special risks when handling the product and are accompanied by relevant signal words that express the extent of the risk. Furthermore, useful tips and recommendations for efficient, error-free operation are specially highlighted.

ATTENTION!

Attention

This indicates that damage to property may occur

- if the stated precautionary measures are not taken.

⚠ CAUTION!

Caution

This word with a warning triangle indicates that minor personal injury may occur

- if the stated precautionary measures are not taken.

⚠ WARNING!

Warning

This word with a warning triangle means there may be a considerable risk of fatal injury

- if the stated precautionary measures are not taken.

⚠ DANGER!

Danger

This word with a warning triangle indicates that there is a considerable risk of fatal injury

- if the stated precautionary measures are not taken.

Information

Information indicates important information about the product or serves to emphasize a section in the documentation that deserves special attention from the reader.

2.6.2 Markup of text elements

Certain elements of the continuous text are distinguished as follows.

Important information	Words or expressions with a special meaning
Interpolated position mode	Optional: File or product name or other name
<u>Detailed information</u>	Internal cross-reference
http://www.samplelink.com	External cross-reference

Software and other displays

The following formatting is used to identify the various information content of elements referenced by the software interface or a drive controller display, as well as any user entries.

Main menu Settings	Window names, dialog box names, page names or buttons, combined proper nouns, functions referenced by the interface
Select Referencing method A	Predefined entry
Save your <own IP address>	User-defined entry
EVENT 52: COMMUNICATION	Displays (status, messages, warnings, faults)

Keyboard shortcuts and command sequences or paths are represented as follows.

[Ctrl], [Ctrl] + [S]	Key, shortcut
Table > Insert table	Navigation to menus/submenus (path specification)

2.6.3 Mathematics and formulas

The following signs are used to represent mathematical relationships and formulas.

–	Subtraction
+	Addition
×	Multiplication
÷	Division
	Absolute value

2.7 Trademarks

The following names used in connection with the device, its optional equipment and its accessories are trademarks or registered trademarks of other companies:

PROFIBUS [®] , PROFINET [®]	PROFIBUS [®] and PROFINET [®] are registered trademarks of PROFIBUS Nutzerorganisation e.V., Karlsruhe, Germany.
PROFIdrive [®] , PROFIsafe [®]	PROFIdrive [®] and PROFIsafe [®] are registered trademarks of Siemens AG, Munich, Germany.
SIMATIC [®] , TIA Portal [®]	SIMATIC [®] and TIA Portal [®] are registered trademarks of Siemens AG, Munich, Germany.

All other trademarks not listed here are the property of their respective owners.

Products that are registered as trademarks are not specially indicated in this documentation. Existing property rights (patents, trademarks, protection of utility models) are to be observed.

2.8 Explanation of terms

As relevant standards and products of other manufacturers are referenced, different manufacturer- or standard-specific names are used for the same term in this documentation.

For improved understandability, the names in this documentation are standardized to the terminology of STOBER to the greatest extent possible. The correlation of STOBER names to other sources can be found in the following table.

STOBER	PROFINET	PROFIsafe
Controller	IO controller	F-CPU, F-host
Drive controller	IO device	F-device, F-slave

Tab. 1: Correlation of STOBER terminology to PROFINET and PROFIsafe

3 General safety instructions

There are risks associated with the product described in this documentation that can be prevented by complying with the described warning and safety instructions as well as the included technical rules and regulations.

3.1 Standards

The following standards are relevant to the product specified in this documentation:

- EN ISO 13849-1:2015
- EN ISO 13849-2:2012
- EN 61800-5-2:2017
- EN 61508-x:2010
- EN 60204-1:2018
- EN 62061:2005 + Cor.:2010 + A1:2013 + A2:2015
- IEC 61784-3:2016

Subsequent references to the standards do not specify the respective year in order to improve readability.

3.2 EU declaration of conformity

We, STÖBER Antriebstechnik GmbH + Co. KG, declare that the products described in this document correspond the requirements of the guidelines of the European Parliament and of the Council.

Representatives: Stephan Scholze, STÖBER Antriebstechnik GmbH + Co. KG, Kieselbronner Str. 12, 75177 Pforzheim, Germany.

Complete product-specific EU declaration of conformity can be found at <http://www.stoeber.de/en/downloads/> or you can obtain it from our service department.

3.3 Qualified personnel

In order to be able to perform the tasks described in this documentation, the persons instructed to perform them must have the appropriate professional qualification and be able to assess the risks and residual hazards when handling the products. For this reason, all work on the products as well as their operation and disposal may be performed only by professionally qualified personnel.

Qualified personnel are persons who have acquired the authorization to perform these activities either through training to become a specialist and/or instruction by specialists.

Furthermore, valid regulations, legal requirements, applicable basic rules, this documentation and the safety instructions included in it must be carefully read, understood and observed.

3.4 Intended use

The SU6 safety module can be combined with STOBER drive controllers of the SC6 or SI6 series.

If a drive controller with the integrated SU6 safety module is used in a safety-related application, the safety module must be activated by a safety relay or a safety controller.



Electrical voltage! Risk of fatal injury due to electric shock!

An active STO safety function only means that generation of the rotating magnetic field at the motor has been interrupted. The motor may still be energized with dangerous high voltages.

- Make sure that persons cannot come into contact with conductive parts.
- If the supply voltage must be switched off, observe the requirements of EN 60204-1.

Improper use

The safety module may not be operated outside of the drive controller or operated not in compliance with the applicable technical specifications.

Information

An emergency off in accordance with EN 60204-1 is not possible with the SU6 safety module!
Observe this standard regarding the difference between **emergency off** and **emergency stop** in conjunction with **Safe Torque Off**.

Modification

As the user, you may not make any technical or electrical modifications to the SU6 safety module. Any removal of the module from the drive controller as well as any attempt at repair or replacement is prohibited.

Maintenance

The safety module does not require maintenance.

3.5 Decommissioning

In safety-oriented applications, note the mission time $T_M = 20$ years in the safety-relevant key performance indicators. A drive controller with integrated safety module must be taken out of operation 20 years after the production date. The production date of the drive controller is found on the accompanying nameplate.

4 Safety module SU6

The SU6 safety module adds the STO (Safe Torque Off) and SS1 (Safe Stop 1) safety functions to the drive controller. The module prevents the formation of a rotating magnetic field in the power unit of the drive controller and, in the event of an error or by external request, switches the drive controller to the STO state immediately or after a time delay (SS1-t).

Features

- Possible safety functions:
 - Safe Torque Off – STO in accordance with EN 61800-5-2
 - Stop category 0 in accordance with EN 60204-1
 - Safe Stop 1 (time-delayed) – SS1-t in accordance with EN 61800-5-2
 - Stop category 1 in accordance with EN 60204-1
- Activation of the safety functions using PROFIsafe
- STO switch-off time: < 60 ms
- Free of wear

Certifications in accordance with EN 61800-5-2 and EN ISO 13849-1

- Safety Integrity Level (SIL) 3
- Performance Level (PL) e
- Category 4

5 System design and function

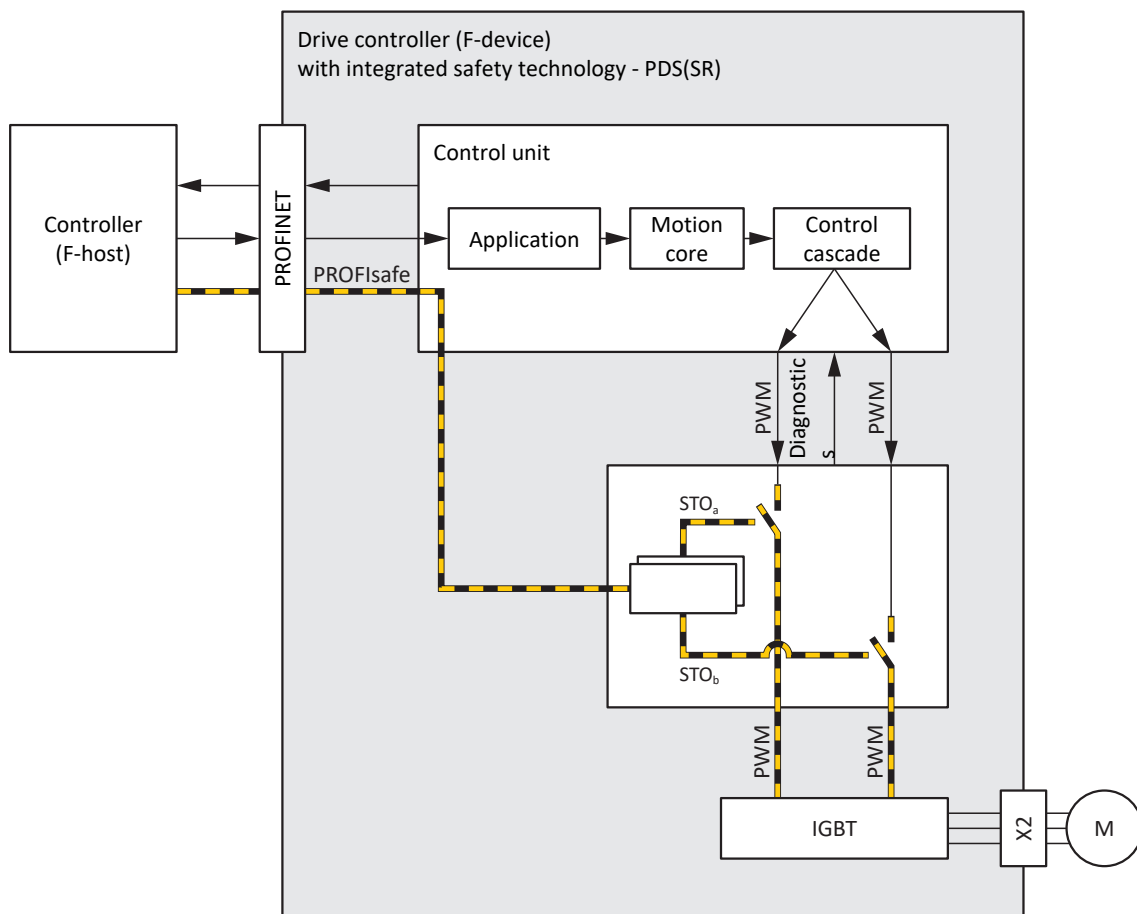

Fig. 1: Components of the PROFIsafe-based safety concept

System components

Central components of the PROFIsafe-based safety concept are:

- Drive controller (F-device) with integrated SU6 safety module
... for implementing the STO and SS1-t safety functions
- Controller (F-host) with integrated F-CPU
... for organizing all network communication
... for PROFIsafe communication and logic gate links between PROFIsafe nodes; the safety controller includes certified safety function modules that can be configured to the specific application using suitable automation software
- PROFIsafe protocol
... for the transmission of safety-related data
- PROFINET
... as the underlying fieldbus system

Function

The control unit of the drive controller generates pulse patterns (PWM) to produce a rotating magnetic field at the IGBT module in the power unit. This rotating magnetic field is necessary for operating synchronous and asynchronous motors.

If the STO safety function is not active, the SU6 safety module allows for the generation of a rotating magnetic field in the power unit; the connected motor can create a rotating magnetic field. If the safety function is active, the SU6 safety module disables the generation of the rotating magnetic field in the power unit and the drive controller cannot generate any torque in the connected motor.

The drive controller exchanges control and status information with the PROFIsafe controller via the SU6 safety module in accordance with the black channel principle. The drive controller extracts the safety-related data, checks it for plausibility and enables or disables the two safety channels in the power unit.

The STO and SS1-t safety functions relate to the device and are not axis-specific. On double-axis controllers, both axes are brought to a safe state at the same time. An activated SS1-t cannot be interrupted.

DANGER!

Risk of fatal injury due to gravity-loaded vertical axes or motor coasting!

The drive controller in the motor cannot generate torque when the STO safety function is active. Consequently, vertical axes subject to gravitational forces may fall. If the motor is moving when STO is activated, it will coast uncontrolled.

- Secure gravity-loaded vertical axes by braking or taking similar actions.
- Make sure that the motor coasting does not create any hazards.

WARNING!

Increased overrun distance! Residual motion!

The safety module cannot prevent a failure of the functional part of the drive controller (e.g. during a controlled stop) while the SS1-t safety function is executed. Therefore, SS1-t cannot be used if this failure could cause a dangerous situation in the end application. Observe this during project configuration.

In the event of an error in the power unit of the drive controller, static energization of the motor is possible despite active STO. In this case, the motor shaft can move by an angle of up to $360^\circ \div (p \times 2)$.

6 Technical data

The following table contains the key figures relevant to safety technology for the SU6 safety module.

SIL CL	3
SIL	3
PL	e
Category	4
PFHD	5×10^{-9} [1/h]
Mission time (TM)	20 years
STO switch-off time	< 60 ms
SS1 delay time	10 – 655350 ms ($\pm 1\%$)

Tab. 2: SU6 – Key safety-related figures

Information

The cycle time of the SU6 safety module is 12 ms, during which deactivation by SS1-t takes place in a 12 ms pattern and an additional delay of up to 10 ms can occur.

With a SS1 delay time of 10 ms (50 ms), the axis is stopped after 12 ms (60 ms).

7 What you should know before commissioning

The following chapters provide a quick introduction to the structure of the program interface and accompanying window designations as well as relevant information about parameters and generally saving your project configuration.

7.1 Program interfaces

The following chapters include an overview of the program interfaces for the described software components.

7.1.1 DS6 program interface

Using the graphical interface of the DriveControlSuite commissioning software (DS6), you can project, parameterize and commission your drive project quickly and efficiently. In case of service, you can evaluate diagnostic information such as operating states, fault memories and fault counters of your drive project using DriveControlSuite.

Information

The program interface of DriveControlSuite is available in German, English and French. To change the language of the program interface, select **Settings > Language**.

Information

The DriveControlSuite help in the menu bar can be reached via **Help > Help for DS6** or via the [F1] key on your keyboard. When you press [F1] in an area of the program, the corresponding help topic opens.

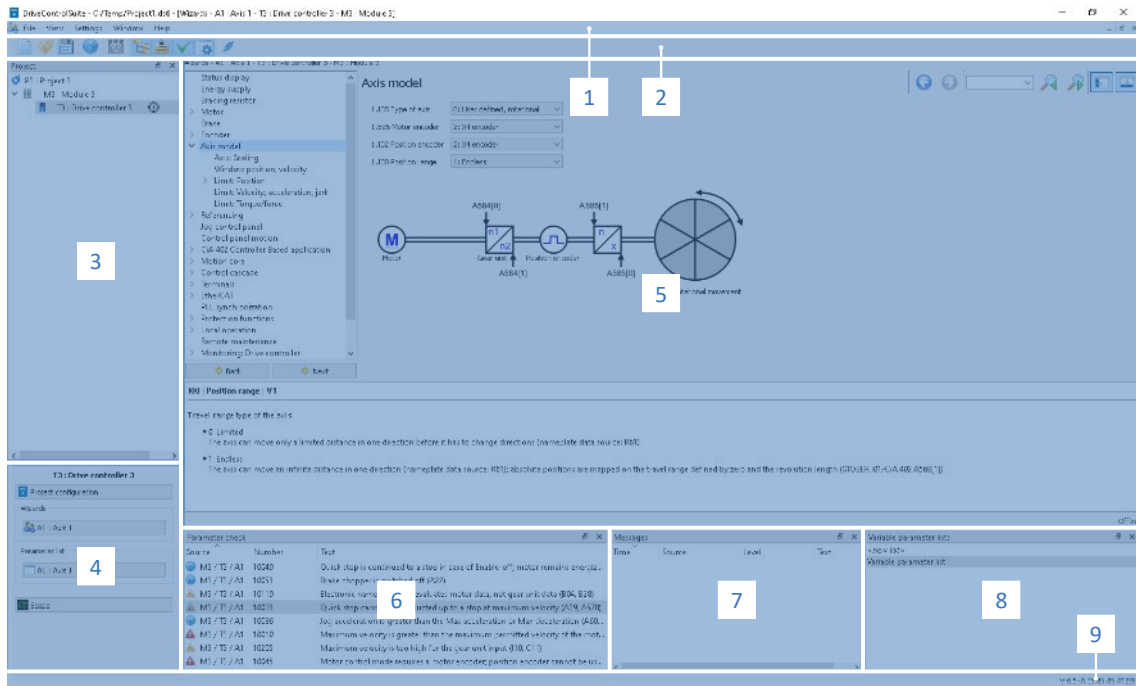

Fig. 2: DS6: Program interface





No.	Area	Description
1	Menu bar	Using the File, View, Settings and Window menus, you can open and save projects, display and hide program windows, select the interface language and access level and change between different windows in the workspace.
2	Toolbar	The toolbar enables quick access to frequently needed functions, like opening and saving projects and hiding and displaying windows in the program interface.
3	Project tree	The project tree forms the structure of your drive project in the form of modules and drive controllers. Select an element using the project tree first in order to edit it using the project menu.
4	Project menu	The project menu offers you various functions for editing the project, module and drive controller. The project menu adapts to the element that you selected in the project tree.
5	Workspace	The different windows which can be used to edit your drive project, such as the configuration dialog, wizards, the parameter list or the scope analysis tool, open in the workspace.
6	Parameter check	The parameter check points out irregularities and inconsistencies that were detected in the plausibility check of calculable parameters.
7	Messages	The entries in the messages log the connection and communication status of the drive controllers, incorrect inputs caught by the system, errors when opening a project or rule violations in the graphical programming.
8	Variable parameter lists	You can use variable parameter lists to compile any parameters in individual parameter lists for a quick overview.
9	Status bar	In the status bar, you can find the specifications of the software version and get additional information about the project file, the devices and the progress of the process during processes such as loading projects.

7.1.1.1 Configuring the view

In DriveControlSuite, you can change the visibility and arrangement of areas and windows, such as to optimize the available space in the workspace when working with smaller screens.

Showing/hiding areas

Use the icons in the toolbar or the items in the View menu to show or hide specific areas in DriveControlSuite as needed.

Icon	Item	Description
–	Reset	Resets the view to factory settings.
	Project	Shows/hides the Project window (project tree, project menu).
	Messages	Shows/hides the Messages window.
	Parameter check	Shows/hides the Parameter check window.
	Variable parameter lists	Shows/hides the Variable parameter lists window.

Arrange and group areas

You can undock and rearrange the individual areas via drag and drop. If you drag an undocked window to the edge of DriveControlSuite, you can release it there in a color-highlighted area either next to or on top of another window to redock it.

When you release the window onto another window, the two areas are merged into one window where you can use tabs to switch between the areas.

7.1.1.2 Navigation using sensitive circuit diagrams

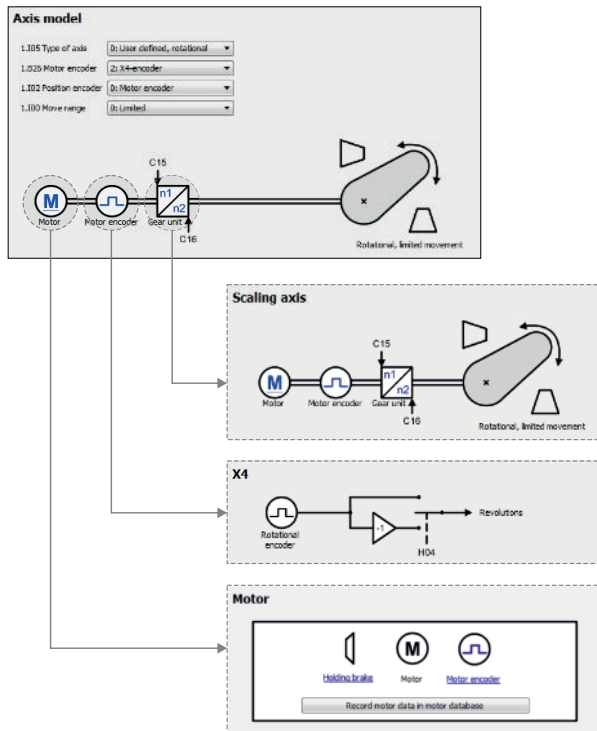

Fig. 3: DriveControlSuite: Navigation using text links and symbols

In order to illustrate graphically the processing sequence of actual and set values, the use of signals or certain drive component arrangements and to make configuring the accompanying parameters easier, they are displayed on the respective wizard pages of the workspace in the form of circuit diagrams.

Blue text links or clickable icons indicate links within the program. These refer to the corresponding wizard pages and, as a result, allow you to reach additional helpful detail pages with just a click.

7.1.2 TIA Portal program interface

The Siemens Totally Integrated Automation Portal (TIA Portal) offers a platform you can use to commission your PROFINET system. The TIA Portal is broken down into the portal view and the project view.

TIA portal view

The TIA overall functionality is broken down into different task areas that you can reach using portals. The following graphic shows the interface elements of the TIA portal view relevant to this documentation.

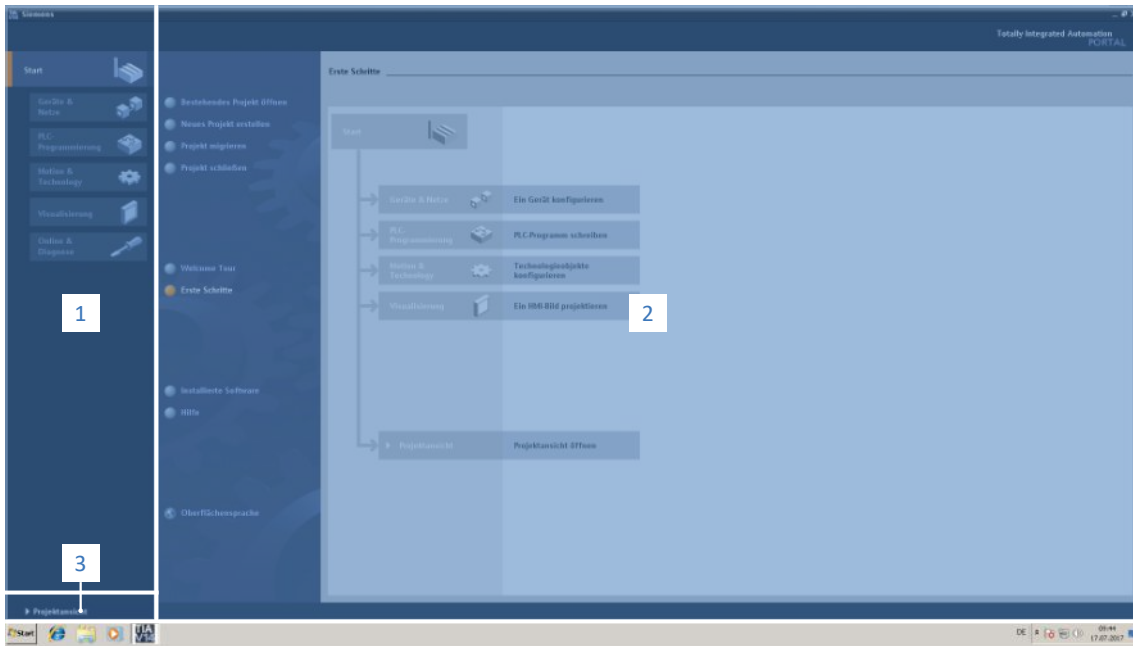

Fig. 4: TIA Portal: Program interface of the portal view

No.	Area	Description
1	Portal selection	The portal selection offers you access to various portals for different tasks and functions.
2	Portal functions	Depending on the selected portal, the portal functions are available here.
3	Project view	The button lets you change to the project view.

TIA project view

The TIA project view offers you access to all components of a project. The following graphic shows the interface elements of the TIA portal view relevant to this documentation.

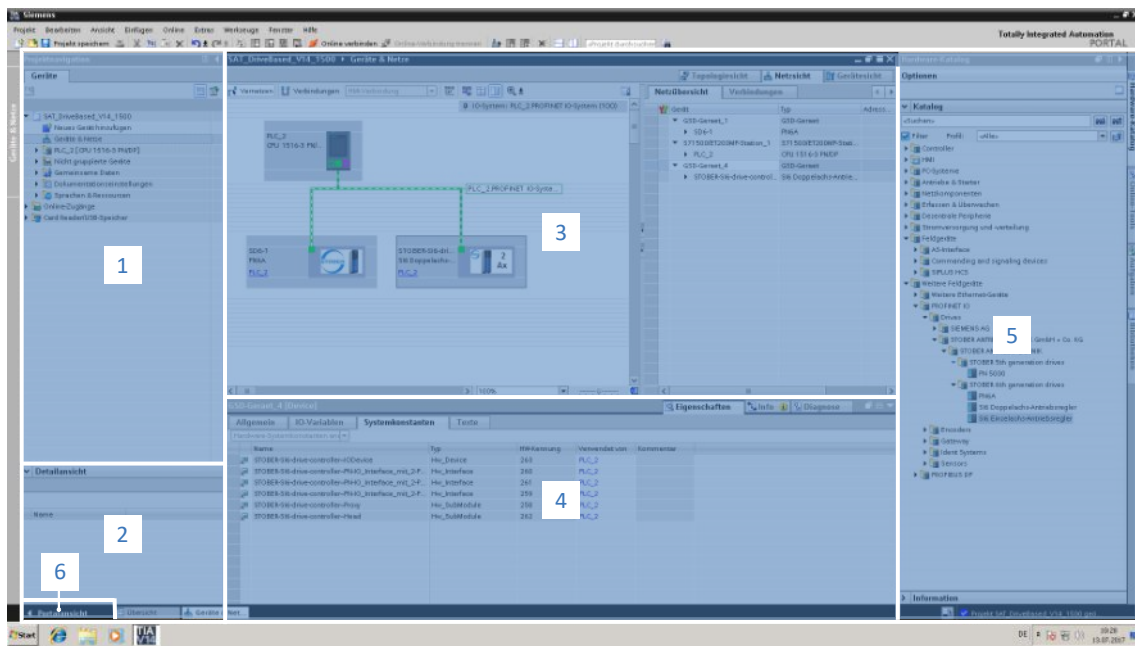

Fig. 5: TIA Portal: Program interface of the project view

No.	Area	Description
1	Project navigation	Project navigation offers you access to all components of your TIA project.
2	Details view	The details view shows you additional information about a selected object.
3	Workspace	In the workspace, you can edit objects in the topology view, network view or device view, for example.
4	Inspector window	The inspector window shows you additional information about a selected object.
5	Task cards	Task cards are available depending on the selected object and grant you access to the hardware catalog, online tools, tasks or libraries, for example.
6	Portal view	The button lets you change to the portal view.

7.2 Meaning of parameters

You can use parameters to adapt the function of the drive controller to your individual application. In addition, parameters visualize the current actual values (actual velocity, actual torque, etc.) and trigger actions such as Save values, Test phase, etc.

Interpretation of parameter identification

Parameter identification consists of the following elements, where short forms are also possible, i.e. only specifying a coordinate or the combination of coordinate and name.

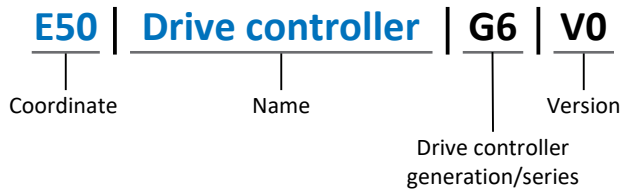

7.2.1 Parameter groups

Parameters are assigned to individual groups by topic. The 6th generation of STOBER drive controllers differentiates between the following parameter groups.

Group	Topic
A	Drive controllers, communication, cycle times
B	Motor
C	Machine, velocity, torque/force, comparators
D	Set value
E	Display
F	Terminals, analog and digital inputs and outputs, brake
G	Technology – Part 1 (application-dependent)
H	Encoder
I	Motion (all motion settings)
J	Motion blocks
K	Control panel
L	Technology – Part 2 (application-dependent)
M	Profiles (application-dependent)
N	Additional functions (application-dependent; e.g. extended cam control unit)
P	Customer-specific parameters (programming)
Q	Customer-specific parameters, instance-dependent (programming)
R	Production data for the drive controller, motor, brakes, motor adapter, gear unit and geared motor
S	Safety (safety technology)
T	Scope
U	Protection functions
Z	Fault counter

Tab. 3: Parameter groups

7.2.2 Parameter types and data types

In addition to topic-based sorting in individual groups, all parameters belong to a certain data type and parameter type. The data type of a parameter is displayed in the parameter list, properties table. The connections between parameter types, data types and their value range can be found in the following table.

Data type	Parameter type	Length	Value range (decimal)
INT8	Integer or selection	1 byte (signed)	-128 – 127
INT16	Integer	2 bytes (1 word, signed)	-32768 – 32767
INT32	Integer or position	4 bytes (1 double word, signed)	-2147483648 – 2147483647
BOOL	Binary number	1 bit (internal: LSB in 1 byte)	0, 1
BYTE	Binary number	1 byte (unsigned)	0 – 255
WORD	Binary number	2 bytes (1 word, unsigned)	0 – 65535
DWORD	Binary number or parameter address	4 bytes (1 double word, unsigned)	0 – 4294967295
REAL32 (single type according to IEE754)	Floating-point number	4 bytes (1 double word, signed)	$-3.40282 \times 10^{38} - 3.40282 \times 10^{38}$
STR8	Text	8 characters	—
STR16	Text	16 characters	—
STR80	Text	80 characters	—

Tab. 4: Parameters: data types, parameter types, possible values

Parameter types: Use

- Integer, floating-point number
For general computing processes
Example: Set and actual values
- Selection
Numeric value to which a direct meaning is assigned
Example: Sources for signals or set values
- Binary number
Bit-oriented parameter information that is collected in binary
Example: Control and status words
- Position
Integer combined with associated units and decimal places
Example: Actual and set values of positions
- Velocity, acceleration, deceleration, jerk
Floating-point number combined with associated units
Example: Actual and set values for velocity, acceleration, deceleration, jerk
- Parameter address
Referencing of a parameter
Example: In F40 AO1 source, for example, E08 n-motor filtered can be parameterized
- Text
Outputs or messages

7.2.3 Parameter types

The following types of parameters are differentiated.

Parameter type	Description	Example
Simple parameters	Consist of one group and one line with a defined value.	A21 Brake resistor R: Value = 100 ohms
Array parameters	Consist of a group, a line and multiple sequential (listed) elements, which have the same properties but different values.	A10 Access level <ul style="list-style-type: none"> A10[0] access level: Value = Access level via operating unit A10[2] access level: Value = Access level via CANopen and EtherCAT A10[4] access level: Value = Access level via PROFINET
Record parameters	Consist of a group, a line and multiple sequential (listed) elements, which can have different properties and different values.	A00 Save values <ul style="list-style-type: none"> A00[0] Start: Value = Start action A00[1] Progress: Value = Display action progress A00[2] Result: Value = Display action result

Tab. 5: Parameter types

7.2.4 Parameter structure

Every parameter has specific coordinates with the following structure.

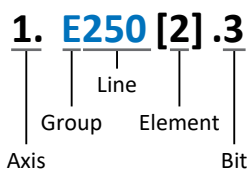

- **Axis (optional)**
In case of multiple axes, the one to which a parameter is assigned; not applicable for global parameters (value range: 1 – 4).
- **Group**
The thematic group to which a parameter belongs (value range: A – Z).
- **Line**
Distinguishes the parameters within a parameter group (value range: 0 – 999).
- **Element (optional)**
Elements of an array or record parameter (value range: 0 – 16000).
- **Bit (optional)**
Selection of a single bit for complete data addressing; depends on the data type (value range: 0 – 31).

7.2.5 Parameter visibility

The visibility of a parameter is primarily controlled by the access level you set in DriveControlSuite and by the properties you project for the respective drive controller (e.g. hardware, firmware and application). A parameter can also be shown or hidden depending on other parameters or settings. For example, the parameters of an additional function are only shown as soon as you activate the relevant additional function.

Access level

The access options for the individual software parameters are ranked hierarchically and divided into individual levels. This means that parameters can be hidden for a specific purpose and, relatedly, their configuration options can be locked starting from a specific level.

Each parameter has one access level for read access (visibility) and one access level for write access (editability). The following levels are present:

- Level 0
Elementary parameters
- Level 1
Important parameters of an application
- Level 2
Important parameters for service with extensive diagnostic options
- Level 3
All parameters needed for commissioning and optimizing an application

The parameter A10 Access level controls general access to parameters:

- Over CANopen or EtherCAT (A10[2])
- Over PROFINET (A10[3])

Information

It is not possible to write to or read the parameter hidden in DriveControlSuite during communication via fieldbus.

Hardware

Which parameters are available to you in DriveControlSuite is determined by which series you select in the configuration dialog for the drive controller, for example, or whether you project an option module. Basically, the only parameters that are displayed are the ones you need to parameterize the configured hardware.

Firmware

Due to the further development and updating of functions for the 6th generation of STOBER drive controllers, new parameters and also new versions of existing parameters are continuously being implemented in DriveControlSuite and in the firmware. The parameters are displayed in the software according to the DriveControlSuite version used and the configured firmware version of the respective drive controller.

Applications

Applications generally differ in terms of functions and their control. For this reason, different parameters are available with each application.

7.3 Signal sources and process data mapping

The transmission of control signals and set values in DriveControlSuite meets the following principles.

Signal sources

Drive controllers are controlled either over a fieldbus, using mixed operation consisting of a fieldbus system and terminals or exclusively using terminals.

You can use the corresponding selection parameters, referred to as signal sources, to configure whether the control signals and set values of the application are obtained over a fieldbus or using terminals.

In case of activation over a fieldbus, parameters that are selected as data sources for control signals or set values must be part of the subsequent process data mapping. In the case of activation using terminals, the respective analog or digital inputs are specified directly.

Process data mapping

If you are working with a fieldbus system and have selected the source parameters for control signals and set values, configure the fieldbus-specific settings, e.g. the assignment of the process data channels for transmitting receive and transmit process data, as the last step. The respective procedure can be found in the accompanying STOBER fieldbus manuals.

7.4 Non-volatile memory

All project configurations, parameterizations and related changes to parameter values are in effect after transmission to the drive controller, but are only stored in volatile memory.

Saving to a drive controller

To save the configuration in non-volatile memory on a drive controller, you have the following options:

- Saving the configuration using the *Save values wizard*:
Project menu > Wizards area > Projected axis > Save values wizard: Select the Save values action
- Saving the configuration using the parameter list:
Project menu > Parameter list area > Projected axis > Group A: Drive controller > A00 Save values: Set the parameter A00[0] to the value 1: Active

Saving to all drive controllers within a project

To save the configuration in non-volatile memory on several drive controllers, you have the following options:

- Saving the configuration using the toolbar:
Toolbar > Save values icon: Click the Save values icon
- Saving the configuration using the Online functions window:
Project menu > Online connection button > Online functions window: Click on Save values (A00)

Information

Do not shut off the drive controller while saving. If the supply voltage to the control unit is interrupted while saving, the drive controller will start without an executable configuration the next time it is switched on. In this case, the configuration must be transferred to the drive controller again and stored in non-volatile memory.

8 Commissioning

The following chapters describe the commissioning of your drive controller with integrated SU6 safety module using STOBER DriveControlSuite in combination with TIA Portal and SIMATIC STEP 7 Safety from Siemens AG.

We put forward the following system environment as an example so that you can follow the individual commissioning steps exactly:

- STOBER drive controller of the SC6 or SI6 series in firmware version V 6.5-D-PN or later with integrated SU6 safety module
- STOBER DriveControlSuite commissioning software in version 6.5-D or later

in combination with

- Siemens controller SIMATIC S7-1500F with Safety Integrated
- Siemens Totally Integrated Automation Portal (TIA Portal) V16 automation software
- Siemens SIMATIC STEP 7 Safety Basic / Advanced options package for TIA Portal V16

Commissioning is divided into the following steps:

1. SU6 safety module
Enter a valid PROFIsafe destination address using a DIP switch.
2. Observe the time setting recommendations for the following configuration.
3. DriveControlSuite
Configure all drive controllers including the safety module, device control system, process data for fieldbus communication and axes of your drive system in DriveControlSuite. Then, transmit your configuration to the drive controllers of the system network.
4. TIA Portal:
Select the correct GSD file for your application. Next, map your entire hardware environment and configure it. Then, activate your system and check the PROFIsafe communication of the nodes.
5. Then, check the safety functions and document the results in a test report.

Information

Before you start commissioning your PROFINET network using DriveControlSuite and TIA Portal, you must network all nodes of your PROFINET network with each other.

Information

Always perform the steps described below in the specified order!

Some parameters are interdependent and do not become accessible to you until you have first configured certain settings. Follow the steps in the specified sequence so that you can finish the parameterization completely.

8.1 SU6: Assign the PROFIsafe destination address

In order to be able to identify the SU6 safety module in the PROFIsafe network, you must assign it a unique address in the PROFIsafe network. The address is based on values from the DIP switches on the top of the drive controller that are switched to ON (for detailed information, see the chapter [SU6: Assign the PROFIsafe destination address \[▶ 63\]](#)).

Information

The drive controller must be switched off before you assign the address for the SU6 safety module using S12 DIP switches. The drive controller has to be restarted to apply the address.

8.2 Recommended time settings

In the event of a quick stop with a subsequent STO (stop category 1 in accordance with DIN EN 60204-1 or Safe Stop 1 (SS1-t) in accordance with DIN EN 61800-5-2) or in the event of a controlled axis stop, the communication is interrupted and the power unit may be deactivated prematurely. In this case, axis movement can no longer be controlled by the drive controller.

In order to prevent premature deactivation of the power unit, you must take the delay time for the quick stop (quick stop time) into account when parameterizing the SS1 delay time and watchdog time.

Quick stop time

The quick stop time is a result of the application-specific quick stop deceleration and maximum velocity. Parameterize the maximum velocity in I10 Maximal speed. In Drive Based or PROFIdrive applications, parameterize the quick stop deceleration in I17 Quickstop deceleration.

SS1 delay time

In TIA Portal, set a larger value for SS1 Delay Time in the device configuration of the safety module than for the resulting quick stop time. The reserve should generally be 10% and should not fall below 50 ms. You can check the SS1 delay time in S47 PROFIsafe SS1-time.

PROFIsafe watchdog time

In TIA Portal, set a larger value for the F_WD_Time watchdog time in the device configuration of the safety module than for the resulting quick stop time plus the PZD timeout (A109 PZD-Timeout). The reserve should generally be 10% and should not fall below 100 ms. You can check the watchdog time in S46 PROFIsafe watch dog time. More information on the watchdog time can be found in the chapter [Watchdog time \[▶ 64\]](#).

8.3 DS6: Configuring the drive controller

Project and configure all drive controllers for your drive system using DriveControlSuite.

8.3.1 Initiating the project

In order to be able to configure all drive controllers and axes of your drive system using DriveControlSuite, you must record them as part of a project.

8.3.1.1 Projecting the drive controller and axis

Create a new project and project the first drive controller along with the accompanying axis.

Creating a new project

1. Start DriveControlSuite.
2. On the start screen, click **Create new project**.
 - ⇒ The new project is created and the configuration dialog for the first drive controller opens.
 - ⇒ The **Drive controller** button is active.

Projecting the drive controller

1. **Properties tab:**
 Establish the relationship between your circuit diagram and the drive controller to be projected in DriveControlSuite.
 Reference: Specify the reference code (equipment code) of the drive controller.
 Designation: Give the drive controller a unique name.
 Version: Version your project configuration.
 Description: If necessary, specify additional supporting information, such as the change history of the project configuration.
2. **Drive controller tab:**
 Select the series and device type of the drive controller.
 Firmware: Select the PROFINET version 6.x -**PN**.
3. **Option modules tab:**
 Safety module: Select the SU6 module.
4. **Device control tab:**
 Device control: Select PROFIdrive or Drive Based device control according to your application.
 Rx process data, Tx process data: Select PROFINET Rx and PROFINET Tx for transmitting PROFINET process data.

Information

Make sure that you project the correct series in the **Drive controller** tab. The projected series cannot be changed afterwards.

Information

You can use the SU6 safety module with both Drive Based device control and PROFIdrive device control and the corresponding applications.

Projecting the axis

1. Click on Axis 1.
2. **Properties tab:**
Establish the connection between your circuit diagram and the axis to be projected in DriveControlSuite.
Reference: Specify the reference code (equipment code) of the axis.
Designation: Give the axis a unique name.
Version: Version your project configuration.
Description: If necessary, specify additional supporting information, such as the change history of the project configuration.
3. **Application tab:**
Select the desired application according to the projected device control.
4. **Motor tab:**
Select the type of motor operated using this axis. If you are working with motors from third-party suppliers, enter the accompanying motor data at a later time.
5. Repeat steps 2 – 4 for the 2nd axis (only for double-axis controllers).
6. Confirm with OK.

8.3.2 Parameterizing general PROFINET settings

- ✓ You have projected the PROFINET Rx and PROFINET Tx process data for the drive controller.
1. Select the relevant drive controller in the project tree and click on the first projected axis in the Project menu > Wizard area.
 2. Select the PROFINET wizard.
 3. **A100 Fieldbus scaling:**
Leave the default value at 1: Native (values are passed unchanged).
 4. **A273 PN device name:**
Elements [0] to [2] show the PROFINET device name that was assigned in TIA Portal if there is an online connection between the drive controller and controller.
In elements [3] to [5], you have the option to enter the device name. This eliminates the need to assign the device name in TIA Portal.
 5. **A109 PZD-Timeout:**
Define the time that results from the tolerated failure time for monitoring the PZD communication plus the watchdog time of the controller (TIA Portal: watchdog time) in the PROFINET network (default value: 20 ms).

8.3.3 Calculating checksum F_iPar_CRC

Use DriveControlSuite to calculate checksum F_iPar_CRC for PROFIsafe communication, which you need for the device configuration of the SU6 safety module in TIA Portal.

- ✓ You have projected the SU6 safety module for the drive controller in question.
 - 1. Select the relevant drive controller in the project tree and click on the first projected axis in the project menu > Wizard area.
 - 2. Select the PROFINET wizard > Calculate F_iPar-CRC: PROFIsafe.
 - 3. SS1 Delay Time:
Enter the SS1 delay time as a multiple of 10 ms.
 - 4. Click on Calculate.
- ⇒ Checksum F_iPar_CRC is calculated.

Information

Enter the SS1 delay time as a multiple of 10 ms. An SS1 Delay Time of 100 corresponds to 1 s ($100 \times 10 \text{ ms} = 1 \text{ s}$).

Assign a larger value for SS1 Delay Time than for the quick stop time of the drive controller. The reserve should generally be 10% and should not fall below 50 ms.

Information

You need checksum F_iPar_CRC for PROFIsafe communication. Calculate the checksum using the SS1 delay time in DriveControlSuite and transmit F_iPar_CRC to the parameter of the same name in TIA Portal when configuring the safety module.

If you make changes to the SS1 delay time, you must also recalculate F_iPar_CRC and store it in the device configuration of the safety module in TIA Portal.

8.3.4 Transmitting and saving the configuration

In order to transmit and save the configuration to one or more drive controllers, you must connect your PC and the drive controllers over the network.

WARNING!

Injury to persons and material damage due to axis movement!

If there is an online connection between DriveControlSuite and the drive controller, changes to the configuration can lead to unexpected axis movements.

- Only change the configuration if you have visual contact with the axis.
- Make sure that no people or objects are within the travel range.
- For access via remote maintenance, there must be a communication link between you and a person on site with eye contact to the axis.

Information

During the search, all drive controllers within the broadcast domain are found via IPv4 limited broadcast.

Requirements for finding a drive controller in the network:

- Network supports IPv4 limited broadcast
- All drive controllers and the PC are in the same subnet (broadcast domain)

Transmitting the configuration

- ✓ The drive controllers are switched on.
1. In the project tree, select the module under which you have recorded your drive controller and click **Online connection** in the project menu.
 - ⇒ The **Add connection** dialog box opens. All drive controllers found via IPv4 limited broadcast are displayed.
 2. **Direct connection tab > IP address column:**
 Activate the IP addresses in question and confirm your selection with **OK**.
 - ⇒ The **Online functions** window opens. All drive controllers connected through the selected IP addresses are displayed.
 3. Select the drive controller to which you would like to transfer the configuration. Change the selection of transmission type from **Read** to **Send**.
 4. Change the selection **Create new drive controller:**
 Select the configuration that you would like to transfer to the drive controller.
 5. Repeat steps 3 and 4 for all other drive controllers to which you would like to transfer your configuration.
 6. **Online tab:**
 Click **Establish online connections**.
 - ⇒ The configuration is transferred to the drive controllers.

Saving a configuration

- ✓ You have successfully transmitted the configuration.
- 1. Online functions window:
Click Save values (A00).
 - ⇒ The Save values (A00) window opens.
- 2. Click Start action.
 - ⇒ The configuration is stored on the drive controllers in non-volatile memory.
- 3. Close the Save values (A00) window.

Information

For the configuration to take effect on the drive controller, a restart is required when the configuration is saved on the drive controller for the first time or when changes are made to the firmware or process data mapping.

Restarting a drive controller

- ✓ You have stored the configuration on the drive controller in non-volatile memory.
- 1. Online functions window:
Click Restart (A09).
 - ⇒ The Restart (A09) window opens.
- 2. Select which of the connected drive controllers you want to restart.
- 3. Click Start action.
- 4. Confirm the safety instruction with OK.
 - ⇒ The Restart (A09) window closes.
- ⇒ The fieldbus communication and connection between DriveControlSuite and drive controllers are interrupted.
- ⇒ The selected drive controllers restart.

8.4 TIA Portal: Configuring the safety technology

Project and configure the PROFIsafe-capable controller (F-host) and all PROFIsafe-capable drive controllers (F-devices) of your drive system. To do so, install the required GSD file and map the PROFIsafe-capable devices of your PROFINET network in a TIA project.

Then, configure the controller. Adjust the general PROFINET settings and configure the PROFIsafe settings of the F-CPU.

In the next step, configure the drive controller. Adjust the general PROFINET settings, project the SU6 safety module and configure its PROFIsafe settings.

Then, transfer the configuration to the controller and check the PROFIsafe communication. Then, check the safety functions and document the results in a test report.

8.4.1 Installing the GSD file

To be able to map the STOBER drive controllers of your PROFINET network in your TIA project, you must import and install a GSD file (general station description file) from STOBER in your TIA project. STOBER drive controllers are available in the hardware catalog of your TIA project as soon as the GSD file has been installed.

Information

If you have already downloaded a GSD file from the STOBER download area at an earlier point, make sure that you are using the current version of the GSD file required.

- ✓ You have downloaded the current version of the GSD file from the STOBER download area and saved it locally.
- ✓ You have created a TIA project and are in the TIA project view.
- 1. In the menu bar, select **Options > Manage general station description files (GSD)**.
 - ⇒ The **Manage general station description files window** opens.
- 2. **Installed GSDs tab > Source path area:**
Select the directory in which you have stored the GSD file from STOBER and confirm with **OK**.
 - ⇒ The GSD file is displayed in the **Content of the imported path area**.
- 3. **Content of the imported path area:**
Select the desired GSD file and click on **Install**.
 - ⇒ The GSD file is installed; the STOBER drive controllers are available in the hardware catalog.

8.4.2 Projecting the PROFINET network

Map the controller and all drive controllers of your PROFINET network in a TIA project by selecting the corresponding modules from the hardware catalog and incorporating them into the project.

8.4.2.1 Projecting the controller

Project the controller of your PROFINET network.

- ✓ You have created a TIA project and installed the GSD file from STOBER.
 - ✓ You are in the TIA network view; the hardware catalog is open.
1. Hardware catalog:
Select **Controller > SIMATIC S7-1500 > CPU** and open the folder of the CPU type that belongs to your controller.
 2. Drag and drop the desired controller into the network view.
- ⇒ The controller is incorporated into your TIA project.

Information

If you would like to use PROFIsafe, you must project a failsafe CPU (F-CPU). You can identify an F-CPU in the hardware catalog by the yellow symbol and letter F in the device name (e.g. CPU 1215FC).

8.4.2.2 Projecting the drive controller

Project all drive controllers of your PROFINET network.

- ✓ You have created a TIA project and installed the GSD file from STOBER.
- ✓ You are in the TIA network view; the hardware catalog is open.
- 1. Hardware catalog:
Select Other field devices > PROFINET IO > Drives > STOBER ANTRIEBSTECHNIK GmbH & Co. KG > STOBER ANTRIEBSTECHNIK > STOBER 6th generation drive controllers > SI6, SC6 double-axis controllers/SI6, SC6 single-axis controllers.
- 2. Drag and drop the desired drive controller into the network view.
⇒ The drive controller is incorporated into your TIA project.
- 3. Repeat steps 1 and 2 for all drive controllers of your PROFINET network.

Information

To be able to project the SU6 safety module and use PROFIsafe, you must project a PROFIsafe-capable drive controller. You can identify a PROFIsafe-capable drive controller in the hardware catalog by the addition of **+ PROFIsafe** or **+ PS** in the device name.

8.4.2.3 Linking the controller and drive controller logically

Establish a logical gate link between the controller and drive controllers in order to enable the communication between the devices.

- ✓ You have projected the controller and drive controllers.
- ✓ You are in the TIA network view.
- 1. Click on the interface of the controller and drag a connection to the interface of the first drive controller while holding the mouse button.
- 2. Repeat the process for all drive controllers of your PROFINET network.
⇒ The controller and drive controllers of your PROFINET network are linked logically with each other.

Information

To be able to link the controller and drive controllers with each other logically, you must be in the TIA network view.

8.4.3 Configuring the controller

Configure the network addresses for the controller as needed.

Then, configure the safety-related settings. Make sure that the F-capability of the controller is activated, check the PROFIsafe source address and configure the F-runtime group.

8.4.3.1 Configuring network addresses

As needed, you can change the IP address and subnet mask of the controller.

- ✓ You are in the TIA network view.
- 1. Double-click on the controller of your PROFINET network.
 - ⇒ This switches you to the respective device view; the Inspector window shows the device properties.
- 2. Inspector window > General tab:
Select PROFINET interface > Ethernet addresses in the area navigation.
- 3. IP protocol area > Set IP address in the project:
If not set by default, activate this option and change the IP address and subnet mask of the controller.
 - ⇒ The IP address and subnet mask of the controller are configured.

8.4.3.2 Configuring the PROFIsafe source address

Make sure that F-capability is activated for the controller (F-CPU) and check the PROFIsafe source address.

- ✓ You have projected an F-CPU for your TIA project.
- ✓ You are in the TIA network view.
- 1. Double-click on the controller of your PROFINET network.
 - ⇒ This switches you to the respective device view; the inspector window shows the device properties.
- 2. Inspector window > General tab:
Select Fail-safety in the area navigation.
 - ⇒ The settings for fail-safety open.
- 3. F-activation area:
Make sure that the F-capability is activated.
- 4. F-parameter area > Upper limit for F destination address:
Define the value 254 as an upper limit for the PROFIsafe destination address.
- 5. F-parameter area > Central F-source address:
Make sure that a PROFIsafe source address is stored for the controller (default value: 1).

Information

In TIA Portal, make sure that the PROFIsafe source addresses of the F-CPU match in the device configuration of the controller and in the device configuration of the drive controller (controller: Central F-source address; drive controller: F_Source_Add).

8.4.3.3 Configuring the F-runtime group

The F-runtime group is responsible for managing and running the safety program and consists of at least three F-blocks: the main safety block (F-FB), which contains the actual safety program; the associated failsafe data block (F-DB); and the failsafe organization block (F-OB), which calls up the main safety block cyclically. For the F-OB, configure the cycle time and priority with which the main safety block is to be called up and define the cycle times for the monitoring of the F-runtime group by the F-CPU of the controller.

Information

If you add an F-CPU to your project, STEP 7 Safety creates the F-blocks that you need for an F-runtime group by default and adds them to the F-runtime group automatically.

- ✓ You have projected a controller with an F-CPU for your TIA project.
 - ✓ You are in the TIA network view.
1. Project navigation > Devices tab:
Open the Safety Administration Editor of the controller in question by double-clicking on Safety administration.
⇒ The Safety Administration Editor opens.
 2. Safety Administration Editor:
Select F-runtime group in the area navigation.
⇒ The settings for F-runtime group 1 open.
 3. Failsafe organization block area:
Parameterize the F-OB.
 - 3.1. Event class:
Make sure that Cyclic interrupt is set as the event class for the F-OB to ensure that the main safety block is called up in fixed intervals.
 - 3.2. Cycle time:
Define a cycle time for the F-OB which is smaller than parameter Cycle time warning limit of the F-runtime group.
 - 3.3. Priority:
Define a priority for the F-OB that is higher, if possible, than the priorities of the other organization blocks.
 4. Parameters of F-runtime group area:
Parameterize the maximum cycle times for the monitoring of the F-runtime group by the controller.
 - 4.1. Cycle time warning limit of the F-runtime group:
Define the maximum time that may pass between 2 calls of the F-runtime group before an entry is written in the diagnostics buffer of the controller.
 - 4.2. Maximum cycle time of the F-runtime group:
Define the maximum time that may pass between 2 calls of the F-runtime group before the controller enters the STOP operating state.

8.4.4 Configuring the drive controller

Assign a device name for the drive controllers of your TIA project to be able to identify them in the PROFINET network. Then, project the process data modules and configure the settings for PZD transmission between the controller and drive controller.

Then, project the SU6 safety module and configure the PROFIsafe addresses and the times for the SS1 delay and PROFIsafe watchdog for it. Then, assign meaningful names for the two lowest-value bits of the PROFIsafe control word and PROFIsafe status word.

8.4.4.1 Assigning device names

Assign a device name for your drive controllers to be able to identify them in the PROFINET network.

✓ You are in the TIA network view.

1. Double-click on a drive controller of your PROFINET network.
 - ⇒ This switches you to the respective device view; the Inspector window shows the device properties.
2. Inspector window > General tab:
 - Select **General** in the area navigation.
3. Name:
 - Assign a device name for the drive controller that corresponds to the PROFINET naming conventions.
4. Device view:
 - Select the relevant drive controller and select **Assign device name** using its context menu.
 - ⇒ The **Assign PROFINET device name** window opens.
5. Click on **Update list**.
 - ⇒ All drive controllers are listed that were found in the subnet.
 - ⇒ Depending on the drive controller, the device type, IP address and MAC address are displayed.
6. Mark the drive controller that you would like to name and click on **Assign name**.
 - ⇒ The device name is assigned to the selected drive controller.

Information

Alternatively, you can enter the device name in DriveControlSuite in parameter A273[3] to [5]. This eliminates steps 4 to 6 in TIA Portal for assigning the device name.

Information

Using **Flash LED**, you can identify which drive controller you have currently selected if multiple drive controllers are found in the same subnet.

As an alternative, you can identify the drive controller by its MAC address. The MAC address of the drive controller can be read off in parameter A279 PN MAC addresses in DriveControlSuite (**PROFINET wizard > Diagnostics**).

8.4.4.2 Projecting the process data module

Define the data volume for the PZD transmission of the PROFINET communication by projecting a process data module for each axis.

- ✓ You are in the TIA network view; the hardware catalog is open.
- 1. Double-click on a drive controller of your PROFINET network.
 - ⇒ This switches you to the respective device view; the inspector window shows the device properties.
- 2. Hardware catalog:
 - Select **Module > Cat 1: Process data modules (PZD), all consistent**.
- 3. Select a process data module with a data volume that corresponds at least to your process data map in the drive controller.
- 4. Drag and drop the selected module into the device overview of the drive controller at slot 1 provided for this.
- 5. If you are using a double-axis controller, repeat the process for the second axis and slot 2.
 - ⇒ The input and output addresses of the drive controller are generated automatically.

Information

For the project configuration of the SU6 safety module, proceed as described in [Configuring PROFIsafe settings \[▶ 42\]](#).

8.4.4.3 Configuring PZD transmission

For the PZD transmission, configure the cycle time for the data exchange as well as the watchdog time for the monitoring of PROFINET communication between the controller and drive controller.

✓ You are in the TIA network view.

1. Double-click on a drive controller of your PROFINET network.

⇒ This switches you to the respective device view; the inspector window shows the device properties.

2. Inspector window:

In the area navigation, select PROFINET interface [X1] > Advanced options > Real-time settings > IO cycle.

3. Update time:

Configure the cycle time in which the controller and drive controller exchange data.

3.1. Calculate update time automatically:

If the cycle time is to be calculated automatically, select this option.

3.2. Set update time manually:

If you want to set the cycle time manually, select this option and specify the desired time.

3.3. Adapt update time when send clock changes:

If you have set the cycle time manually and if the ratio between cycle time and transmission cycle is to remain constant, also select this option.

4. Watchdog time area:

Configure the watchdog time for monitoring the PROFINET communication.

4.1. Accepted update cycles without IO data:

Enter the number of permitted cycles after which the PROFINET watchdog is triggered in case of an interruption in PROFINET communication.

4.2. Watchdog time:

The watchdog time for PROFINET communication is calculated automatically based on the cycle time and the permitted cycles without data exchange and must not exceed 1.92 seconds.

Information

The application-dependent cycle time of the drive controller can be read off in parameter A150 Cycle time in DriveControlSuite.

8.4.4.4 Configuring PROFIsafe settings

After you complete configuration of the basic PROFINET settings, continue with the configuration of the PROFIsafe settings. Project and configure the SU6 safety module, specify the SS1 delay time and assign a meaningful name for the relevant bit of the PROFIsafe control word and PROFIsafe status word.

8.4.4.4.1 Projecting the SU6 safety module

Project the SU6 safety module for the drive controller in order to then be able to configure the safety-related settings.

- ✓ You are in the TIA network view; the hardware catalog is open.
- 1. Double-click on the drive controller for which you want to project the SU6 safety module.
 - ⇒ This switches you to the respective device view.
- 2. Hardware catalog:
Select Module > Safety module (XP).
- 3. Drag and drop the Safety module (XP) safety module into the device overview of the drive controller at the bottom slot provided for this.
 - ⇒ The SU6 safety module is projected for the drive controller.

Information

For each drive controller, you can project only one safety module for the intended slot (single-axis controller: slot 2, double-axis controller: slot 3). Safety module (XP) supports the latest PROFIsafe version 2.61, while Safety module (LP, old) supports PROFIsafe version 2.4.

8.4.4.4.2 Configuring the PROFIsafe addresses

Configure the PROFIsafe destination address for the SU6 safety module and store the PROFIsafe source addresses of the controller.

- ✓ You are in the TIA device view of the drive controller.
 - 1. Select the safety module in the device overview of the drive controller.
 - ⇒ The inspector window shows the device properties of the safety module.
 - 2. General tab:
Select PROFIsafe in the area navigation.
 - 3. PROFIsafe area > F_Source_Add:
Enter the PROFIsafe address of the controller (Central F-source address).
 - 4. PROFIsafe area > F_Dest_Add:
Enter the PROFIsafe address of the safety module (S41 PROFIsafe address).
- ⇒ The PROFIsafe addresses for the SU6 safety module are configured.

Information

In TIA Portal, make sure that the PROFIsafe source addresses of the F-CPU match in the device configuration of the controller and in the device configuration of the drive controller (controller: Central F-source address; drive controller: F_Source_Add).

Information

The PROFIsafe destination address F_Dest_Add, which you set using the DIP switch on the drive controller and store in TIA Portal, can be read off in parameter S41 PROFIsafe address in DriveControlSuite (Monitoring: PROFIsafe wizard).

8.4.4.4.3 Configuring PROFIsafe communication

Enter the checksum for the monitoring of PROFIsafe communication that you have calculated in DriveControlSuite and define the watchdog time after which an STO is triggered in case of an interruption in PROFIsafe communication. Define the SS1 delay after which the drive controller is stopped when an SS1-t is triggered.

Configuring the PROFIsafe watchdog and checksum

- ✓ You are in the TIA device view of the drive controller.
 - ✓ The inspector window shows the device properties of the safety module.
1. **General tab:**
Select PROFIsafe in the area navigation.
 2. **PROFIsafe area > F_WD_Time:**
Enter the watchdog time after which an STO is triggered in case of an interruption in PROFIsafe communication.
 3. **PROFIsafe area > F_iPar_CRC:**
Enter the value for the checksum of the F_iPar parameter that you have calculated based on the SS1 delay time in DriveControlSuite.

Information

Assign a larger value for the PROFIsafe watchdog time F_WD_Time than for the quick stop time of the drive controller plus the PZD timeout (A109 PZD-Timeout). The reserve should generally be 10% and should not fall below 100 ms.

Information

You need checksum F_iPar_CRC for PROFIsafe communication. Calculate the checksum using the SS1 delay time in DriveControlSuite and transmit F_iPar_CRC to the parameter of the same name in TIA Portal when configuring the safety module.

If you make changes to the SS1 delay time, you must also recalculate F_iPar_CRC and store it in the device configuration of the safety module in TIA Portal.

Configuring SS1 delay time

Enter the delay after which the STO safety function is active when triggering an SS1-t.

- ✓ You are in the TIA device view of the drive controller.
 - ✓ The inspector window shows the properties of the safety module.
1. General tab:
Select **Module parameters** in the area navigation.
⇒ The settings for the module parameters open.
 2. Failsafe organization block area > SS1 Delay Time:
Enter the SS1 delay time as a multiple of 10 ms.

Information

Enter the SS1 delay time as a multiple of 10 ms. An SS1 Delay Time of 100 corresponds to 1 s (100 × 10 ms = 1 s).

Assign a larger value for SS1 Delay Time than for the quick stop time of the drive controller. The reserve should generally be 10% and should not fall below 50 ms.

Information

If you make changes to the SS1 delay time, you must also recalculate `F_iPar_CRC` with the changed value and store it in the device configuration of the safety module in TIA Portal.

8.4.4.4.4 Configuring PROFIsafe status word and PROFIsafe control word

You can make programming the safety program easier by assigning meaningful names for the relevant bits of the PROFIsafe status word and PROFIsafe control word.

- ✓ You are in the TIA device view of the drive controller.
- ✓ The inspector window shows the properties of the safety module.
- 1. Switch from the **General** tab to the **IO variables** tab.
 - ⇒ The inspector window shows you the control and status word for the safety functions.
- 2. Name column:
Assign a meaningful name for the two lowest-value bits of the status word (address %I).
 - 2.1. Assign a meaningful name for bit 0 of the status word that shows whether the STO safety function is active, e.g. `STO_IsActive`.
 - 2.2. Assign a meaningful name for bit 1 of the status word that shows whether the SS1 safety function is active, e.g. `SS1_IsActive`.
- 3. Name column:
Assign a meaningful name for the two lowest-value bits of the control word (address %I).
 - 3.1. Assign a meaningful name for bit 0 of the control word that requests the STO safety function, e.g. `STO_Request`.
 - 3.2. Assign a meaningful name for bit 1 of the control word that requests the SS1 safety function, e.g. `SS1_Request`.

8.4.5 Transmitting the configuration

Transmit the configuration of your TIA project from your PC to your controller.

- ✓ You have fully mapped and parameterized your PROFINET network in the TIA project.
- 1. Project navigation > Devices tab:
Select the folder of the controller in question.
- 2. Select Online > Advanced download to device in the menu bar.
⇒ The Advanced download window opens.
- 3. Select target device area:
Select Show all compatible nodes and click on Start search.
⇒ All controllers are listed that were found in the subnet.
- 4. Select the controller where you would like to transfer the configuration and click on Download.
⇒ The Software synchronization before downloading to a device window opens.
- 5. Click on Continue without synchronizing.
⇒ The Preview download window opens.
- 6. Click on Download.
⇒ The configuration is transmitted to the selected controller and the Results of the download process window opens.
- 7. Click on Finish.
⇒ The download process is complete; the configuration was transmitted successfully to the controller.

Information

If there is an online connection, you can identify which controller you have currently selected using Flash LED if multiple controllers are located in the same subnet.

Information

In DriveControlSuite, parameter A271 provides information about the state of the drive controller in the PROFINET network. If the application selected in DriveControlSuite does not match the inserted module in TIA Portal, the status 6: Configuration Application / PROFINE does not fit is output there.

- In this case, make sure that the device control and the PROFIdrive application are projected in DriveControlSuite and that a PROFIdrive module has been inserted in TIA Portal.

Information

Parameter A272 in DriveControlSuite provides information about the submodules projected in TIA Portal (display format: XXX YYY ZZZ; XXX = submodule ID (telegram no.), YYY = TxPZD data length in bytes, ZZZ = RxPZD data length in bytes).

8.4.6 Testing communication

Check the communication between the controller and drive controllers of your PROFINET network using the diagnostics buffer of the controller.

- ✓ You have transferred the configuration to the controller.
 - 1. Project tree > Devices tab:
Open the folder of the relevant controller.
 - 2. Double-click Online & diagnostics.
⇒ This switches you to the respective device view.
 - 3. Select Online access in the area navigation.
 - 4. Online access area:
Click on Go online.
⇒ An online connection to the selected controller is being established.
 - 5. In the area navigation, select Diagnostics > Diagnostics buffer.
 - 6. Results area:
Check the events in the diagnostics buffer for possible errors and correct their causes if necessary.
- ⇒ The connection between the controller and drive controller is projected and a data exchange between the nodes in the PROFINET network is possible.

Information

If there is an online connection, you can identify which controller you have currently selected using Flash LED if multiple controllers are located in the same subnet.

Information

Also observe the control and status information in the F-I/O DB of the safety module, such as for reintegration of the safety module after starting up the safety system (bit 4 ACK_REI).

The F-I/O DB of the safety module can be found in the Program blocks folder > System blocks > STEP 7 Safety > F-I/O DBs in the project navigation in TIA Portal.

Information

The safety technology configuration is completed. Continue by starting the programming of the safety program (main safety block).

Then, check the safety functions and document the results in a test report.

8.5 Checking safety functions

The SU6 safety module is a safety component in the sense of the Machinery Directive in accordance with Annex V. It guarantees functional safety, e.g. protection against errors in the hardware and firmware. However, it does not guarantee the safety of the entire process or the safety of the configuration.

The machine manufacturer must check and verify the functional capability of the safety functions used. The safety functions may only be checked by qualified personnel. The result of the check must be documented in a test report.

The check of the safety function must be performed:

- After initial commissioning
- After changing the configuration of the safety functions
- After exchanging the safety module or drive controller

A complete check includes:

- The proper execution of the safety functions used in the SU6 safety module
- The proper execution of the overall safety function (e.g. combination and integration of safety functions)
- A parameter check

The check is based on:

- The requirements for the safety functions of the SU6 safety module from the risk analysis of the machine or process
- The description of the SU6 safety module and its safety functions in accordance with this manual
- All safety-related parameters and values of the safety functions used

The test report must contain the following:

- A description of the application, including an image
- A description of the safety-related components (including software versions) that are used in the application
- A list of the safety functions used
- The results of all checks of these safety functions
- A list of all safety-related parameters and their values
- Checksums, test date and confirmation by the testing personnel

Safety tests in structurally identical applications may be performed as an individual type test of the identical application, provided that it can be ensured that the safety functions are configured in all devices as intended.

Information

The test must be repeated and it must be noted in the test report if parameters were changed that have an influence on the safety functions.

9 Diagnostics

In the event of fault, the various diagnostic options described below are available.

9.1 LED display

The drive controllers feature diagnostic LEDs that visualize the state of fieldbus communication and the states of the physical connection.

9.1.1 PROFINET state

There are 2 LEDs on the front of the drive controller that provide information about the connection between controller and drive controller and about the state of the data exchange. This information can also be read out in parameter A271 PN state.

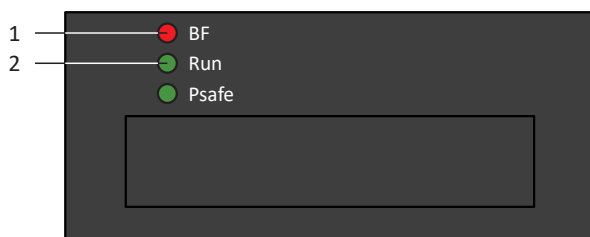

Fig. 6: LEDs for the PROFINET state

- 1 Red: BF (bus error)
- 2 Green: Run

Red LED	Conduct	Description
	Off	No error
	Rapid flashing	Data exchange with controller not active
	On	No network connection

Tab. 6: Meaning of the red LED (BF)

Green LED	Conduct	Description
	Off	No connection
	Single blink	Connection is set up to controller
	Single blink, inverse	Controller activates DHCP signal service
	Flashing	Existing connection to controller; data exchange expected
	On	Existing connection to controller

Tab. 7: Meaning of the green LED (Run)

9.1.2 PROFIsafe status

If the drive controller includes the SU6 safety module, the STO and SS1 safety functions are activated via PROFIsafe. In this case, an LED on the front of the device provides information about the status of PROFIsafe communication. This information can also be read out in parameter S40 PROFIsafe state.



Fig. 7: LEDs for the PROFIsafe status

1 Green: PROFIsafe

Green LED	Conduct	Description
	Off	Initialization
	Flashing	Ready for parameterization by controller (F-CPU)
	On	Normal operation
	Rapid flashing with 1x flash	Error in the safety-related communication settings
	Rapid flashing with 2x flash	Error in the safety-related application settings
	Rapid flashing with 3x flash	Incorrect PROFIsafe destination address
	Rapid flashing with 5x flash	Interruption of the PROFIsafe connection (watchdog error)
	Rapid flashing with 6x flash	Error in the transmission of the PROFIsafe data (CRC error)

Tab. 8: Meaning of the green LED (PROFIsafe status indicator in accordance with IEC 61784-3)

Information

Parameter S40 PROFIsafe state contains detailed information about the PROFIsafe communication status. The value of S40 can be read off in PROFINET wizard > Monitoring: PROFIsafe in DriveControlSuite.

9.1.3 PROFINET network connection

The Act. and Link LEDs at X200 and X201 on the top of the device indicate the state of the PROFINET network connection.

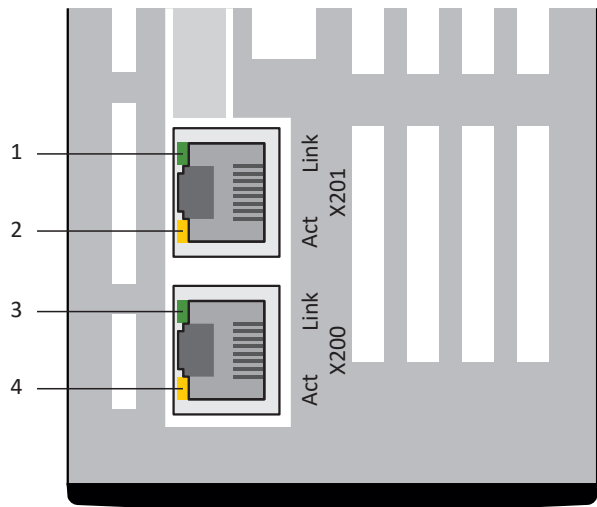





Fig. 8: LEDs for the state of the PROFINET network connection

- 1 Green: Link at X201
- 2 Yellow: Activity at X201
- 3 Green: Link at X200
- 4 Yellow: Activity at X200

Green LED	Conduct	Description
	Off	No network connection
	On	Network connection exists

Tab. 9: Meaning of the green LEDs (Link)

Yellow LED	Conduct	Description
	Off	No data exchange
	Flashing	Active data exchange with controller

Tab. 10: Meaning of the yellow LEDs (Act.)

9.2 Parameters

The following diagnostic parameters are available in the safety technology with drive controllers of the SC6 or SI6 series and SU6 safety module.

Information

In DriveControlSuite, the diagnostic parameters for the SU6 safety module are provided at a glance by PROFINET wizard > Monitoring: PROFIsafe.

9.2.1 E54 | Information safety module | G6 | V0

Signifying data of the safety module.

- [0]: Type
- [1]: Hardware version
- [2]: Production number
- [3] – [5]: Reserved
- [6]: Diagnostic code

9.2.2 E67 | STO state | G6 | V1

STO state of the safety module:

- [0]: STO requested by safety channel 1, safety channel 2, FSoE or PROFIsafe
Source: logical Or operation of E67[1], E67[2], FSoE and PROFIsafe including a deactivation delay of 32 ms
 - 0: Inactive = not requested
 - 1: Active = requested
- [1]: STO requested by safety channel 1
Source ST6, SR6: terminal X12.1/.2, signal $STO_a = 0$; source SE6, SY6, SU6: safety module-internal
 - 0: Inactive = not requested
 - 1: Active = requested
- [2]: STO requested by safety channel 2
Source ST6, SR6: terminal X12.3/.4, signal $STO_b = 0$; source SE6, SY6, SU6: safety module-internal
 - 0: Inactive = not requested
 - 1: Active = requested

9.2.3 S40 | PROFIsafe state | SI6 | V1

State of the transmission of safety-related data via PROFIsafe.

Normal

- 0 hex = Initialization
- 1 hex = Ready for parameterization by F-CPU
- 2 hex = Cyclical data exchange with PROFINET; PROFIsafe is active

Error

- 40 hex = Incorrect PROFIsafe address for the drive controller (F-device; S41)
- 41 hex = Impermissible PROFIsafe address for the drive controller (F-device; S41 = 0 hex or FFFF hex)
- 42 hex = Impermissible PROFIsafe address for the F-host (F-CPU: F_Source_Add = 0 hex or FFFF hex)
- 43 hex = Impermissible PROFIsafe watchdog time (S46 = 0)
- 45 hex = Maximum length of the payload does not match the configured length of the CRC checksum
- 46 hex = Invalid F-parameter version
- 47 hex = Incorrect F-parameter CRC checksum
- 48 hex = Device-specific error
- 4B hex = Inconsistent iParameters or incorrect F_iPar_CRC
- 4C hex = Impermissible block ID
- 4D hex = Inconsistent data transmission (CRC checksum)
- 4E hex = Timeout for the data transmission (PROFIsafe watchdog)

9.2.4 S41 | PROFIsafe address | SI6 | V1

Address of the drive controller (F-device) in the PROFIsafe network (prerequisite: F-host is active; source: DIP switch; TIA Portal: F_Dest_Add).

The address is available as soon as PROFINET communication has been established successfully (A271 = 5: Cyclical data exchange).

Address changes are applied when the drive controller is restarted.

9.2.5 S42 | Safety control word 1 | SI6 | V0

Control word for PROFIsafe.

Corresponds to the Safety control word 1 communication object (S_STW1) in acc. with PROFIsafe.

- [0]: First byte
 - Bit 0: STO
 - 0 = Activate STO; 1 = Do not activate STO
 - Bit 1: SS1
 - 0 = Activate SS1; 1 = Do not activate SS1
 - Bits 2 – 7: Reserved; value must be 0
- [1]: Second byte: Reserved

Enabling the power unit requires that bit 0 and bit 1 are set to 1.

9.2.6 S43 | Safety status word 1 | SI6 | V0

Status word for PROFIsafe.

Corresponds to the Safety status word 1 communication object (S_ZSW1) in acc. with PROFIsafe.

- [0]: First byte
 - Bit 0: STO
 - Bit 1: SS1
 - Bits 2 – 7: Reserved
- [1]: Second byte; reserved

If not otherwise specified: 0 = inactive; 1 = active.

9.2.7 S45 | PROFIsafe diagnosis | SI6 | V1

Status byte with diagnostic code of the safety module.

- Bits 0 – 1: Reserved
- Bit 2: PROFIsafe communication error
 - 1 = Connection between safety module and controller (F-CPU) is interrupted
- Bit 3: Reserved
- Bit 4: Overtemperature
- Bit 5: Reserved
- Bit 6: SS1 time
 - 0 = not running; 1 = running
- Bit 7: STO state
 - 1 = Safe STO state triggered over PROFIsafe

If not otherwise specified: 0 = inactive; 1 = active.

9.2.8 S46 | PROFIsafe watch dog time | SI6 | V0

Tolerated failure time of PROFIsafe telegrams for monitoring PROFIsafe communication (use: triggering internal STO; source: F-CPU).

PROFIsafe monitoring does not depend on PZD monitoring and is specified by the F-CPU of the controller using F_WD_Time (PZD monitoring: A109).

9.2.9 S47 | PROFIsafe SS1-time | SI6 | V1

Time between triggering a time-based SS1 and internally triggering the STO function (unit: 10 ms; source: F-CPU). The time-based SS1 is triggered by S42[0] Safety control word 1, bit 1.

The SS1 delay time is specified by the F-CPU of the controller (F-CPU: SS1 Delay Time). A change to the SS1 delay time in the F-CPU takes effect and becomes visible in parameter S47 the next time the controller is restarted.

9.3 Events

The drive controller has a self-monitoring system that uses test rules to protect the drive system from damage. Violating the test rules triggers a corresponding event. There is no possible way for you as the user to intervene in some events, such as the Short/ground event. In others, you can influence the effects and responses.

Possible effects include:

- Message: Information that can be evaluated by the controller
- Warning: Information that can be evaluated by the controller and becomes a fault after a defined time span has elapsed without the cause being resolved
- Fault: Immediate drive controller response; the power unit is disabled and axis movement is no longer controlled by the drive controller or the axis is brought to a standstill by a quick stop or emergency braking

ATTENTION!

Damage to property due to interruption of a quick stop or emergency braking!

If, when executing a quick stop or emergency braking, a fault occurs or STO is active, the quick stop or emergency braking is interrupted. In this case, the machine can be damaged by the uncontrolled axis movement.

Events, their causes and suitable measures are listed below. If the cause of the error is corrected, you can usually acknowledge the error immediately. If the drive controller has to be restarted instead, a corresponding note can be found in the measures.

Information

To make it easier for control programmers to set up the human-machine interface (HMI), a list of events and their causes can be found in the STOBER download center at <http://www.stoeber.de/en/downloads/>.

9.3.1 Event 50: Safety module

The drive controller is interrupted:

- The power unit is disabled and axis movement is no longer controlled by the drive controller
- The behavior of the brakes depends on the configuration of the safety module and an optional release override (F06)

Cause		Check and action
2: Wrong safety module	The projected E53 safety module does not match the E54[0] detected by the system	Check the project configuration and drive controller and correct the project configuration or exchange the drive controller if necessary; fault cannot be acknowledged
3: Internal error	Defective safety module	Exchange drive controller; fault cannot be acknowledged

Tab. 11: Event 50 – Causes and actions

9.3.2 Event 70: Parameter consistency

The drive controller is interrupted:

- The power unit is disabled and axis movement is no longer controlled by the drive controller
- The behavior of the brakes depends on the configuration of the safety module and an optional release override (F06)

The event is only triggered if the checking rules for Enable-on are violated.

Cause		Check and action
SU6 option: 15: Safety watchdog time	Monitoring of PZD timeout deactivated	Check the PZD timeout in the drive controller and activate it if necessary (A109 = 0 or 65535)
	Ratio of PROFIsafe watchdog time to PZD timeout too small	Check the PROFIsafe watchdog time in TIA Portal and PZD timeout in the drive controller; if necessary, increase the watchdog time or reduce the PZD timeout (guide value: PROFIsafe watchdog time = PZD timeout + PROFIsafe cycle time + 50 ms; S46 = A109 + S44 + 50 ms)

Tab. 12: Event 70 – Causes and actions

10 More information on PROFIsafe, safety functions and SU6?

This chapter summarizes the important terms, relationships and measures regarding PROFIsafe, the STO and SS1 safety functions and the SU6 safety module.

10.1 PROFIsafe

A safety protocol known as **PROFIsafe** exists in parallel with the Ethernet system **PROFINET** for the transmission of safety-related messages between PROFIsafe-capable devices in a network. The protocol is internationally standardized in accordance with the IEC 61784-3 standard. The design of PROFIsafe is based on the black channel principle.

Secure communication

During each PROFIsafe cycle, a safety controller (F-host) sends safety-related data to a drive controller (F-device) and simultaneously starts a watchdog timer. The drive controller acknowledges the received data and also begins runtime monitoring via a watchdog timer. The controller receives and processes the confirmation from the drive controller and stops the watchdog timer. If the data has been fully processed, the controller generates a new data packet.

Unique addressing

It must be possible to identify each drive controller using a unique PROFIsafe destination address.

The address is assigned to the drive controller using a DIP switch. A valid address is in the address range 1 – 254 (8 bit, the addresses 0 and 255 must not be assigned).

10.1.1 PROFIsafe telegram 30

For PROFIsafe communication between the controller and drive controller, PROFIsafe telegram 30 is used. Input data consists of 7 bytes and output data of 7 bytes, of which the first 2 bytes are assigned by the PROFIsafe control word (S_STW1) and PROFIsafe status word (S_ZSW1). The other 5 bytes are assigned by the PROFIsafe trailer, which contains the management information for PROFIsafe communication and is automatically read and written by the controller.

PROFIsafe control word (S_STW1)

The PROFIsafe control word is sent by the controller to the drive controller and contains information about whether the STO or SS1 safety functions are to be triggered in the drive controller. For triggering the safety functions, bit 0 and bit 1 of the control word are reserved and must be actuated with inverse logic.

Safety function	Bit	Value
STO	Bit 0	0 = Trigger STO
		1 = Do not trigger STO
SS1	Bit 1	0 = Trigger SS1
		1 = Do not trigger SS1
–	Bits 2 – 7	Reserved; value must be 0

PROFIsafe status word (S_ZSW1)

The PROFIsafe status word is sent by the drive controller to the controller and contains information about whether the STO or SS1 safety functions are active in the drive controller. Bit 0 and bit 1 of the status word are reserved for the status of the safety functions.

Safety function	Bit	Value
STO	Bit 0	0 = STO not active
		1 = STO active
SS1	Bit 1	0 = SS1 not active
		1 = SS1 active

10.2 Safety functions

The SU6 safety module supports the Safe Torque Off (STO) and Safe Stop 1 (SS1-t) safety functions. In order to move the axis, the safety controller must set both the STO and SS1 control bit of the drive controller. If only one of the two control bits is set, the drive controller remains in a safe state (STO active).

The safety functions relate to the device and are not axis-specific. This means that for multi-axis controllers, only the entire drive controller can be set to a safe state, not individual axes.

10.2.1 Safe Torque Off – STO

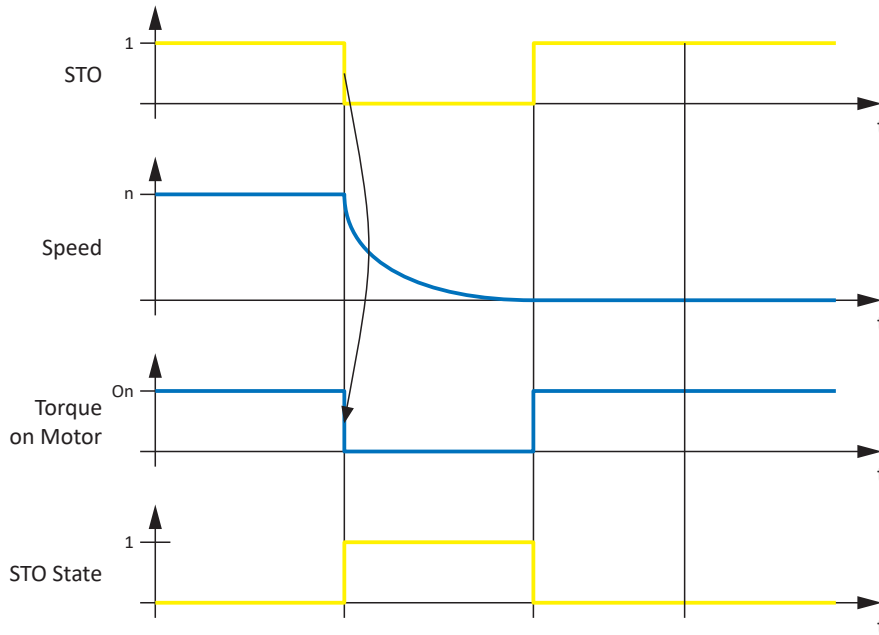

Fig. 9: STO function principle in accordance with ETG.6100.2

STO in accordance with EN 61800-5-2 corresponds to stop category 0 in accordance with EN 60204.

STO is the most fundamental drive-integrated safety function. STO prevents energy that generates torque from acting on the connected motor and prevents unintentional start-up. The goal is to safely eliminate material damage and injuries to persons caused by a rotating, unintentionally activated motor.

The use of STO is always suitable if the motor comes to a standstill on its own in a sufficiently short time period due to load torque or friction or in an environment in which motor coasting does not have safety-related implications.

10.2.2 Safe Stop 1 – SS1-t

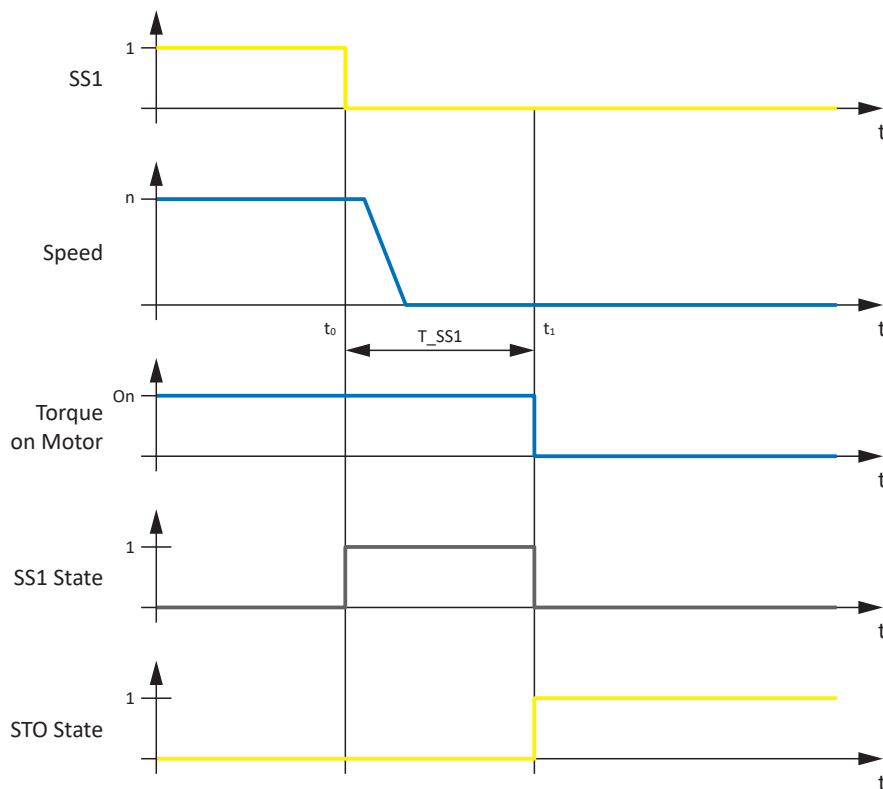

Fig. 10: SS1-t function principle in accordance with ETG.6100.2

t_0	SS1 activation
t_1	STO activation
T_{SS1}	SS1 delay time

SS1 in accordance with EN 61800-5-2 corresponds to stop category 1 in accordance with EN 60204-1.

In the case of SS1-t, the switch-off happens after a configurable amount of time.

The SS1-t safety function enables controlled stopping of a motor and switches it to a torque-free state after the parameterized SS1 delay time has passed, i.e. the STO safety function is activated. STO is triggered after a time delay, regardless of whether the motor has already reached a standstill.

WARNING!

Increased overrun distance! Residual motion!

The safety module cannot prevent a failure of the functional part of the drive controller (e.g. during a controlled stop) while the SS1-t safety function is executed. Therefore, SS1-t cannot be used if this failure could cause a dangerous situation in the end application. Observe this during project configuration.

In the event of an error in the power unit of the drive controller, static energization of the motor is possible despite active STO. In this case, the motor shaft can move by an angle of up to $360^\circ \div (p \times 2)$.

Information

Be aware that the drive controller continues to follow the set values of the controller during the SS1 delay time, which enables controlled stopping in multi-axis applications.

The SS1 delay time T_{SS1} is a safety-related parameter. The value of T_{SS1} is transmitted from the safety controller to the drive controller during the initialization of communication.

In DriveControlSuite, the value of T_{SS1} is shown in parameter S47 PROFIsafe SS1-time.

10.3 SU6: Assign the PROFIsafe destination address

To be able to identify the SU6 safety module uniquely in the PROFIsafe network, you must manually assign a PROFIsafe destination address to it from the address range 1 – 254 using S12 DIP switches on the top of the drive controller. The addresses 0 and 255 are invalid, i.e. when address 0 or 255 are assigned, the value is ignored and the SU6 safety module remains in the STO state.

Information

The drive controller must be switched off before you assign the address for the SU6 safety module using S12 DIP switches. The drive controller has to be restarted to apply the address.

Assigning the address using S12 DIP switches

The DIP switches for assigning the address are located on the top of the drive controller. The address is based on the values from the DIP switches that are switched ON. The following graphic shows DIP switches S12.2 and S12.4 in the ON state. Address 10 results from the associated values 2 and 8 of the DIP switches for the SU6 safety module.

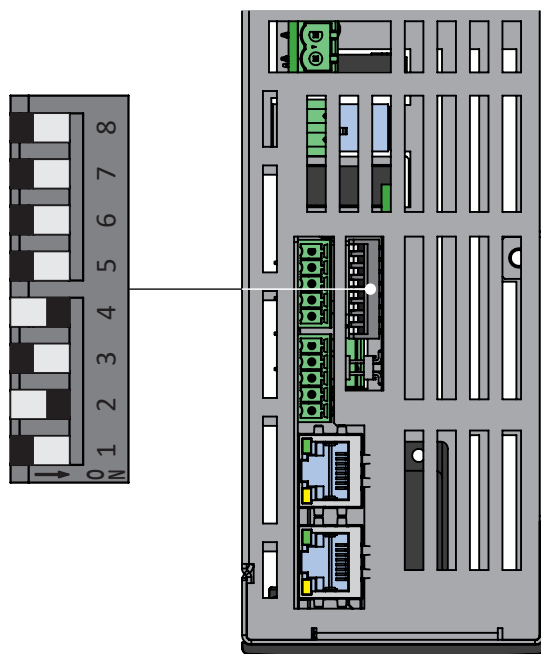

Fig. 11: SU6 – S12 DIP switches

S12 DIP switches	1	2	3	4	5	6	7	8
Value (address)	1	2	4	8	16	32	64	128

Tab. 13: S12 DIP switches and values

Checking the PROFIsafe destination address

The PROFIsafe destination address assigned by you for the SU6 safety module can be checked using parameter S41 PROFIsafe address in DriveControlSuite.

10.4 Safety system time

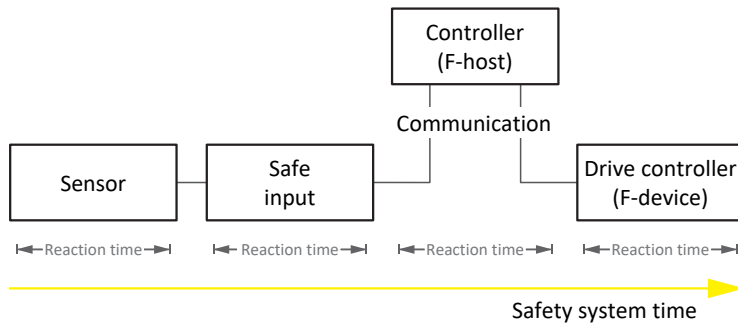

Fig. 12: Reaction times and safety system time

The safety system time is understood as the time span that passes from the request of a safety function to a sensor until the safety function is triggered on the drive controller.

The safety system time depends on the reaction times as well as communication and transmission times of the individual system components.

The reaction and communication times are produced from the following process:

- Sensor:
 - Provides the request signal
- Safe input:
 - Detects the request signal
- Controller (F-host):
 - Evaluates the request signal and transmits the request signal to the drive controller
- Drive controller (F-device):
 - Activates the safety function and deactivates it, if necessary (STO switch-off time); this process is divided as follows:
 - Processing in the control unit
 - Transmission of the data packet to the SU6 safety module
 - SU6: Evaluation of the data packet
 - Switch-off time of the power unit

10.5 Watchdog time

To detect possible faults, PROFIsafe communication is monitored between the controller (F-host) and drive controller (F-device) by a PROFIsafe watchdog. As soon as a safety telegram has been sent, both the controller and drive controller start the watchdog time. If the controller or drive controller do not receive a corresponding response message before the watchdog time runs out, the respective device switches into a safe state. The watchdog time is taken into account when calculating the worst case response time.

The watchdog time is parameterized individually for each drive controller in the controller.

In TIA Portal, a global watchdog time of 100 ms is set by default. If you would like to change the watchdog time, switch to the device configuration of the respective safety module in TIA Portal.

11 Appendix

11.1 Standard telegrams

11.1.1 Standard telegram 30: Process data

The following tables show the structure of PROFIsafe standard telegram 30 of the SU6 safety module.

The mapping of the process data is specified by the controller.

Information

More information about PROFIsafe telegram 30 can be found in the chapter [PROFIsafe telegram 30 \[► 59\]](#).

Byte	Data type	Name	Comment
0 – 1	WORD	Safety control word 1 (S_STW1)	Parameter S42
2 – 6	–	PROFIsafe trailer	–

Tab. 14: PROFIsafe RxPZD standard telegram 30

Byte	Data type	Name	Comment
0 – 1	WORD	Safety status word 1 (S_ZSW1)	Parameter S43
2 – 6	–	PROFIsafe trailer	–

Tab. 15: PROFIsafe TxPZD standard telegram 30

11.2 Detailed information

The documentation listed below provides you with further relevant information on the 6th STOBER drive controller generation. You can find the current status of the documentation in the STOBER download center at <http://www.stoerber.de/en/downloads/>, if you enter the ID of the documentation in the search.

Title	Documentation	Contents	ID
SC6 drive controller	Manual	System design, technical data, project configuration, storage, installation, connection, commissioning, operation, service, diagnostics	442790
Multi-axis drive system with SI6 and PS6	Manual	System design, technical data, project configuration, storage, installation, connection, commissioning, operation, service, diagnostics	442728
PROFINET communication – SC6, SI6	Manual	Installation, electrical installation, data transfer, commissioning, detailed information	443039
PROFIdrive application – SC6, SI6	Manual	Project configuration, configuration, parameterization, function test, detailed information	443270

The standards listed below are relevant for the SU6 safety module described in this documentation:

PROFIBUS Nutzerorganisation e. V. (PNO), 2019. *Amendment PROFIdrive on PROFIsafe – Interface for functional safety*. Technical specification for PROFIBUS and PROFINET. Version 3.1.0, February 2019.

PROFIBUS Nutzerorganisation e. V. (PNO), 2014. *PROFIsafe – Profile for Safety Technology on PROFIBUS DP and PROFINET IO*. Technical specification for PROFIBUS and PROFINET. Version 2.6.1, August 2014.

PROFIBUS Nutzerorganisation e. V. (PNO), 2007. *PROFIsafe – Profile for Safety Technology on PROFIBUS DP and PROFINET IO*. Technical specification for PROFIBUS and PROFINET. Version 2.4, March 2007.

PROFIBUS Nutzerorganisation e. V. (PNO), 2015. *Profile Drive Technology – PROFIdrive Profile*. Technical specification for PROFIBUS and PROFINET. Specification. Version 4.2, October 2015.

PROFIBUS Nutzerorganisation e. V. (PNO), 2010. *Overview and guidance for PROFINET specifications*. Technical specification for PROFINET. Version 2.3, October 2010.

PROFIBUS Nutzerorganisation e. V. (PNO), 2020. *Application layer services for decentralized periphery*. Technical specification for PROFINET. Version 2.4MU1, March 2020.

PROFIBUS Nutzerorganisation e. V. (PNO), 2020. *Application layer protocol for decentralized periphery*. Technical specification for PROFINET. Version 2.4MU1, March 2020.

IEC 61158-1:2019 : *Industrial communication networks – Fieldbus specifications – Part 1: Overview and guidance for the IEC 61158 and IEC 61784 series*. Standard. Version 2.0, April 2019.

IEC 61158-5-10:2019 : *Industrial communication networks – Fieldbus specifications – Part 5–10: Application layer service definition – Type 10 elements*. Standard. Version 4.0, April 2019.

IEC 61158-6-10:2019 : *Industrial communication networks – Fieldbus specifications – Part 6–10: Application layer protocol specification – Type 10 elements*. Standard. Version 4.0, June 2019.

IEC 61784-1:2019 : *Industrial communication networks – Profiles – Part 1: Fieldbus profiles*. Standard. Version 5.0, April 2019.

IEC 61784-1:2019 : *Industrial communication networks – Profiles – Part 2: Additional fieldbus profiles for real-time networks based on ISO/IEC/IEEE 8802-3*. Standard. Version 4.0, April 2019.

11.3 Formula symbols

Symbol	Unit	Explanation
p	–	Number of pole pairs
T _M	Year, a	Mission time

11.4 Abbreviations

μC	Microcontroller
CRC	Cyclic Redundancy Check
GSD	General Station Description data
IGBT	Insulated Gate Bipolar Transistor
I/O	Input/Output
PL	Performance Level
PLC	Programmable Logic Controller
PROFINET	Process Field Network
PWM	Pulse Width Modulation
PDS(SR)	Power Drive System(Safety Related)
PZD	Prozessdaten (process data)
RxPZD	Receive PZD (receive process data)
SIL	Safety Integrity Level
SIL CL	Safety Integrity Level Claim Limit
SRECS	Safety-Related Electrical Control System
SRP/CS	Safety-Related Part of a Control System
SS1	Safe Stop 1
SS1-t	Safe Stop 1-time
STO	Safe Torque Off
TIA	Totally Integrated Automation
TxPZD	Transmit PZD (transmit process data)

12 Contact

12.1 Consultation, service and address

We would be happy to help you!

We offer a wealth of information and services to go with our products on our website:

<http://www.stoeber.de/en/service>

For additional or personalized information, contact our consultation and support service:

<http://www.stoeber.de/en/support>

If you need our system support:

Phone +49 7231 582-3060

systemsupport@stoeber.de

If you need a replacement device:

Phone +49 7231 582-1128

replace@stoeber.de

Call our 24-hour service hotline:

Phone +49 7231 582-3000

Our address:

STÖBER Antriebstechnik GmbH + Co. KG

Kieselbronner Strasse 12

75177 Pforzheim, Germany

12.2 Your opinion is important to us

We created this documentation to the best of our knowledge with the goal of helping you build and expand your expertise productively and efficiently with our products.

Your suggestions, opinions, wishes and constructive criticism help us to ensure and further develop the quality of our documentation.

If you want to contact us for a specific reason, we would be happy to receive an e-mail from you at:

documentation@stoeber.de

Thank you for your interest.

Your STÖBER editorial team

12.3 Close to customers around the world

We offer you committed, expert advice and support in over 40 countries worldwide:

STOBER AUSTRIA

www.stoerber.at
+43 7613 7600-0
sales@stoerber.at

STOBER FRANCE

www.stoerber.fr
+33 478 98 91 80
sales@stoerber.fr

STOBER HUNGARY

www.stoerber.de
+36 53 5011140
info@emtc.hu

STOBER JAPAN

www.stoerber.co.jp
+81-3-5875-7583
sales@stoerber.co.jp

STOBER TAIWAN

www.stoerber.tw
+886 4 2358 6089
sales@stoerber.tw

STOBER UK

www.stoerber.co.uk
+44 1543 458 858
sales@stoerber.co.uk

STOBER CHINA

www.stoerber.cn
+86 512 5320 8850
sales@stoerber.cn

STOBER Germany

www.stoerber.de
+49 4 7231 582-0
sales@stoerber.de

STOBER ITALY

www.stoerber.it
+39 02 93909570
sales@stoerber.it

STOBER SWITZERLAND

www.stoerber.ch
+41 56 496 96 50
sales@stoerber.ch

STOBER TURKEY

www.stoerber.com
+90 216 510 2290
sales-turkey@stoerber.com

STOBER USA

www.stoerber.com
+1 606 759 5090
sales@stoerber.com

Glossary

Black channel principle

Technology that allows secure data to be transmitted over unsecure network or bus lines. Safety components can transmit safety-related data regardless of hardware using a secure protocol that tunnels through the underlying network channel. Possible transmission errors are noted in the standards IEC 61784-3 and IEC 61508.

Broadcast domain

Logical grouping of network devices within a local network that reaches all nodes via broadcast.

Category

In accordance with DIN EN ISO 13849-1: Classification of safety-related parts of a controller regarding their resistance to faults and their subsequent behavior in the event of a fault. A category is attained through the structure and the arrangement of parts, their fault detection and/or their reliability. Possible category designations, i.e. classifications, are B, 1, 2, 3, 4.

Control word

Parameter of the WORD data type (data width of 16 bits) that transmits control commands from the controller to the drive controller.

DIP switches

Switch in a closed design that contains two connection rows arranged in parallel with 1 – 12 switching units that can be switched independently of each other (DIP = dual in-line package).

F-CPU

Failsafe CPU in which a safety program can run in addition to the user program.

F-device

A decentralized field device that exchanges safety-relevant data cyclically with the F-host and is managed and controlled by it. An F-device consists of multiple modules and submodules. At STOBER, the F-device is a drive controller with the SU6 safety module for PROFIsafe functionality.

F-host

Data processing unit that runs the PROFIsafe protocol and requests the exchange of safety-relevant data with the F-slave.

F-OB

Failsafe block that is a component of the F-runtime group and calls the main safety block cyclically.

F-runtime group

Failsafe runtime group that at least consists of an F-OB and the main safety block and can include other failsafe blocks as an option.

GSD file

Includes the technical features of a PROFINET IO device (type, configuration data, parameters, diagnostic information, etc.) in XML format in accordance with the GSDML specification. A GSD file serves as the configuration basis for project configuration systems and is generally provided by the respective device manufacturer.

Insulated Gate Bipolar Transistor (IGBT)

Bipolar transistor with insulated gate electrode. Four-layer semiconductor component that is controlled using a gate and combines the advantages of bipolar and field-effect transistor. An IGBT is primarily used in power electronics.

IO controller

Generally, a programmable logic controller that controls automation tasks and regulates data communication.

IO device

A decentralized field device that is assigned logically to a PROFINET IO controller that manages and controls it. An IO device consists of multiple modules and submodules.

IPv4 limited broadcast

Type of broadcast in a network with IPv4 (Internet Protocol version 4). The IP address 255.255.255.255 is entered as the destination. The content of the broadcast is not forwarded by a router, which limits it to the local network.

MAC address

Hardware address for unique identification of a device in an Ethernet network. The MAC address is assigned by the manufacturer and consists of a 3-byte manufacturer ID and 3-byte device ID.

Main safety block

Failsafe function block (F-FB) that is a component of the F-runtime group and that contains the actual safety program that is called up by the F-OB.

Mission time (TM)

In accordance with DIN EN 61800-5-2: Determined cumulative length of operation of the PDS(SR) during its overall service life.

Performance Level (PL)

In accordance with DIN EN ISO 13849-1: Measure for the reliability of a safety function or a component. The Performance Level is measured on a scale of a – e (lowest – highest PL). The higher the PL, the safer and more reliable the function in question is. The PL can be assigned to a specific SIL. A reversed inference from a SIL to a PL is not possible.

Probability of a dangerous failure per hour (PFHD)

In accordance with DIN EN 61508/DIN EN 62061: Average probability of a dangerous device failure per hour. Together with PFH, one of the most important bases for calculating the safety function reliability of devices, the SIL.

PROFIdrive

Standardized drive interface for PROFIBUS and PROFINET open standard buses. It defines the device behavior and the procedure for accessing internal device data for electrical drives on PROFINET and PROFIBUS. The interface is specified by PROFIBUS and PROFINET International (PI) user organizations, and is specified as the future-proof standard by standard IEC 61800-7-303.

PROFINET

Open Ethernet standard of PROFIBUS Nutzerorganisation e. V. (PNO) for automation.

PROFIsafe

Communication standard for safety standard IEC 61508 that includes both standard as well as fail-safe communication. The standard enables reliable communication for PROFIBUS and PROFINET open standard buses based on standard network components, and is defined as the international standard in standard IEC 61784-3-3.

PROFIsafe address

Address that uniquely identifies a node in the PROFIsafe network. From the view of the controller, the PROFIsafe source address of the controller and the PROFIsafe destination address of the safety module are distinguished. The address is generally configured on the device itself, for example, using a DIP switch.

Safe Stop 1 (SS1)

In accordance with DIN EN 61800-5-2: Procedure for stopping a PDS(SR). With the SS1 safety function, the PDS(SR) performs one of the following functions: a) Triggering and controlling the motor delay variable within defined limits and triggering the STO function if the motor speed falls below a specified limit value (SS1-d), or b) triggering and monitoring the motor delay variable within defined limits and triggering the STO function if the motor speed falls below a specified limit value (SS1-r), or c) triggering the motor delay and triggering the STO function after an application-specific delay (SS1-t). In this case, SS1(-t) corresponds to the time-controlled stop in accordance with IEC 60204-1, stop category 1(-t).

Safe Torque Off (STO)

In accordance with DIN EN 61800-5-2: Procedure for stopping a PDS(SR). The STO safety function prevents the motor from being supplied with any energy that could cause rotation (or motion in a linear motor). The PDS(SR) does not supply the motor with any energy that could generate torque (or force in a linear motor). STO is the most fundamental drive-integrated safety function. It corresponds to an uncontrolled stop in accordance with DIN EN 60204-1, stop category 0.

Safety function

In accordance with DIN EN 61800-5-2: Function with a certain safety-related capability that is carried out in whole or in part by a PDS(SR) and with which the safe state of a system is maintained or the development of hazardous states in the system is prevented.

Safety Integrity Level (SIL)

In accordance with DIN EN 61800-5-2: Probability of a safety function failure. SIL is divided into levels 1 – 4 (lowest – highest level). SIL precisely assesses systems or subsystems based on the reliability of their safety functions. The higher the SIL, the safer and more reliable the function in question is.

Safety Integrity Level Claim Limit (SIL CL)

Maximum SIL that can be claimed, based on the structural limitations and systematized safety integrity of a SRECS subsystem. A SIL CL is determined by the hardware fault tolerance (HFT) and the safe failure fraction (SFF) of the subsystems.

Safety module

Accessory for drive controllers that enables the use of safety functions.

Status word

Parameter of the WORD data type (data width of 16 bit) that transmits the status information from the drive controller to the controller.

STO switch-off time

Time span starting from the activation of the safety function until the power unit of the drive controller is safely switched off.

Watchdog

Function that is used for cyclical monitoring of devices, connections or software. In STOBER, the watchdog is used to identify a communication failure between the controller and drive controller and activates in case of a timeout where no data exchange has taken place between the devices before the watchdog time expired.

Watchdog time

Time before the expiration of which a data exchange between two instances or devices must have taken place. If the watchdog time is exceeded without a data exchange taking place, the watchdog is triggered.

Worst case response time

Maximum time span required in order to switch off the actuator in the event of an error.

List of figures

Fig. 1	Components of the PROFIsafe-based safety concept	13
Fig. 2	DS6: Program interface	17
Fig. 3	DriveControlSuite: Navigation using text links and symbols	19
Fig. 4	TIA Portal: Program interface of the portal view	20
Fig. 5	TIA Portal: Program interface of the project view	21
Fig. 6	LEDs for the PROFINET state	50
Fig. 7	LEDs for the PROFIsafe status	51
Fig. 8	LEDs for the state of the PROFINET network connection	52
Fig. 9	STO function principle in accordance with ETG.6100.2	60
Fig. 10	SS1-t function principle in accordance with ETG.6100.2.....	61
Fig. 11	SU6 – S12 DIP switches	63
Fig. 12	Reaction times and safety system time.....	64

List of tables

Tab. 1	Correlation of STOBER terminology to PROFINET and PROFIsafe	9
Tab. 2	SU6 – Key safety-related figures	15
Tab. 3	Parameter groups.....	22
Tab. 4	Parameters: data types, parameter types, possible values	23
Tab. 5	Parameter types.....	24
Tab. 6	Meaning of the red LED (BF)	50
Tab. 7	Meaning of the green LED (Run)	50
Tab. 8	Meaning of the green LED (PROFIsafe status indicator in accordance with IEC 61784-3)	51
Tab. 9	Meaning of the green LEDs (Link)	52
Tab. 10	Meaning of the yellow LEDs (Act.)	52
Tab. 11	Event 50 – Causes and actions	56
Tab. 12	Event 70 – Causes and actions	57
Tab. 13	S12 DIP switches and values	63
Tab. 14	PROFIsafe RxPZD standard telegram 30.....	65
Tab. 15	PROFIsafe TxPZD standard telegram 30.....	65



4 4 3 2 5 8 . 0 1

04/2023

STÖBER Antriebstechnik GmbH + Co. KG
Kieselbronner Str. 12
75177 Pforzheim
Germany
Tel. +49 7231 582-0
mail@stoeber.de
www.stober.com

24 h Service Hotline
+49 7231 582-3000

www.stober.com